

CATALOGUE 2010

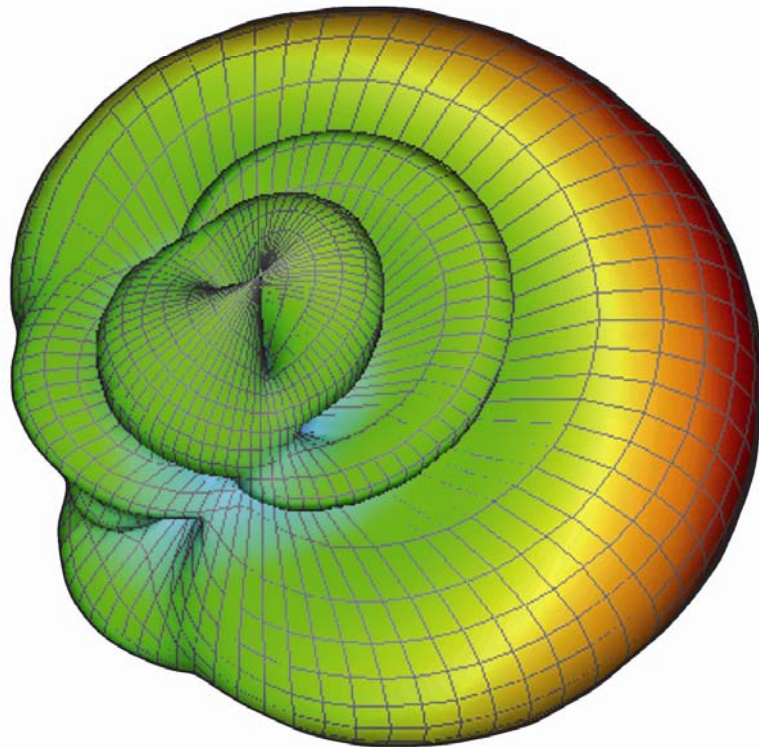

**BASE STATION ANTENNAS
CATALOGUE 2010**

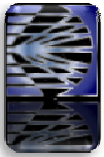



ABOUT RYMSA

The RYMSA Corporation designs, manufactures and distributes a wide range of sophisticated antennas and components for the telecommunications industry supplying technical solutions tailored to the needs of its clients around the world. In operation for over 30 years, RYMSA has earned critical renown for its high performance microwave and radio frequency products that have been deployed in Broadcast, Telecom and Space communications projects.

With production and design facilities in Spain, the United States and Mexico, RYMSA provides innovative technical solutions tailored to meet the needs of its clients around the world.

Innovation, Performance and Quality are our main identity.

RYMSA TELECOM DIVISION'S MISSION

With years of experience and know-how, RYMSA Telecom provides simple solutions for complex wireless antenna problems, developing antennas for all of the major worldwide mobile communications standards with a cutting-edge technology.

Leading-edge engineering innovations includes:

- Protecta TM single-piece radome, designed to provide structural integrity, While offering a longlasting protection from the elements.
- TruePol TM antenna cavity and dipole system designed to yield excellent cross-polar discrimination, gain, front-to-back ratio, and pattern symmetry for superior broadband performance.
- AccuPatternTM phase shifter, allowing a wide range of beam tilt adjustments while maintaining sidelobe suppression

Today, the Telecom division develops antennas for all the major standards and bandwidths of wireless telephony: AMPS, Cellular 850, GSM 900, DCS 1800, PCS 1900, UMTS, AWS, etc. Our overriding technical performance objectives are:

- Perfect the integrity and uniformity of coverage patterns
- Maximize consistent signal strength in all areas of the cell to enable operators to make a full use of capacity without degrading voice quality.

Optimize the electrical performance of our antennas, while minimizing tower loading and visual impact and reducing installation and operating expenses.
enable co-siting of multiple services

The company's extensive portfolio includes:

- Panel antennas: Single-band and Multi-band antennas (Dual-Band, Tri-Band, Quad-Band, Pentaband)
- Indoor antennas and repeaters
- Roof-top and monopole antennas: Tri-sector multi-radome, Tri-sector mono-radome with integrated masts
- Remote Electrical Tilt system: the "RET" and the site control unit (SCU)

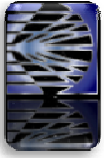

ABOUT RYMSA

EXCEPTIONAL QUALITY AND RELIABILITY

RYMSA Telecom is thoroughly committed to a total customer satisfaction. Our exceptionally responsive customer service representatives make it easy to track orders and coordinate deliveries to ensure on-time installation. Skilled technical experts are available to answer any installation question and support installation crews.

Finished products are subjected to a variety of punishing tests using the most modern tools: indoor (anechoic chamber) and outdoor pattern test ranges, environmental tests (temperature and humidity, corrosion, vibration, rain, wind resistance).

100% RYMSA antennas are tested for passive intermodulation (PIM), VSWR and near field pattern, ensuring that every antenna works dependably at peak performance

RYMSA manufactures in strict accordance with the ISO 9001 Quality Management System.

ENVIRONMENTAL POLICY

Environmental Protection is a commitment that RYMSA assumes, providing an environmental policy which is applicable to all activities of the Company.

The Company understands that all activities and products which are produced by Rymsa have the potential to impact the environment and the company is committed to:

- Reduce and eliminate, wherever possible, adverse impacts on the environment such as waste and sewage.
- Prevent pollution
- Promote the rational use of energy and natural resources
- Establish a variety of objectives and programs that promote continuous improvement.

This policy is carried out through the establishment and maintenance of an Environmental Management System to guarantee that every single activity in the Company will include due consideration of the related environmental aspects and targets will be set for continuous improvement.

This policy is carried out through the establishment and maintenance of an Environmental Management System to guarantee that every single activity in the Company will include due consideration of the related environmental aspects and targets will be set for continuous improvement.

TEMPERATURE RANGE

All RYMSA antennas are designed and manufactured to operate at a Temperature range of -55° to 60° (-67° to 140° F).

SUMMARY

1. SINGLE-BAND PANEL ANTENNA

1.1 BAND 700	5
1.2 BAND 850	19
1.3 BAND 900	39
1.4 BROADBAND 1710 – 2170.....	58

2. LOW BAND SIDE BY SIDE PANEL ANTENNA

2.1 BAND 900	76
--------------------	----

3. HIGH BAND SIDE BY SIDE PANEL ANTENNA

3.1 2 X BROADBAND 1710 – 2170 MHz.....	79
--	----

4. MULTI-BAND PANEL ANTENNA

4.1 DUAL-BAND	84
4.1.1 BAND 850 + BAND 1850 – 2170 MHz	
4.1.2 BAND 850 + BROADBAND 1710 – 2170 MHz	
4.1.3 BAND 900 + BROADBAND 1710 – 2170 MHz	
4.2 QUAD-BAND	95
4.2.1 2 X BAND 850 + 2 X BAND 1850 – 2170 MHz	
4.2.2 2 X BAND 850 + 2 X BROADBAND 1710 – 2170 MHz	
4.3 TRIPLE-BAND	98
4.3.1 BAND 850 + 2 X BROADBAND 1710 – 2170 MHz	
4.3.2 BAND 900 + 2 X BROADBAND 1710 – 2170 MHz	
4.3.3 3 X BROADBAND 1710 – 2170 MHz	
4.4 TETRA-BAND	104
4.4.1 4 X BROADBAND 1710 – 2170 MHz	
4.4.2 BAND 900 + 3 X BROADBAND 1710 – 2170 MHz	
4.4.3 2 X BAND 900 + 2 X BROADBAND 1710 – 2170 MHz	
4.5 PENTA-BAND	108
4.5.1 BAND 900 + 4 X BROADBAND 1710 – 2170 MHz	
4.5.2 2 X BAND 900 + 3 X BROADBAND 1710 – 2170 MHz	

5. TRI-SECTOR

5.1 BROADBAND 1710 – 2170 MHz	111
5.2 HIGH BAND SIDE BY SIDE.....	117
5.3 DUAL BAND.....	119
5.4 TRIPLE BAND.....	127

6. RYMSA FLEXIBLE POLE.....	131
7. REPEATER	
7.1 YAGI BAND 900	137
7.2 LOG PERIODIC BAND 900	140
8 UHF	
8.1 MOBILE ANTENNA	143
8.2 DISCONE ANTENNA	144
9 VHF	
9.1 LOADED ANTENNA.....	145
10 RET SYSTEMS.....	147
11 CLAMPS.....	157



SINGLE-BAND PANEL ANTENNA

BAND 700

SINGLE-BAND PANEL ANTENNA								
BAND 700								
Frequency	HBW	VBW	Gain (dbi)	Polarization	Tilt	Height mm (in)	Model	Page
698-896	65°	15°	14.2	Vertical	Fixed 0°, 2°, 4°, 6°	1275 (50)	AT39-643TX	6
698-896	65°	10°	16	Vertical	Fixed 0°, 2°, 4°, 6°	1990 (78)	AT39-663TX	7
698-896	65°	10°	16.5	Vertical	Fixed 0°, 2°, 4°, 6°	2530 (100)	AT39-683TX	8
698-896	90°	10°	14.5	Vertical	Fixed 0°, 2°, 4°, 6°	1990 (78)	AT39-665TX	9
698-896	90°	10°	15.2	Vertical	Fixed 0°, 2°, 4°, 6°	2530 (100)	AT39-685TX	10
698-896	65°	15°	13.7	± 45°	Variable 0°- 8°	1275 (50)	AT39-644TV	11
698-896	65°	15°	14.2	± 45°	Fixed 0°, 2°, 4°, 6°	1275 (50)	AT39-644TX	12
698-896	65°	10°	15.5	± 45°	Variable 0°- 10°	1990 (78)	AT39-664TV	13
698-896	65°	10°	16	± 45°	Fixed 0°, 2°, 4°, 6°	1990 (78)	AT39-664TX	14
698-896	65°	10°	16.7	± 45°	Fixed 0°, 2°, 4°, 6°	2530 (100)	AT39-684TX	15
698-896	65°	10°	16.2	± 45°	Variable 1°- 9°	2530 (100)	AT39-684TV	16
698-896	90°	10°	14.5	± 45°	Fixed 0°, 2°, 4°, 6°	1990 (78)	AT39-666TX	17
698-896	90°	10°	15	± 45°	Fixed 0°, 2°, 4°, 6°	2530 (100)	AT39-686TX	18



SINGLE-BAND PANEL ANTENNA

BAND 700

AT39-643TX

698 - 896

H71° V16°

Fixed Tilt 0°,2°,4°,6°

ELECTRICAL SPECIFICATIONS

BAND 700

Antenna Model	AT39-643TX
Polarization	Vertical
Frequency (MHz)	698-896
Horizontal Beamwidth	71°
Vertical Beamwidth	16°
Gain (dBi)	14.2
Vertical Electrical Tilt	FIXED 0°,2°,4°,6°
Upper Sidelobe Suppression for the 1 st lobe above main beam (dB)	18
Front-to-Back Ratio @ 180° ± 20° (dB)	25
VSWR	< 1.4 : 1
Maximum Power Per Input (W)	500
Intermodulation (dBc)	< - 150
Impedance (Ω)	50

MECHANICAL SPECIFICATIONS

Connectors	1 X 7/16 Female
Connector Position	Bottom
Survival Wind Speed km/h (mph)	200 (125)
Front Windload N @ 160 km/h (lbs @100 mph)	970 (220)
Lateral Windload N @ 160 km/h (lbs @100 mph)	195 (44)
Radome Color	Grey, paintable
Humidity	100%
Antenna Weight kg (lbs)	14 (30)
Antenna Dimension mm (in) H X W X D	1275 X 325 X 115 (50 X 13 X 5)

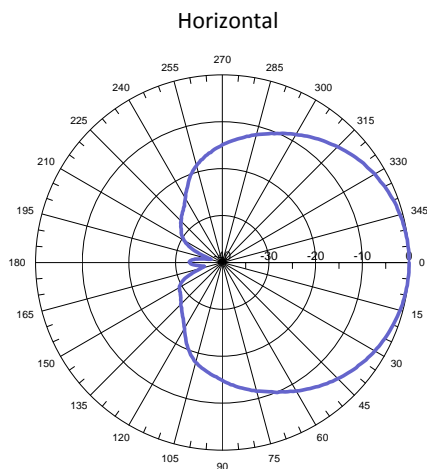

H&V Pattern

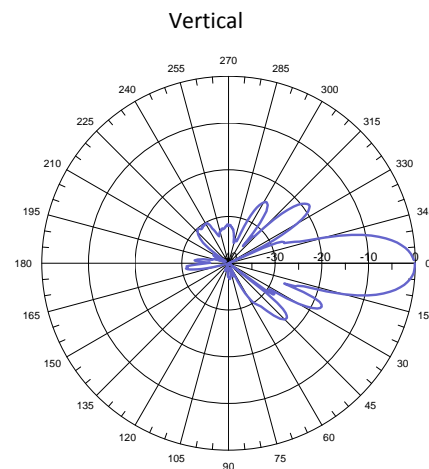

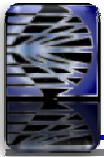

SINGLE-BAND PANEL ANTENNA

BAND 700

698 - 896

H70° V11°

Fixed Tilt 0°,2°,4°,6°

AT39-663TX

ELECTRICAL SPECIFICATIONS

BAND 700

Antenna Model	AT39-663TX
Polarization	Vertical
Frequency (MHz)	698-896
Horizontal Beamwidth	70°
Vertical Beamwidth	11°
Gain (dBi)	16
Vertical Electrical Tilt	FIXED 0°,2°,4°,6°
Upper Sidelobe Suppression for the 1 st lobe above main beam (dB)	20
Front-to-Back Ratio @ 180° ± 20° (dB)	28
VSWR	< 1.4 : 1
Maximum Power Per Input (W)	500
Intermodulation (dBc)	< - 150
Impedance (Ω)	50

MECHANICAL SPECIFICATIONS

Connectors	1 X 7/16 Female
Connector Position	Bottom
Survival Wind Speed km/h (mph)	200 (125)
Front Windload N @ 160 km/h (lbs @100 mph)	1045 (235)
Lateral Windload N @ 160 km/h (lbs @100 mph)	205 (46)
Radome Color	Grey, paintable
Humidity	100%
Antenna Weight kg (lbs)	19 (42)
Antenna Dimension mm (in) H X W X D	1990 X 325 X 115 (78 X 13 X 5)



Horizontal

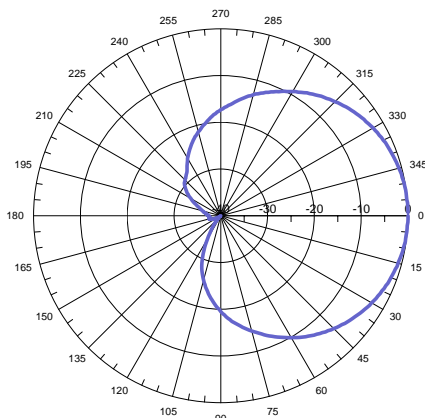

Vertical

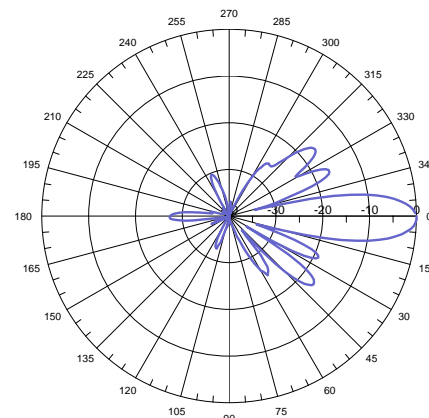

H&V Pattern

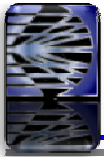

SINGLE-BAND PANEL ANTENNA

BAND 700

698 - 896

H70° V8°

Fixed Tilt 0°,2°,4°,6°

AT39-683TX

ELECTRICAL SPECIFICATIONS

BAND 700

Antenna Model	AT39-683TX
Polarization	Vertical
Frequency (MHz)	698-896
Horizontal Beamwidth	70°
Vertical Beamwidth	8°
Gain (dBi)	16.5
Vertical Electrical Tilt	FIXED 0°,2°,4°,6°
Upper Sidelobe Suppression for the 1 st lobe above main beam (dB)	18
Front-to-Back Ratio @ 180° ± 20° (dB)	28
VSWR	< 1.4 : 1
Maximum Power Per Input (W)	500
Intermodulation (dBc)	< - 150
Impedance (Ω)	50

MECHANICAL SPECIFICATIONS

Connectors	1 X 7/16 Female
Connector Position	Bottom
Survival Wind Speed km/h (mph)	200 (125)
Front Windload N @ 160 km/h (lbs @100 mph)	1350 (303)
Lateral Windload N @ 160 km/h (lbs @100 mph)	270 (61)
Radome Color	Grey, paintable
Humidity	100%
Antenna Weight kg (lbs)	22 (48)
Antenna Dimension mm (in) H X W X D	2530 X 325 X 115 (100 X 13 X 5)



Horizontal

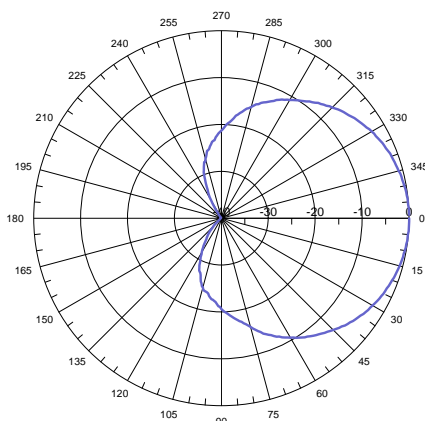

Vertical

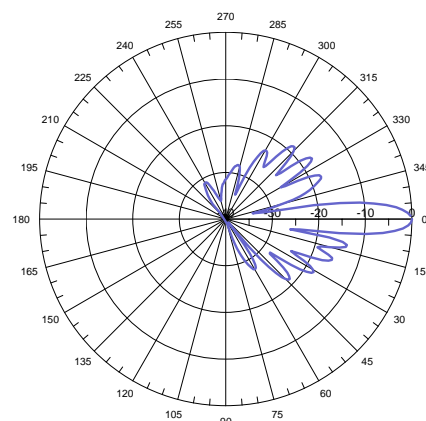

H&V Pattern

RYMSA Telecom Group (Headquarters)
 Ctra. Campo Real, km. 2.100
 28500 Arganda del Rey (Madrid)-Spain
 Phone : + 34 91 876 06 80
 Fax : + 34 91 875 75 32
 telecom.commercial@rymsa.com



RYMSA México: telecom.commercial@rymsa.com
 Phone: + 52 55 1106 2623
 RYMSA Wireless U.S.A: sales@rymsawireless.com
 Phone: + 1 888 622 6095
 www.rymsawireless.com

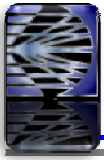

SINGLE-BAND PANEL ANTENNA

BAND 700

698 - 896

H90° V11°

Fixed Tilt 0°,2°,4°,6°

AT39-665TX

ELECTRICAL SPECIFICATIONS

BAND 700

Antenna Model	AT39-665TX
Polarization	Vertical
Frequency (MHz)	698-896
Horizontal Beamwidth	90°
Vertical Beamwidth	11°
Gain (dBi)	14.5
Vertical Electrical Tilt	FIXED 0°,2°,4°,6°
Upper Sidelobe Suppression for the 1 st lobe above main beam (dB)	17
Front-to-Back Ratio @ 180° ± 20° (dB)	25
VSWR	< 1.4 : 1
Maximum Power Per Input (W)	500
Intermodulation (dBc)	< - 150
Impedance (Ω)	50

MECHANICAL SPECIFICATIONS

Connectors	1 X 7/16 Female
Connector Position	Bottom
Survival Wind Speed km/h (mph)	200 (125)
Front Windload N @ 160 km/h (lbs @100 mph)	1045 (235)
Lateral Windload N @ 160 km/h (lbs @100 mph)	205 (46)
Radome Color	Grey, paintable
Humidity	100%
Antenna Weight kg (lbs)	19 (42)
Antenna Dimension mm (in) H X W X D	1990 X 325 X 115 (78 X 13 X 5)



Horizontal

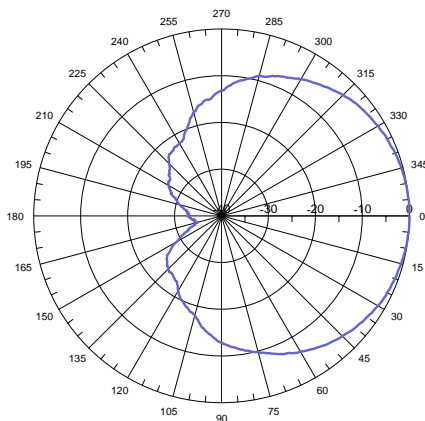

Vertical

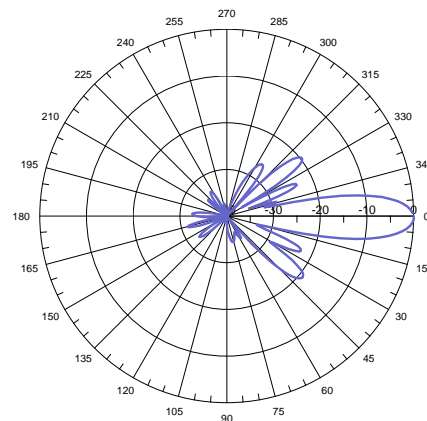

H&V Pattern

RYMSA Telecom Group (Headquarters)
 Ctra. Campo Real, km. 2.100
 28500 Arganda del Rey (Madrid)-Spain
 Phone : + 34 91 876 06 80
 Fax : + 34 91 875 75 32
 telecom.commercial@rymsa.com



RYMSA México: telecom.commercial@rymsa.com
 Phone:+ 52 55 1106 2623
 RYMSA Wireless U.S.A: sales@rymsawireless.com
 Phone: + 1 888 622 6095
 www.rymsawireless.com

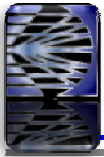

SINGLE-BAND PANEL ANTENNA

BAND 700

698 - 896

H90° V8.5°

Fixed Tilt 0°,2°,4°,6°

AT39-685TX

ELECTRICAL SPECIFICATIONS

BAND 700

Antenna Model	AT39-685TX
Polarization	Vertical
Frequency (MHz)	698-896
Horizontal Beamwidth	90°
Vertical Beamwidth	8.5°
Gain (dBi)	15.2
Vertical Electrical Tilt	FIXED 0°,2°,4°,6°
Upper Sidelobe Suppression for the 1 st lobe above main beam (dB)	18
Front-to-Back Ratio @ 180° ± 20° (dB)	25
VSWR	< 1.4 : 1
Maximum Power Per Input (W)	500
Intermodulation (dBc)	< -150
Impedance (Ω)	50

MECHANICAL SPECIFICATIONS

Connectors	1 X 7/16 Female
Connector Position	Bottom
Survival Wind Speed km/h (mph)	200 (125)
Front Windload N @ 160 km/h (lbs @100 mph)	1350 (303)
Lateral Windload N @ 160 km/h (lbs @100 mph)	270 (61)
Radome Color	Grey, paintable
Humidity	100%
Antenna Weight kg (lbs)	22 (48)
Antenna Dimension mm (in) H X W X D	2530 X 325 X 115 (100 X 13 X 5)



Horizontal

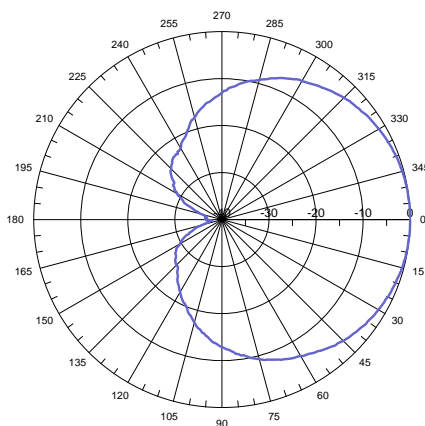

Vertical

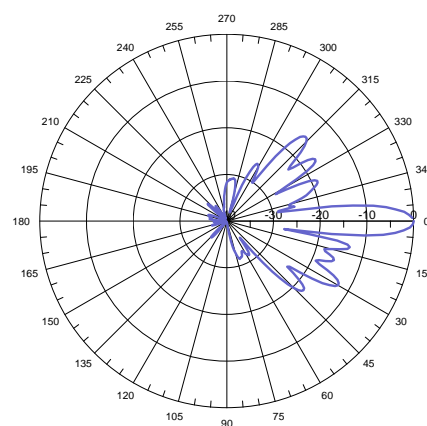

H&V Pattern

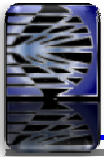

SINGLE-BAND PANEL ANTENNA

BAND 700

698 - 896

H67° V17°

Variable Tilt 0°-8°

AT39-644TV

ELECTRICAL SPECIFICATIONS

BAND 700

Antenna Model	AT39-644TV
Polarization	±45°
Frequency (MHz)	698-896
Horizontal Beamwidth	67°
Vertical Beamwidth	17°
Gain (dBi)	13.7
Vertical Electrical Tilt	VARIABLE 0°-8°
Upper Sidelobe Suppression for the 1 st lobe above main beam (dB)	15
Front-to-Back Ratio @ 180° ± 20° (dB)	> 25
VSWR	< 1.4 : 1
Cross Polar Ratio @ ± 60° (dB) <i>Typically</i>	9
Isolation Between Ports	> 30
Maximum Power Per Input (W)	500
Intermodulation (dBc)	< - 150
Impedance (Ω)	50



MECHANICAL SPECIFICATIONS

Connectors	2 X 7/16 Female
Connector Position	Bottom
Survival Wind Speed km/h (mph)	200 (125)
Front Windload N @ 160 km/h (lbs @100 mph)	970 (220)
Lateral Windload N @ 160 km/h (lbs @100 mph)	195 (44)
Radome Color	Grey, paintable
Humidity	100%
Antenna Weight kg (lbs)	15 (33)
Antenna Dimension mm (in) H X W X D	1275 X 325 X 115 (50 X 13 X 5)

Horizontal

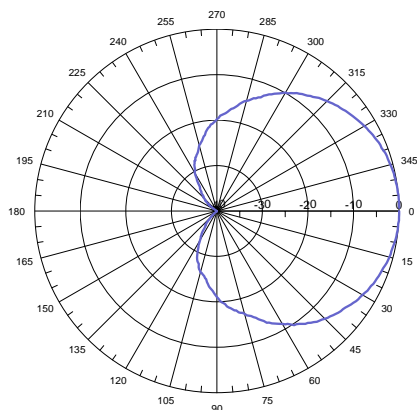

Vertical

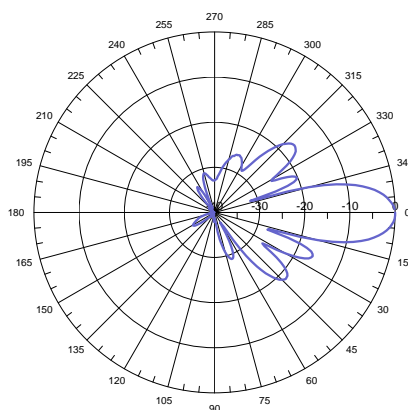

H&V Pattern

RYMSA Telecom Group (Headquarters)
 Crtra. Campo Real, km. 2.100
 28500 Arganda del Rey (Madrid)-Spain
 Phone : + 34 91 876 06 80
 Fax : + 34 91 875 75 32
 telecom.commercial@rymsa.com



RYMSA México: telecom.commercial@rymsa.com
 Phone: + 52 55 1106 2623
 RYMSA Wireless U.S.A: sales@rymsawireless.com
 Phone: + 1 888 622 6095
 www.rymsawireless.com

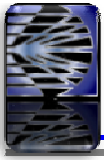

SINGLE-BAND PANEL ANTENNA

BAND 700

698 - 896

H65° V16.5

Fixed Tilt 0°,2°,4°,6°

AT39-644TX

ELECTRICAL SPECIFICATIONS

BAND 700

Antenna Model	AT39-644TX
Polarization	±45°
Frequency (MHz)	698-896
Horizontal Beamwidth	65°
Vertical Beamwidth	16.5°
Gain (dBi)	14.2
Vertical Electrical Tilt	FIXED 0°,2°,4°,6°
Upper Sidelobe Suppression for the 1 st lobe above main beam (dB)	18
Front-to-Back Ratio @ 180° ± 20° (dB)	30
VSWR	< 1.4 : 1
Cross Polar Ratio @ ± 60° (dB) <i>Typically</i>	10
Isolation Between Ports	> 30
Maximum Power Per Input (W)	500
Intermodulation (dBc)	< - 150
Impedance (Ω)	50

MECHANICAL SPECIFICATIONS

Connectors	2 X 7/16 Female
Connector Position	Bottom
Survival Wind Speed km/h (mph)	200 (125)
Front Windload N @ 160 km/h (lbs @100 mph)	970 (220)
Lateral Windload N @ 160 km/h (lbs @100 mph)	195 (44)
Radome Color	Grey, paintable
Humidity	100%
Antenna Weight kg (lbs)	14 (30)
Antenna Dimension mm (in) H X W X D	1275 X 325 X 115 (50 X 13 X 5)

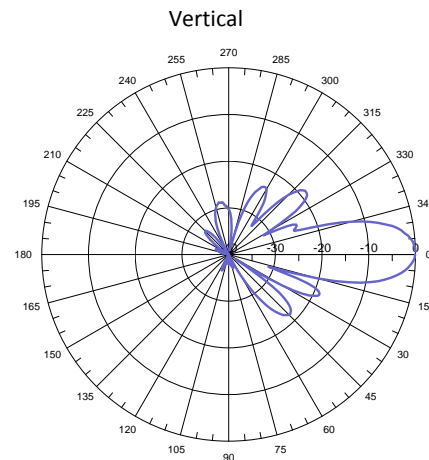
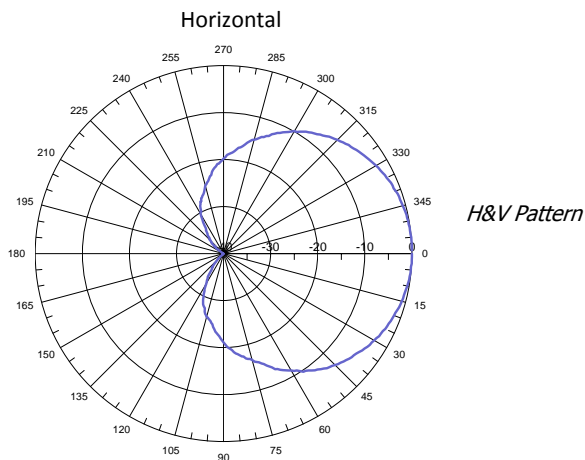

RYMSA Telecom Group (Headquarters)
 Ctra. Campo Real, km. 2.100
 28500 Arganda del Rey (Madrid)-Spain
 Phone : + 34 91 876 06 80
 Fax : + 34 91 875 75 32
 telecom.commercial@rymsa.com



RYMSA México: telecom.commercial@rymsa.com
 Phone: + 52 55 1106 2623
 RYMSA Wireless U.S.A: sales@rymsawireless.com
 Phone: + 1 888 622 6095
 www.rymsawireless.com



SINGLE-BAND PANEL ANTENNA

BAND 700

698 - 896

H68° V12°

Variable Tilt 0°-10°

AT39-664TV

ELECTRICAL SPECIFICATIONS

BAND 700

Antenna Model	AT39-664TV
Polarization	± 45°
Frequency (MHz)	698-896
Horizontal Beamwidth	68°
Vertical Beamwidth	12°
Gain (dBi)	15.5
Vertical Electrical Tilt	VARIABLE 0°-10°
Upper Sidelobe Suppression for the 1 st lobe above main beam (dB)	17
Front-to-Back Ratio @ 180° ± 20° (dB)	25
VSWR	< 1.4 : 1
Cross Polar Ratio @ ± 60° (dB) <i>Typically</i>	9
Isolation Between Ports	> 30
Maximum Power Per Input (W)	500
Intermodulation (dBc)	< -150
Impedance (Ω)	50



MECHANICAL SPECIFICATIONS

Connectors	2 X 7/16 Female
Connector Position	Bottom
Survival Wind Speed km/h (mph)	200 (125)
Front Windload N @ 160 km/h (lbs @100 mph)	1045 (235)
Lateral Windload N @ 160 km/h (lbs @100 mph)	205 (46)
Radome Color	Grey, paintable
Humidity	100%
Antenna Weight kg (lbs)	21 (47)
Antenna Dimension mm (in) H X W X D	1990 X 325 X 115 (78 X 13 X 5)

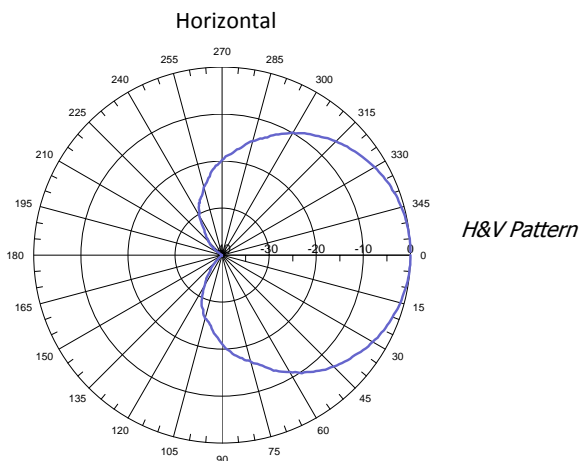

RYMSA Telecom Group (Headquarters)
 Ctra. Campo Real, km. 2,100
 28500 Arganda del Rey (Madrid)-Spain
 Phone : + 34 91 876 06 80
 Fax : + 34 91 875 75 32
 telecom.commercial@rymsa.com



RYMSA México: telecom.commercial@rymsa.com
 Phone: + 52 55 1106 2623
 RYMSA Wireless U.S.A: sales@rymsawireless.com
 Phone: + 1 888 622 6095
 www.rymsawireless.com

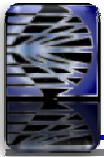

SINGLE-BAND PANEL ANTENNA

BAND 700

698 - 896

H67° V11°

Fixed Tilt 0°,2°,4°,6°

AT39-664TX

ELECTRICAL SPECIFICATIONS

BAND 700

Antenna Model	AT39-664TX
Polarization	± 45°
Frequency (MHz)	698-896
Horizontal Beamwidth	67°
Vertical Beamwidth	11°
Gain (dBi)	16
Vertical Electrical Tilt	FIXED 0°,2°,4°,6°
Upper Sidelobe Suppression for the 1 st lobe above main beam (dB)	18
Front-to-Back Ratio @ 180° ± 20° (dB)	30
VSWR	< 1.4 : 1
Cross Polar Ratio @ ± 60° (dB) <i>Typically</i>	9
Isolation Between Ports	> 30
Maximum Power Per Input (W)	500
Intermodulation (dBc)	< -150
Impedance (Ω)	50

MECHANICAL SPECIFICATIONS

Connectors	2 X 7/16 Female
Connector Position	Bottom
Survival Wind Speed km/h (mph)	200 (125)
Front Windload N @ 160 km/h (lbs @100 mph)	1045 (235)
Lateral Windload N @ 160 km/h (lbs @100 mph)	205 (46)
Radome Color	Grey, paintable
Humidity	100%
Antenna Weight kg (lbs)	19 (42)
Antenna Dimension mm (in) H X W X D	1990 X 324 X 113 (78 X 13 X 4)

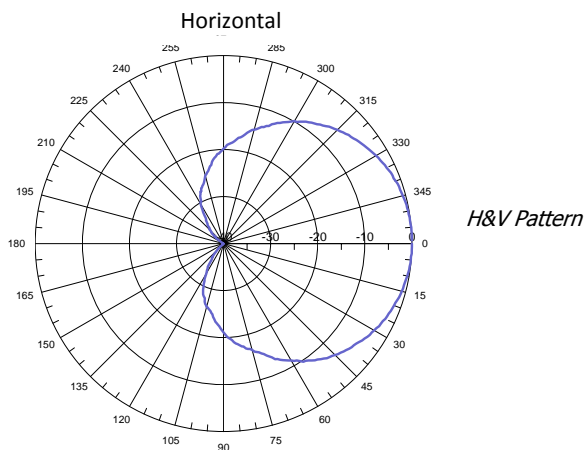

RYMSA Telecom Group (Headquarters)
 Ctra. Campo Real, km. 2.100
 28500 Arganda del Rey (Madrid)-Spain
 Phone : +34 91 876 06 80
 Fax : +34 91 875 75 32
 telecom.commercial@rymsa.com



RYMSA México: telecom.commercial@rymsa.com
 Phone: +52 55 1106 2623
 RYMSA Wireless U.S.A: sales@rymsawireless.com
 Phone: +1 888 622 6095
 www.rymsawireless.com

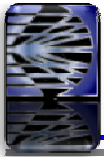

SINGLE-BAND PANEL ANTENNA

BAND 700

698 - 896

H67° V8°

Fixed Tilt 0°,2°,4°,6°

AT39-684TX

ELECTRICAL SPECIFICATIONS

BAND 700

Antenna Model	AT39-684TX
Polarization	± 45°
Frequency (MHz)	698-896
Horizontal Beamwidth	67°
Vertical Beamwidth	8°
Gain (dBi)	16.7
Vertical Electrical Tilt	FIXED 0°,2°,4°,6°
Upper Sidelobe Suppression for the 1 st lobe above main beam (dB)	17
Front-to-Back Ratio @ 180° ± 20° (dB)	30
VSWR	< 1.4 : 1
Cross Polar Ratio @ ± 60° (dB) <i>Typically</i>	10
Isolation Between Ports	> 30
Maximum Power Per Input (W)	500
Intermodulation (dBc)	< - 150
Impedance (Ω)	50

MECHANICAL SPECIFICATIONS

Connectors	2 X 7/16 Female
Connector Position	Bottom
Survival Wind Speed km/h (mph)	200 (125)
Front Windload N @ 160 km/h (lbs @100 mph)	1350 (303)
Lateral Windload N @ 160 km/h (lbs @100 mph)	270 (61)
Radome Color	Grey, paintable
Humidity	100%
Antenna Weight kg (lbs)	22 (48)
Antenna Dimension mm (in) H X W X D	2530 X 325 X 115 (100 X 13 X 5)

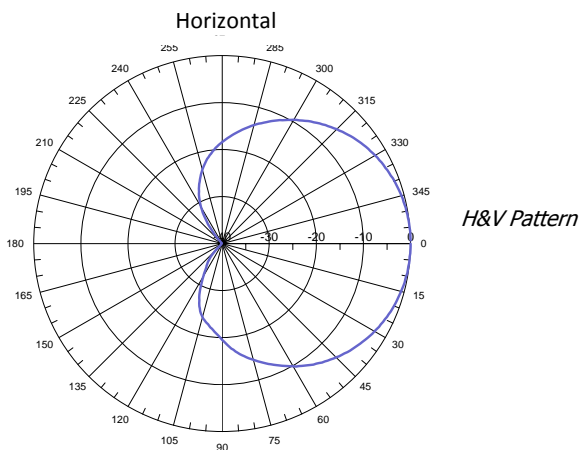

RYMSA Telecom Group (Headquarters)
 Ctra. Campo Real, km. 2.100
 28500 Arganda del Rey (Madrid)-Spain
 Phone : + 34 91 876 06 80
 Fax : + 34 91 875 75 32
 telecom.commercial@rymsa.com



RYMSA México: telecom.commercial@rymsa.com
 Phone:+ 52 55 1106 2623
 RYMSA Wireless U.S.A: sales@rymsawireless.com
 Phone: + 1 888 622 6095
 www.rymsawireless.com

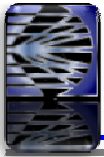

SINGLE-BAND PANEL ANTENNA

BAND 700

698 - 896

H67° V8.5°

Variable Tilt 1°- 9°

AT39-684TV

ELECTRICAL SPECIFICATIONS

BAND 700

Antenna Model	AT39-684TV
Polarization	± 45°
Frequency (MHz)	698-896
Horizontal Beamwidth	67°
Vertical Beamwidth	8.5°
Gain (dBi)	16.2
Vertical Electrical Tilt	VARIABLE 1°-9°
Upper Sidelobe Suppression for the 1 st lobe above main beam (dB)	15
Front-to-Back Ratio @ 180° ± 20° (dB)	27
VSWR	< 1.4 : 1
Cross Polar Ratio @ ± 60° (dB) <i>Typically</i>	7
Isolation Between Ports	> 30
Maximum Power Per Input (W)	500
Intermodulation (dBc)	< - 150
Impedance (Ω)	50



MECHANICAL SPECIFICATIONS

Connectors	2 X 7/16 Female
Connector Position	Bottom
Survival Wind Speed km/h (mph)	200 (125)
Front Windload N @ 160 km/h (lbs @100 mph)	1350 (303)
Lateral Windload N @ 160 km/h (lbs @100 mph)	270 (61)
Radome Color	Grey, paintable
Humidity	100%
Antenna Weight kg (lbs)	25 (55)
Antenna Dimension mm (in) H X W X D	2530 X 325 X 115 (100 X 13 X 5)

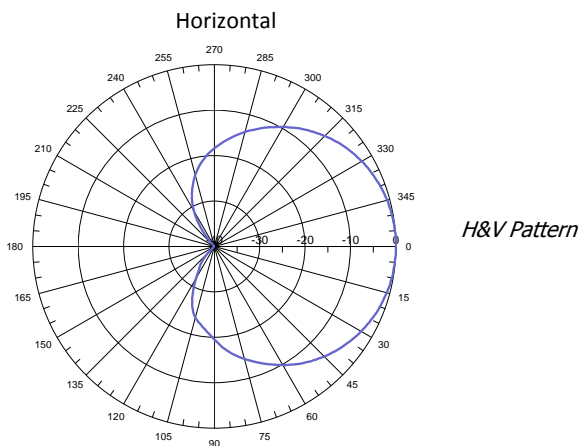

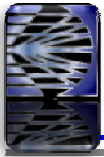

SINGLE-BAND PANEL ANTENNA

BAND 700

698 - 896

H90° V10°

Fixed Tilt 0°,2°,4°,6°

AT39-666TX

ELECTRICAL SPECIFICATIONS

BAND 700

Antenna Model	AT39-666TX
Polarization	± 45°
Frequency (MHz)	698-896
Horizontal Beamwidth	90°
Vertical Beamwidth	10°
Gain (dBi)	14.5
Vertical Electrical Tilt	FIXED 0°,2°,4°,6°
Upper Sidelobe Suppression for the 1 st lobe above main beam (dB)	18
Front-to-Back Ratio @ 180° ± 20° (dB)	20
VSWR	< 1.4 : 1
Cross Polar Ratio @ ± 60° (dB) <i>Typically</i>	10
Isolation Between Ports	> 30
Maximum Power Per Input (W)	500
Intermodulation (dBc)	< - 150
Impedance (Ω)	50

MECHANICAL SPECIFICATIONS

Connectors	2 X 7/16 Female
Connector Position	Bottom
Survival Wind Speed km/h (mph)	200 (125)
Front Windload N @ 160 km/h (lbs @100 mph)	1045 (235)
Lateral Windload N @ 160 km/h (lbs @100 mph)	205 (46)
Radome Color	Grey, paintable
Humidity	100%
Antenna Weight kg (lbs)	19 (42)
Antenna Dimension mm (in) H X W X D	1990 X 325 X 115 (78 X 13 X 5)

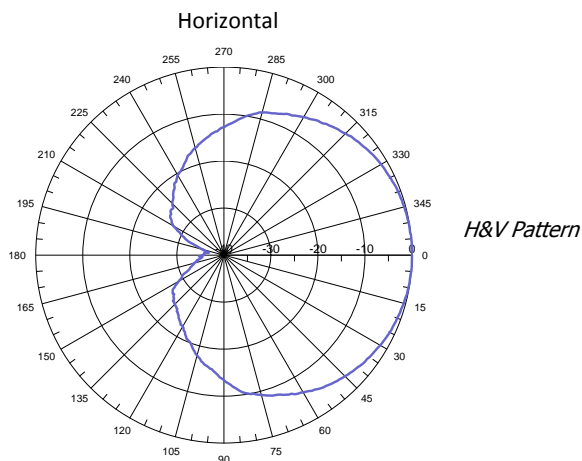

RYMSA Telecom Group (Headquarters)
 Ctra. Campo Real, km. 2.100
 28500 Arganda del Rey (Madrid)-Spain
 Phone : + 34 91 876 06 80
 Fax : + 34 91 875 75 32
 telecom.commercial@rymsa.com



RYMSA México: telecom.commercial@rymsa.com
 Phone: + 52 55 1106 2623
 RYMSA Wireless U.S.A: sales@rymsawireless.com
 Phone: + 1 888 622 6095
 www.rymsawireless.com

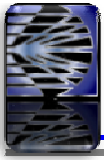

SINGLE-BAND PANEL ANTENNA

BAND 700

698 - 896

H90° V8.5°

Fixed Tilt 0°,2°,4°,6°

AT39-686TX

ELECTRICAL SPECIFICATIONS

BAND 700

Antenna Model	AT39-686TX
Polarization	± 45°
Frequency (MHz)	698-896
Horizontal Beamwidth	90°
Vertical Beamwidth	8.5°
Gain (dBi)	15
Vertical Electrical Tilt	FIXED 0°,2°,4°,6°
Upper Sidelobe Suppression for the 1 st lobe above main beam (dB)	17
Front-to-Back Ratio @ 180° ± 20° (dB)	20
VSWR	< 1.4 : 1
Cross Polar Ratio @ ± 60° (dB) <i>Typically</i>	10
Isolation Between Ports	> 30
Maximum Power Per Input (W)	500
Intermodulation (dBC)	< -150
Impedance (Ω)	50



MECHANICAL SPECIFICATIONS

Connectors	2 X 7/16 Female
Connector Position	Bottom
Survival Wind Speed km/h (mph)	200 (125)
Front Windload N @ 160 km/h (lbs @100 mph)	1350 (303)
Lateral Windload N @ 160 km/h (lbs @100 mph)	270 (61)
Radome Color	Grey, paintable
Humidity	100%
Antenna Weight kg (lbs)	22 (48)
Antenna Dimension mm (in) H X W X D	2530 X 325 X 115 (100 X 13 X 5)

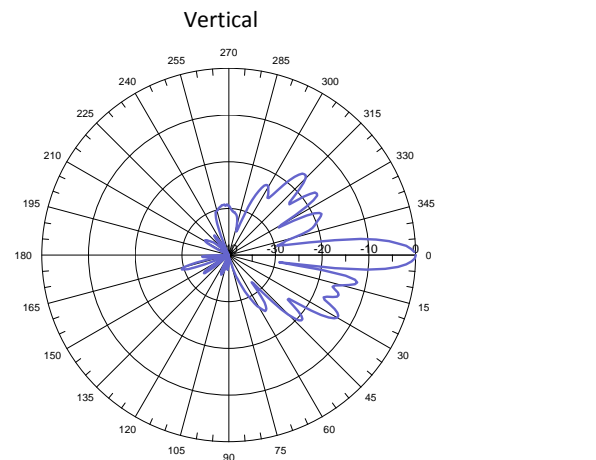
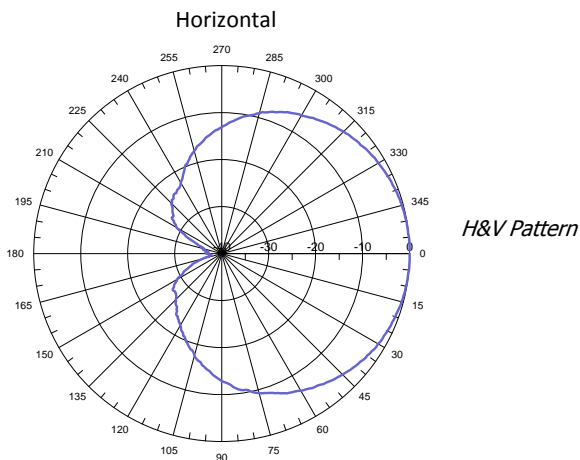

H&V Pattern

RYMSA Telecom Group (Headquarters)
 Crtra. Campo Real, km. 2.100
 28500 Arganda del Rey (Madrid)-Spain
 Phone : + 34 91 876 06 80
 Fax : + 34 91 875 75 32
 telecom.commercial@rymsa.com



RYMSA México: telecom.commercial@rymsa.com
 Phone: + 52 55 1106 2623
 RYMSA Wireless U.S.A: sales@rymsawireless.com
 Phone: + 1 888 622 6095
 www.rymsawireless.com



SINGLE-BAND PANEL ANTENNA

BAND 850

SINGLE-BAND PANEL ANTENNA								
BAND 850								
Frequency	HBW	VBW	Gain (dbi)	Polarization	Tilt	Height mm (in)	Model	Page
824 - 896	65°	15°	14.7	Vertical	Fixed 0°, 2°, 4°, 6°	1340 (53)	AT41-643TX	20
824 - 896	65°	10°	16.2	Vertical	Fixed 0°, 2°, 4°, 6°	1985 (78)	AT41-663TX	21
824 - 896	65°	6°	17.1	Vertical	Fixed 0°, 2°, 4°, 6°	2530 (100)	AT41-683TX	22
824 - 896	90°	15°	13.5	Vertical	Fixed 0°, 2°, 4°, 6°	1340 (53)	AT41-645TX	23
824 - 896	90°	10°	15	Vertical	Fixed 0°, 2°, 4°, 6°	1985 (78)	AT41-665TX	24
824 - 896	90°	6°	16	Vertical	Fixed 0°, 2°, 4°, 6°	2530 (100)	AT41-685TX	25
824 - 896	65°	6°	17.1	± 45°	Fixed 0°, 2°, 4°, 6°	2530 (100)	AT41-684TX	26
824 - 896	65°	7.5°	17	± 45°	Variable 0°- 8°	2530 (100)	AT41-684TV	27
824 - 896	65°	10°	16.2	± 45°	Fixed 0°, 2°, 4°, 6°	1985 (78)	AT41-664TX	28
824 - 896	65°	10°	16	± 45°	Variable 0°- 10°	1985 (78)	AT41-664TV	29
824 - 896	65°	15°	14.5	± 45°	Fixed 0°, 2°, 4°, 6°	1340 (53)	AT41-644TX	30
824 - 896	65°	15°	15	± 45°	Variable 0°- 10°	1340 (53)	AT41-644TV	31
824 - 896	90°	6°	16	± 45°	Fixed 0°, 2°, 4°, 6°	2530 (100)	AT41-686TX	32
824 - 896	90°	6°	15.5	± 45°	Variable 0°- 8°	2530 (100)	AT41-686TV	33
824 - 896	90°	10°	15	± 45°	Fixed 0°, 2°, 4°, 6°	1985 (78)	AT41-666TX	34
824 - 896	90°	10°	14.5	± 45°	Variable 0°- 10°	1985 (78)	AT41-666TV	35
824 - 896	90°	15°	13.5	± 45°	Fixed 0°, 2°, 4°, 6°	1340 (53)	AT41-646TX	36
824 - 896	90°	15°	13.5	± 45°	Variable 0°- 10°	1340 (53)	AT41-646TV	37
824 - 896	65°	6°	17	± 45°	Variable 0°- 8°	2530 (100)	ATR41-XXX	38

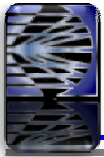

SINGLE-BAND PANEL ANTENNA

BAND 850

AT41-643TX

824 - 896

H64° V15°

Fixed Tilt 0°, 2°, 4°, 6°

ELECTRICAL SPECIFICATIONS

BAND 850

Antenna Model	AT41-643TX
Polarization	Vertical
Frequency (MHz)	824 - 896
Horizontal Beamwidth	64°
Vertical Beamwidth	15°
Gain (dBi)	14.7
Vertical Electrical Tilt	FIXED 0°, 2°, 4°, 6°
Upper Sidelobe Suppression for the 1 st lobe above main beam (dB)	20
Front-to-Back Ratio @180° ± 20° (dB)	> 27
VSWR	< 1.4 : 1
Maximum Power Per Input (W)	500
Intermodulation (dBc)	< - 150
Impedance (Ω)	50



MECHANICAL SPECIFICATIONS

Connectors	1 X 7/16 Female
Connector Position	Bottom
Survival Wind Speed km/h (mph)	200 (125)
Front Windload N @ 160 km/h (lbs @100 mph)	670 (150)
Lateral Windload N @ 160 km/h (lbs @100 mph)	130 (29)
Radome Color	Grey, paintable
Humidity	100%
Antenna Weight kg (lbs)	12 (26)
Antenna Dimension mm (in) H X W X D	1340 X 310 X 110 (53 X 12 X 4)

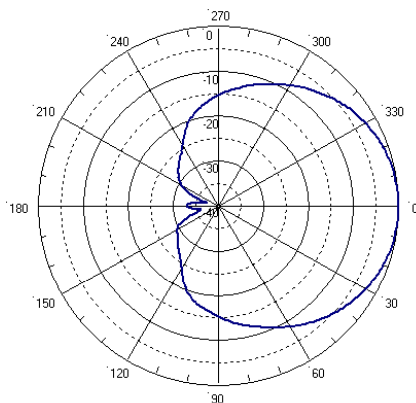

H&V Pattern

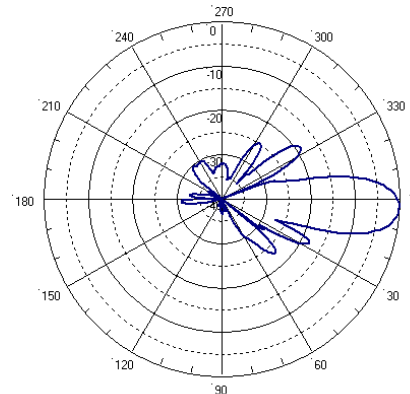

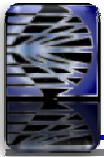

SINGLE-BAND PANEL ANTENNA

BAND 850

824 - 896

H64° V10.1°

Fixed Tilt 0°, 2°, 4°, 6°

AT41-663TX

ELECTRICAL SPECIFICATIONS

BAND 850

Antenna Model	AT41-663TX
Polarization	Vertical
Frequency (MHz)	824 - 896
Horizontal Beamwidth	64°
Vertical Beamwidth	10.1°
Gain (dBi)	16.2
Vertical Electrical Tilt	FIXED 0°, 2°, 4°, 6°
Upper Sidelobe Suppression for the 1 st lobe above main beam (dB)	18
Front-to-Back Ratio @180° ± 20° (dB)	> 30
VSWR	< 1.4 : 1
Maximum Power Per Input (W)	500
Intermodulation (dBc)	< - 150
Impedance (Ω)	50

MECHANICAL SPECIFICATIONS

Connectors	1 X 7/16 Female
Connector Position	Bottom
Survival Wind Speed km/h (mph)	200 (125)
Front Windload N @ 160 km/h (lbs @100 mph)	970 (220)
Lateral Windload N @ 160 km/h (lbs @100 mph)	200 (45)
Radome Color	Grey, paintable
Humidity	100%
Antenna Weight kg (lbs)	18 (39)
Antenna Dimension mm (in) H X W X D	1985 X 310 X 110 (78 X 12 X 4)

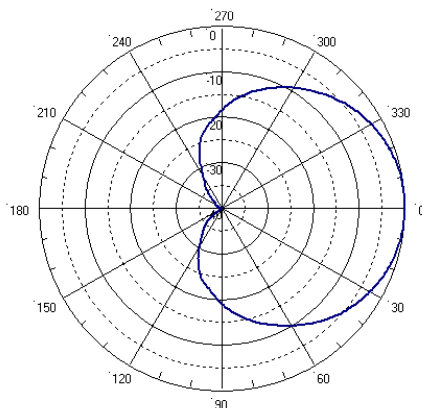

H&V Pattern

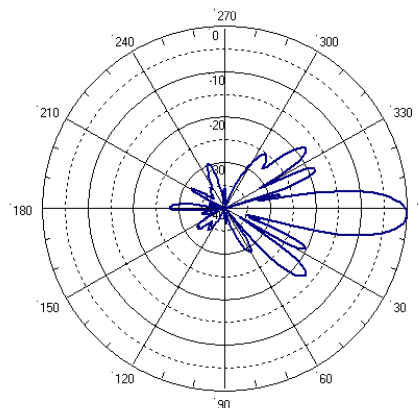

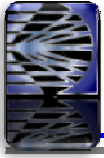

SINGLE-BAND PANEL ANTENNA

BAND 850

824 - 896

H64° V7.6°

Fixed Tilt 0°, 2°, 4°, 6°

AT41-683TX

ELECTRICAL SPECIFICATIONS

BAND 850

Antenna Model	AT41-683TX
Polarization	Vertical
Frequency (MHz)	824 - 896
Horizontal Beamwidth	64°
Vertical Beamwidth	7.6°
Gain (dBi)	17.1
Vertical Electrical Tilt	FIXED 0°, 2°, 4°, 6°
Upper Sidelobe Suppression for the 1 st lobe above main beam (dB)	18
Front-to-Back Ratio @ 180° ± 20° (dB)	> 30
VSWR	< 1.4 : 1
Maximum Power Per Input (W)	500
Intermodulation (dBc)	< - 150
Impedance (Ω)	50

MECHANICAL SPECIFICATIONS

Connectors	1 X 7/16 Female
Connector Position	Bottom
Survival Wind Speed km/h (mph)	200 (125)
Front Windload N @ 160 km/h (lbs @100 mph)	1270 (285)
Lateral Windload N @ 160 km/h (lbs @100 mph)	260 (60)
Radome Color	Grey, paintable
Humidity	100%
Antenna Weight kg (lbs)	22 (48)
Antenna Dimension mm (in) H X W X D	2530 X 310 X 110 (100 X 12 X 4)

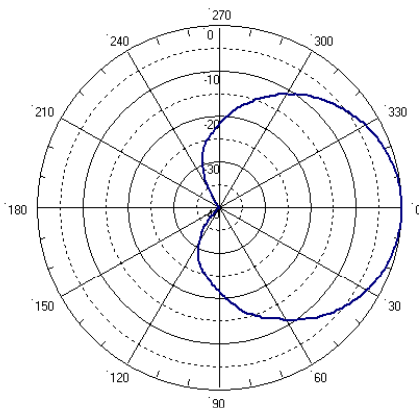

H&V Pattern

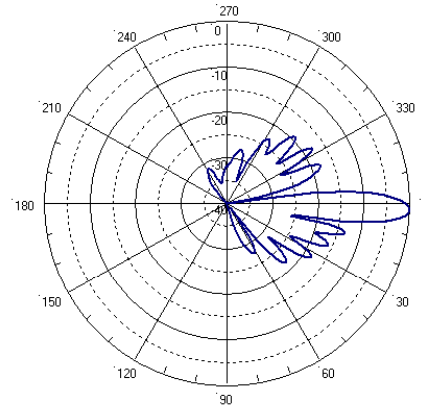

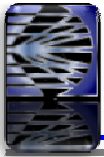

SINGLE-BAND PANEL ANTENNA

BAND 850

824 - 896

H88° V15.2°

Fixed Tilt 0°,2°,4°,6°

AT41-645TX

ELECTRICAL SPECIFICATIONS

BAND 850

Antenna Model	AT41-645TX
Polarization	Vertical
Frequency (MHz)	824 - 896
Horizontal Beamwidth	88°
Vertical Beamwidth	15.2°
Gain (dBi)	13.5
Vertical Electrical Tilt	FIXED 0°, 2°, 4°, 6°
Upper Sidelobe Suppression for the 1 st lobe above main beam (dB)	20
Front-to-Back Ratio @180° ± 20° (dB)	> 23
VSWR	< 1.4 : 1
Maximum Power Per Input (W)	500
Intermodulation (dBc)	< - 150
Impedance (Ω)	50

MECHANICAL SPECIFICATIONS

Connectors	1 X 7/16 Female
Connector Position	Bottom
Survival Wind Speed km/h (mph)	200 (125)
Front Windload N @ 160 km/h (lbs @100 mph)	670 (150)
Lateral Windload N @ 160 km/h (lbs @100 mph)	130 (30)
Radome Color	Grey, paintable
Humidity	100%
Antenna Weight kg (lbs)	12 (26)
Antenna Dimension mm (in) H X W X D	1340 X 310 X 110 (53 X 12 X 4)

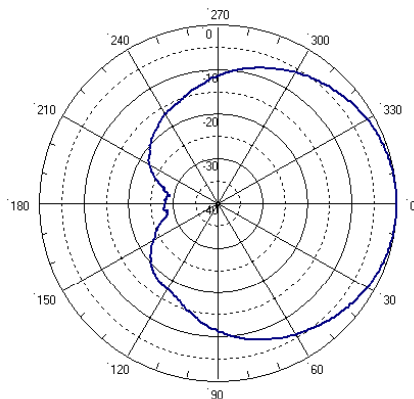

H&V Pattern

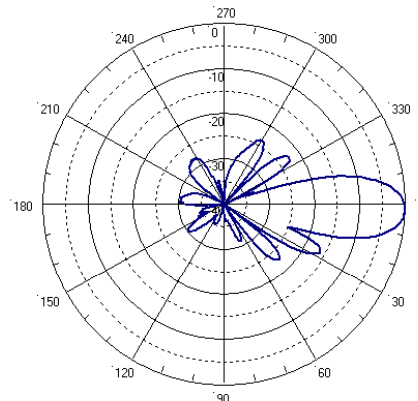

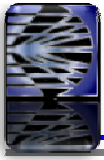

SINGLE-BAND PANEL ANTENNA

BAND 850

AT41-665TX

824 - 896

H88° V10.1°

Fixed Tilt 0°, 2°, 4°, 6°

ELECTRICAL SPECIFICATIONS

BAND 850

Antenna Model	AT41-665TX
Polarization	Vertical
Frequency (MHz)	824 - 896
Horizontal Beamwidth	88°
Vertical Beamwidth	10.1°
Gain (dBi)	15
Vertical Electrical Tilt	FIXED 0°, 2°, 4°, 6°
Upper Sidelobe Suppression for the 1 st lobe above main beam (dB)	23
Front-to-Back Ratio @180° ± 20° (dB)	> 25
VSWR	< 1.4 : 1
Maximum Power Per Input (W)	500
Intermodulation (dBc)	< - 150
Impedance (Ω)	50

MECHANICAL SPECIFICATIONS

Connectors	1 X 7/16 Female
Connector Position	Bottom
Survival Wind Speed km/h (mph)	200 (125)
Front Windload N @ 160 km/h (lbs @100 mph)	970 (220)
Lateral Windload N @ 160 km/h (lbs @100 mph)	200 (45)
Radome Color	Grey, paintable
Humidity	100%
Antenna Weight kg (lbs)	18 (39)
Antenna Dimension mm (in) H X W X D	1985 X 310 X 110 (78 X 12 X 4)

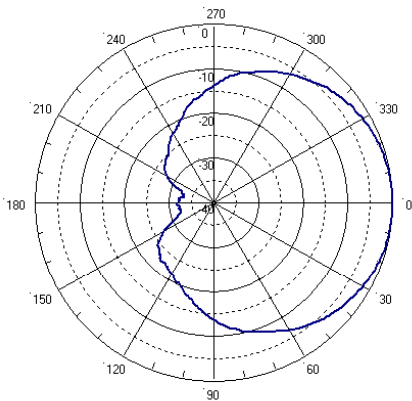

H&V Pattern

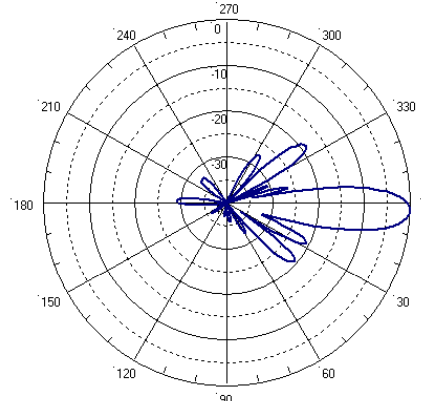

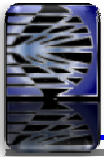

SINGLE-BAND PANEL ANTENNA

BAND 850

AT41-685TX

824 - 896

H88° V7.8°

Fixed Tilt 0°,2°,4°,6°

ELECTRICAL SPECIFICATIONS

BAND 850

Antenna Model	AT41-685TX
Polarization	Vertical
Frequency (MHz)	824 - 896
Horizontal Beamwidth	88°
Vertical Beamwidth	7.8°
Gain (dBi)	16
Vertical Electrical Tilt	FIXED 0°, 2°, 4°, 6°
Upper Sidelobe Suppression for the 1 st lobe above main beam (dB)	22
Front-to-Back Ratio /Cpol @ ± 20° (dB)	> 23
VSWR	< 1.4 : 1
Maximum Power Per Input (W)	500
Intermodulation (dBc)	< - 150
Impedance (Ω)	50



MECHANICAL SPECIFICATIONS

Connectors	1 X 7/16 Female
Connector Position	Bottom
Survival Wind Speed km/h (mph)	200 (125)
Front Windload N @ 160 km/h (lbs @100 mph)	1270 (285)
Lateral Windload N @ 160 km/h (lbs @100 mph)	260 (60)
Radome Color	Grey, paintable
Humidity	100%
Antenna Weight kg (lbs)	22 (48)
Antenna Dimension in (mm) H X W X D	2530 X 310 X 110 (100 X 12 X 4)

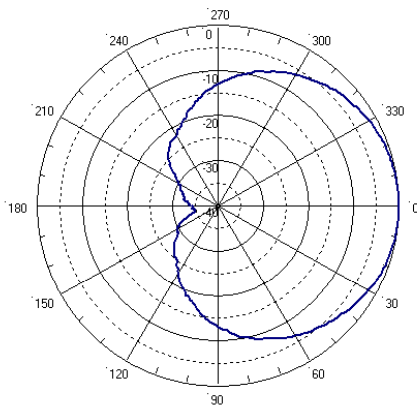

H&V Pattern

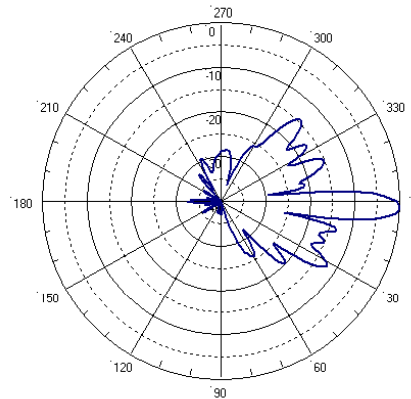

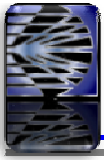

SINGLE-BAND PANEL ANTENNA

BAND 850

AT41-684TX

ELECTRICAL SPECIFICATIONS

BAND 850

Antenna Model	AT41-684TX
Polarization	± 45°
Frequency (MHz)	824 - 896
Horizontal Beamwidth	64°
Vertical Beamwidth	7.6°
Gain (dBi)	17.1
Vertical Electrical Tilt	FIXED 0°, 2°, 4°, 6°
Upper Sidelobe Suppression for the 1 st lobe above main beam (dB)	16
Front-to-Back Ratio @180° ± 20° (dB)	> 30
VSWR	< 1.4 : 1
Cross Polar Ratio @ ± 60° (dB) <i>Typically</i>	> 12
Isolation Between Ports	> 30
Maximum Power Per Input (W)	500
Intermodulation (dBc)	< - 150
Impedance (Ω)	50

824 - 896
H64° V7.6°
Fixed Tilt 0°, 2°, 4°, 6°



MECHANICAL SPECIFICATIONS

Connectors	2 X 7/16 Female
Connector Position	Bottom
Survival Wind Speed km/h (mph)	200 (125)
Front Windload N @ 160 km/h (lbs @100 mph)	1270 (285)
Lateral Windload N @ 160 km/h (lbs @100 mph)	260 (60)
Radome Color	Grey, paintable
Humidity	100%
Antenna Weight kg (lbs)	22 (48)
Antenna Dimension mm (in) H X W X D	2530 X 310 X 110 (100 X 12 X 4)

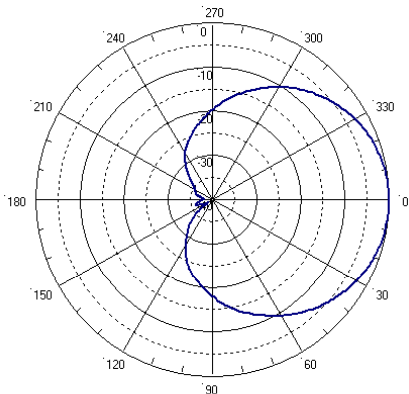

H&V Pattern

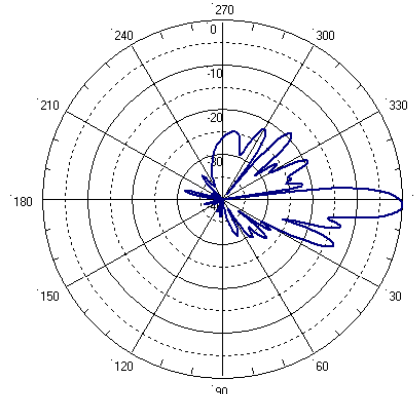



SINGLE-BAND PANEL ANTENNA

BAND 850

824 - 896

H64° V7.4°

Variable Tilt 0°-8°

AT41-684TV

ELECTRICAL SPECIFICATIONS

BAND 850

Antenna Model	AT41-684TV		
Polarization	± 45°		
Frequency (MHz)	824 - 896		
Horizontal Beamwidth	64°		
Vertical Beamwidth	7.4°		
Gain (dBi)	T0	T4	T8
	16.5	17	17
Vertical Electrical Tilt	VARIABLE 0°-8°		
Upper Sidelobe Suppression for the 1 st lobe above main beam (dB)	T0	T4	T8
	23	23	20
Front-to-Back Ratio @180° ± 20° (dB)	> 25		
VSWR	< 1.4 : 1		
Cross Polar Ratio @ ± 60° (dB) <i>Typically</i>	> 7		
Isolation Between Ports	> 30		
Maximum Power Per Input (W)	500		
Intermodulation (dBc)	< - 150		
Impedance (Ω)	50		



MECHANICAL SPECIFICATIONS

Connectors	2 X 7/16 Female	
Connector Position	Bottom	
Survival Wind Speed	km/h (mph)	200 (125)
Front Windload		
N @ 160 km/h	(lbs @100 mph)	1350 (303)
Lateral Windload		
N @ 160 km/h	(lbs @100 mph)	270 (61)
Radome Color	Grey, paintable	
Humidity	100%	
Antenna Weight	kg (lbs)	24 (53)
Antenna Dimension	mm (in) H X W X D	
	2530 X 325 X 115 (100 X 13 X 5)	

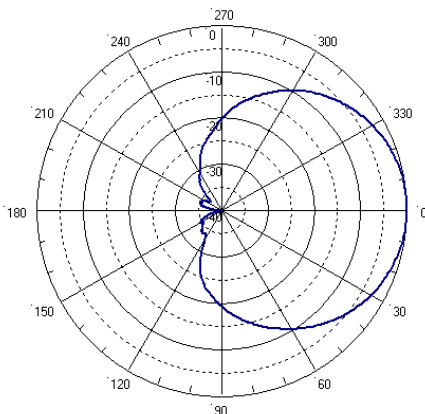

H&V Pattern

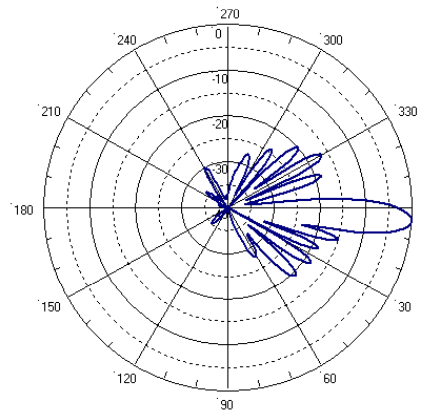

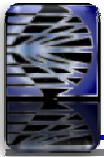

SINGLE-BAND PANEL ANTENNA

BAND 850

824 - 896

H64° V10.3°

Fixed Tilt 0°, 2°, 4°, 6°

AT41-664TX

ELECTRICAL SPECIFICATIONS

BAND 850

Antenna Model	AT41-664TX
Polarization	± 45°
Frequency (MHz)	824 - 896
Horizontal Beamwidth	64°
Vertical Beamwidth	10.3°
Gain (dBi)	16.2
Vertical Electrical Tilt	FIXED 0°, 2°, 4°, 6°
Upper Sidelobe Suppression for the 1 st lobe above main beam (dB)	22
Front-to-Back Ratio @180° ± 20° (dB)	> 30
VSWR	< 1.4 : 1
Cross Polar Ratio @ ± 60° (dB) <i>Typically</i>	> 10
Isolation Between Ports	> 30
Maximum Power Per Input (W)	500
Intermodulation (dBc)	< - 150
Impedance (Ω)	50



MECHANICAL SPECIFICATIONS

Connectors	2 X 7/16 Female
Connector Position	Bottom
Survival Wind Speed km/h (mph)	200 (125)
Front Windload N @ 160 km/h (lbs @100 mph)	970 (220)
Lateral Windload N @ 160 km/h (lbs @100 mph)	200 (45)
Radome Color	Grey, paintable
Humidity	100%
Antenna Weight kg (lbs)	18 (39)
Antenna Dimension mm (in) H X W X D	1985 X 310 X 110 (78 X 12 X 4)

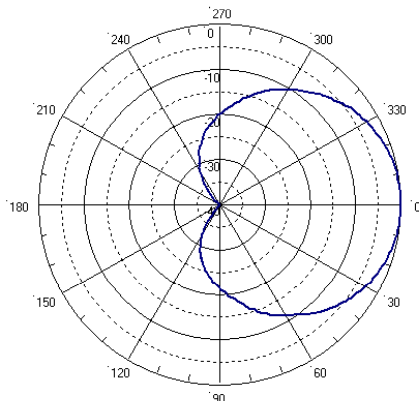

H&V Pattern

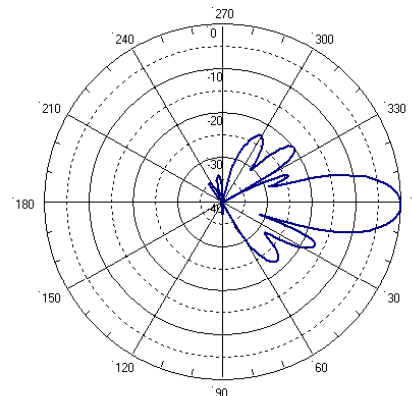

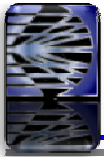

SINGLE-BAND PANEL ANTENNA

BAND 850

824 - 896

H64° V10.7°

Variable Tilt 0°-10°

AT41-664TV

ELECTRICAL SPECIFICATIONS

BAND 850

Antenna Model	AT41-664TV		
Polarization	± 45°		
Frequency (MHz)	824 - 896		
Horizontal Beamwidth	64°		
Vertical Beamwidth	10.7°		
Gain (dBi)	T0	T5	T10
	16	16	16
Vertical Electrical Tilt	VARIABLE 0°-10°		
Upper Sidelobe Suppression for the 1 st lobe above main beam (dB)	T0	T5	T10
	23	20	17
Front-to-Back Ratio @180° ± 20° (dB)	> 27		
VSWR	< 1.4 : 1		
Cross Polar Ratio @ ± 60° (dB) Typically	> 10		
Isolation Between Ports	> 30		
Maximum Power Per Input (W)	500		
Intermodulation (dBc)	< - 150		
Impedance (Ω)	50		



MECHANICAL SPECIFICATIONS

Connectors	2 X 7/16 Female	
Connector Position	Bottom	
Survival Wind Speed	km/h (mph)	200 (125)
Front Windload		
N @ 160 km/h	(lbs @100 mph)	1040 (234)
Lateral Windload		
N @ 160 km/h	(lbs @100 mph)	200 (45)
Radome Color	Grey, paintable	
Humidity	100%	
Antenna Weight	kg (lbs)	20 (44)
Antenna Dimension		
mm (in) H X W X D	1985 X 325 X 115 (78 X 13 X 5)	

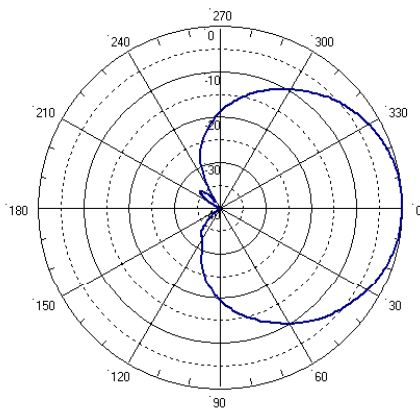

H&V Pattern

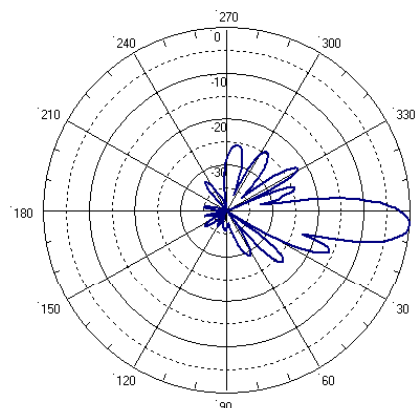

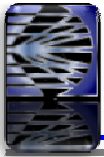

SINGLE-BAND PANEL ANTENNA

BAND 850

824 - 896

H64° V15°

Fixed Tilt 0°, 2°, 4°, 6°

AT41-644 TX

ELECTRICAL SPECIFICATIONS

BAND 850

Antenna Model	AT41-644TX
Polarization	± 45°
Frequency (MHz)	824 - 896
Horizontal Beamwidth	64°
Vertical Beamwidth	15°
Gain (dBi)	14.5
Vertical Electrical Tilt	FIXED 0°, 2°, 4°, 6°
Upper Sidelobe Suppression for the 1 st lobe above main beam (dB)	17
Front-to-Back Ratio @180° ± 20° (dB)	> 30
VSWR	< 1.4 : 1
Cross Polar Ratio @ ± 60° (dB) <i>Typically</i>	> 12
Isolation Between Ports	> 30
Maximum Power Per Input (W)	500
Intermodulation (dBc)	< - 150
Impedance (Ω)	50



MECHANICAL SPECIFICATIONS

Connectors	2 X 7/16 Female	
Connector Position	Bottom	
Survival Wind Speed	km/h (mph)	200 (125)
Front Windload	N @ 160 km/h	670 (150)
	(lbs @100 mph)	
Lateral Windload	N @ 160 km/h	130 (30)
	(lbs @100 mph)	
Radome Color	Grey, paintable	
Humidity	100%	
Antenna Weight	kg (lbs)	13 (28)
Antenna Dimension	mm (in) H X W X D	1340 X 310 X 110 (53 X 12 X 4)

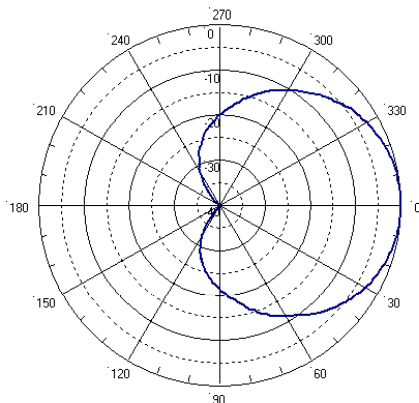

H&V Pattern

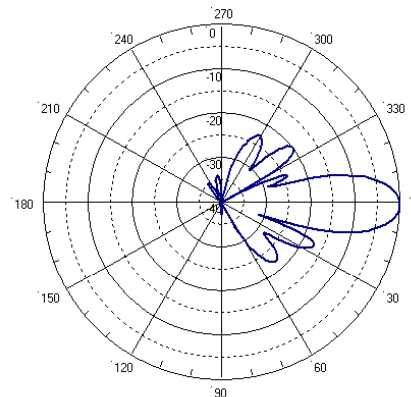

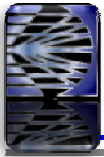

SINGLE-BAND PANEL ANTENNA

BAND 850

824 - 896

H64° V14.3°

Variable Tilt 0°-10°

AT41-644TV

ELECTRICAL SPECIFICATIONS

BAND 850

Antenna Model	AT41-644TV		
Polarization	± 45°		
Frequency (MHz)	824 - 896		
Horizontal Beamwidth	64°		
Vertical Beamwidth	14.3°		
Gain (dBi)	T0 15	T5 15	T10 15
Vertical Electrical Tilt	VARIABLE 0°-10°		
Upper Sidelobe Suppression for the 1 st lobe above main beam (dB)	T0 19	T5 17	T10 15
Front-to-Back Ratio @ 180 ± 20° (dB)	> 25		
VSWR	< 1.4 : 1		
Cross Polar Ratio @ ± 60° (dB) <i>Typically</i>	> 10		
Isolation Between Ports	> 30		
Maximum Power Per Input (W)	500		
Intermodulation (dBc)	< - 150		
Impedance (Ω)	50		



MECHANICAL SPECIFICATIONS

Connectors	2 X 7/16 Female	
Connector Position	Bottom	
Survival Wind Speed km/h (mph)	200 (125)	
Front Windload N @ 160 km/h (lbs @ 100 mph)	690 (155)	
Lateral Windload N @ 160 km/h (lbs @ 100 mph)	130 (29)	
Radome Color	Grey, paintable	
Humidity	100%	
Antenna Weight kg (lbs)	15 (33)	
Antenna Dimension mm (in) H X W X D	1340 X 325 X 110 (53 X 13 X 4)	

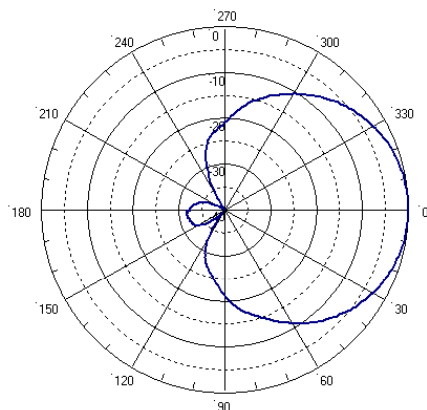

H&V Pattern

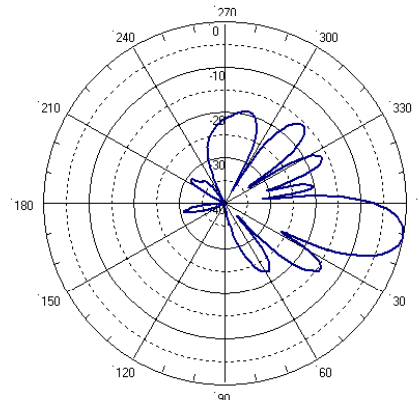

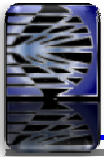

SINGLE-BAND PANEL ANTENNA

BAND 850

824 - 896

H88° V7.8°

Fixed Tilt 0°, 2°, 4°, 6°

AT41-686TX

ELECTRICAL SPECIFICATIONS

BAND 850

Antenna Model	AT41-686TX
Polarization	± 45°
Frequency (MHz)	824 - 896
Horizontal Beamwidth	88°
Vertical Beamwidth	7.8°
Gain (dBi)	16
Vertical Electrical Tilt	FIXED 0°, 2°, 4°, 6°
Upper Sidelobe Suppression for the 1 st lobe above main beam (dB)	19
Front-to-Back Ratio @ 180° ± 20° (dB)	> 25
VSWR	< 1.4 : 1
Cross Polar Ratio @ ± 60° (dB) <i>Typically</i>	> 10
Isolation Between Ports	> 30
Maximum Power Per Input (W)	500
Intermodulation (dBc)	< - 150
Impedance (Ω)	50



MECHANICAL SPECIFICATIONS

Connectors	2 X 7/16 Female
Connector Position	Bottom
Survival Wind Speed km/h (mph)	200 (125)
Front Windload N @ 160 km/h (lbs @100 mph)	1270 (285)
Lateral Windload N @ 160 km/h (lbs @100 mph)	260 (60)
Radome Color	Grey, paintable
Humidity	100%
Antenna Weight kg (lbs)	22 (48)
Antenna Dimension mm (in) H X W X D	2530 X 310 X 110 (100 X 12 X 4)

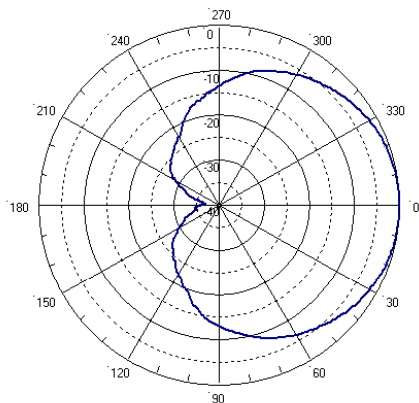

H&V Pattern

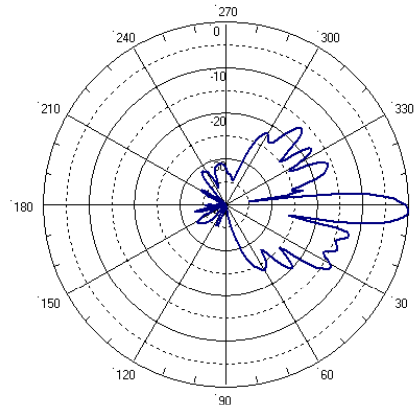

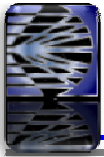

SINGLE-BAND PANEL ANTENNA

BAND 850

824 - 896

H85° V7.6°

Variable Tilt 0°-8°

AT41-686TV

ELECTRICAL SPECIFICATIONS

BAND 850

Antenna Model	AT41-686TV		
Polarization	± 45°		
Frequency (MHz)	824 - 896		
Horizontal Beamwidth	85°		
Vertical Beamwidth	7.6°		
Gain (dBi)	T0	T4	T8
	15	15.5	15.5
Vertical Electrical Tilt	VARIABLE 0°-8°		
Upper Sidelobe Suppression for the 1 st lobe above main beam (dB)	T0	T4	T8
	17	17	15
Front-to-Back Ratio @180° ± 20° (dB)	> 23		
VSWR	< 1.4 : 1		
Cross Polar Ratio @ ± 60° (dB) <i>Typically</i>	> 12		
Isolation Between Ports	> 30		
Maximum Power Per Input (W)	500		
Intermodulation (dBc)	< - 150		
Impedance (Ω)	50		



MECHANICAL SPECIFICATIONS

Connectors	2 X 7/16 Female	
Connector Position	Bottom	
Survival Wind Speed	km/h (mph)	200 (125)
Front Windload	1350 (303)	
N @ 160 km/h	(lbs @100 mph)	
Lateral Windload	270 (61)	
N @ 160 km/h	(lbs @100 mph)	
Radome Color	Grey, paintable	
Humidity	100%	
Antenna Weight	kg (lbs)	24 (53)
Antenna Dimension	2530 X 325 X 115 (100 X 13 X 5)	
mm (in) H X W X D		

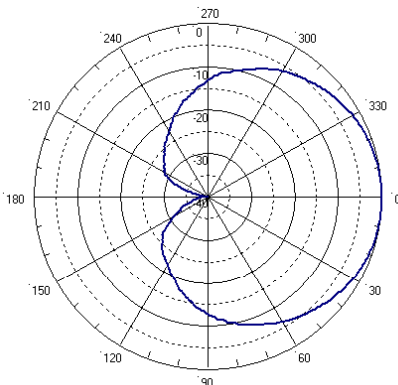

H&V Pattern

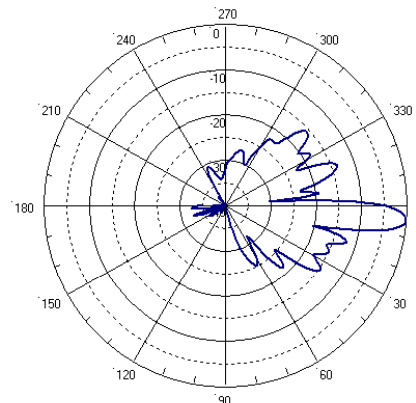



SINGLE-BAND PANEL ANTENNA

BAND 850

824 - 896

H88° V10.3°

Fixed Tilt 0°, 2°, 4°, 6°

AT41-666TX

ELECTRICAL SPECIFICATIONS

BAND 850

Antenna Model	AT41-666TX
Polarization	± 45°
Frequency (MHz)	824 - 896
Horizontal Beamwidth	88°
Vertical Beamwidth	10.3°
Gain (dBi)	15
Vertical Electrical Tilt	FIXED 0°, 2°, 4°, 6°
Upper Sidelobe Suppression for the 1 st lobe above main beam (dB)	20
Front-to-Back Ratio @180° ± 20° (dB)	> 25
VSWR	< 1.4 : 1
Cross Polar Ratio @ ± 60° (dB) <i>Typically</i>	> 10
Isolation Between Ports	> 30
Maximum Power Per Input (W)	500
Intermodulation (dBc)	< - 150
Impedance (Ω)	50



MECHANICAL SPECIFICATIONS

Connectors	2 X 7/16 Female
Connector Position	Bottom
Survival Wind Speed km/h (mph)	200 (125)
Front Windload N @ 160 km/h (lbs @100 mph)	970 (220)
Lateral Windload N @ 160 km/h (lbs @100 mph)	200 (45)
Radome Color	Grey, paintable
Humidity	100%
Antenna Weight kg (lbs)	18 (39)
Antenna Dimension mm (in) H X W X D	1985 X 310 X 110 (78 X 12 X 4)

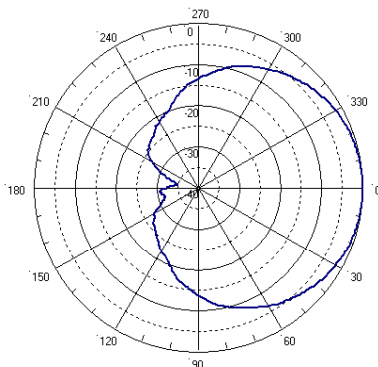

H&V Pattern

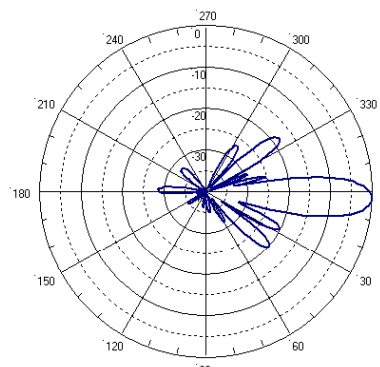

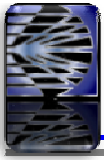

SINGLE-BAND PANEL ANTENNA

BAND 850

824 - 896

H85° V10.8°

Variable Tilt 0°-10°

AT41-666TV

ELECTRICAL SPECIFICATIONS

BAND 850

Antenna Model	AT41-666TV		
Polarization	± 45°		
Frequency (MHz)	824 - 896		
Horizontal Beamwidth	85°		
Vertical Beamwidth	10.8°		
Gain (dBi)	T0	T5	T10
	14.5	14.5	14.5
Vertical Electrical Tilt	VARIABLE 0°-10°		
Upper Sidelobe Suppression for the 1 st lobe above main beam (dB)	T0	T5	T10
	18	17	15
Front-to-Back Ratio @180° ± 20° (dB)	> 25		
VSWR	< 1.4 : 1		
Cross Polar Ratio @ ± 60° (dB) <i>Typically</i>	> 12		
Isolation Between Ports	> 30		
Maximum Power Per Input (W)	500		
Intermodulation (dBc)	< - 150		
Impedance (Ω)	50		



MECHANICAL SPECIFICATIONS

Connectors	2 X 7/16 Female	
Connector Position	Bottom	
Survival Wind Speed	km/h (mph)	200 (125)
Front Windload		1040 (234)
N @ 160 km/h	(lbs @100 mph)	
Lateral Windload		200 (45)
N @ 160 km/h	(lbs @100 mph)	
Radome Color	Grey, paintable	
Humidity	100%	
Antenna Weight	kg (lbs)	20 (44)
Antenna Dimension	1985 X 325 X 115 (78 X 13 X 5)	
mm (in)	H X W X D	

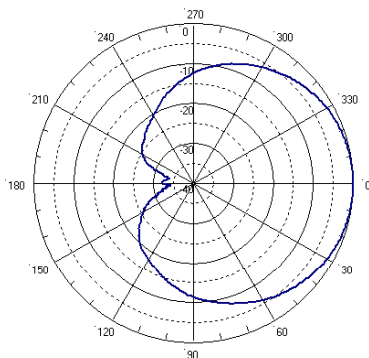

H&V Pattern

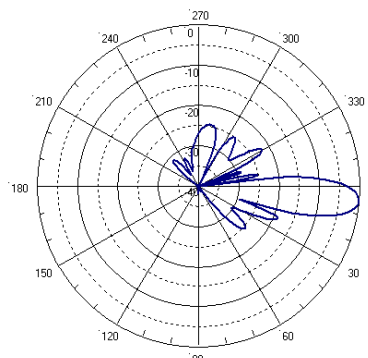

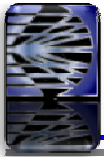

SINGLE-BAND PANEL ANTENNA

BAND 850

824 - 896

H88° V15.3°

Fixed Tilt 0°, 2°, 4°, 6°

AT41-646TX

ELECTRICAL SPECIFICATIONS

BAND 850

Antenna Model	AT41-646TX
Polarization	± 45°
Frequency (MHz)	824 - 896
Horizontal Beamwidth	88°
Vertical Beamwidth	15.3°
Gain (dBi)	13.5
Vertical Electrical Tilt	FIXED 0°, 2°, 4°, 6°
Upper Sidelobe Suppression for the 1 st lobe above main beam (dB)	18
Front-to-Back Ratio /Cpol @ ± 20° (dB)	> 23
VSWR	< 1.4 : 1
Cross Polar Ratio @ ± 60° (dB) <i>Typically</i>	> 12
Isolation Between Ports	> 30
Maximum Power Per Input (W)	500
Intermodulation (dBc)	< - 150
Impedance (Ω)	50



MECHANICAL SPECIFICATIONS

Connectors	2 X 7/16 Female
Connector Position	Bottom
Survival Wind Speed km/h (mph)	200 (125)
Front Windload N @ 160 km/h (lbs @100 mph)	670 (150)
Lateral Windload N @ 160 km/h (lbs @100 mph)	130 (30)
Radome Color	Grey, paintable
Humidity	100%
Antenna Weight kg (lbs)	13 (28)
Antenna Dimension mm (in) H X W X D	1340 X 310 X 110 (53 X 12 X 4)

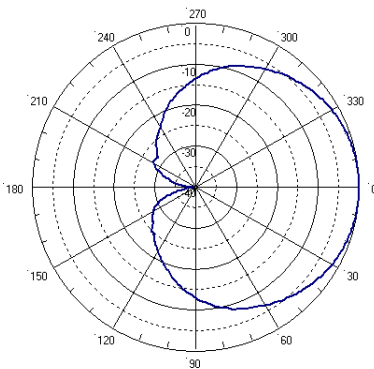

H&V Pattern

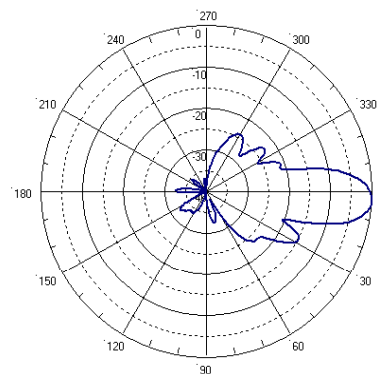

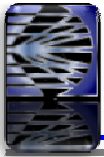

SINGLE-BAND PANEL ANTENNA

BAND 850

824 - 896

H85° V14.5°

Variable Tilt 0°-10°

AT41-646TV

ELECTRICAL SPECIFICATIONS

BAND 850

Antenna Model	AT41-646TV		
Polarization	± 45°		
Frequency (MHz)	824 - 896		
Horizontal Beamwidth	85°		
Vertical Beamwidth	14.5°		
Gain (dBi)	T0	T5	T10
	13.5	13.5	13.5
Vertical Electrical Tilt	VARIABLE 0°-10°		
Upper Sidelobe Suppression for the 1 st lobe above main beam (dB)	T0	T5	T10
	17	15	13
Front-to-Back Ratio @180° ± 20° (dB)	> 23		
VSWR	< 1.4 : 1		
Cross Polar Ratio @ ± 60° (dB) <i>Typically</i>	> 12		
Isolation Between Ports	> 30		
Maximum Power Per Input (W)	500		
Intermodulation (dBc)	< - 150		
Impedance (Ω)	50		



MECHANICAL SPECIFICATIONS

Connectors	2 X 7/16 Female	
Connector Position	Bottom	
Survival Wind Speed	km/h (mph)	200 (125)
Front Windload		
N @ 160 km/h	(lbs @100 mph)	690 (155)
Lateral Windload		
N @ 160 km/h	(lbs @100 mph)	130 (30)
Radome Color	Grey, paintable	
Humidity	100%	
Antenna Weight	kg (lbs)	15 (33)
Antenna Dimension		
mm (in) H X W X D	1340 X 325 X 115 (53 X 13 X 5)	

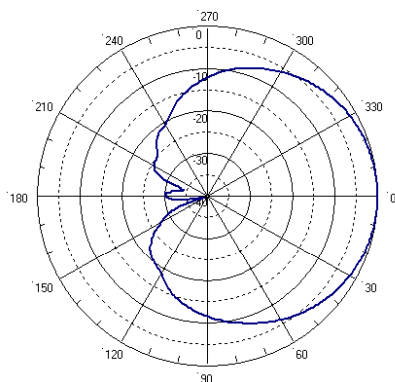

H&V Pattern

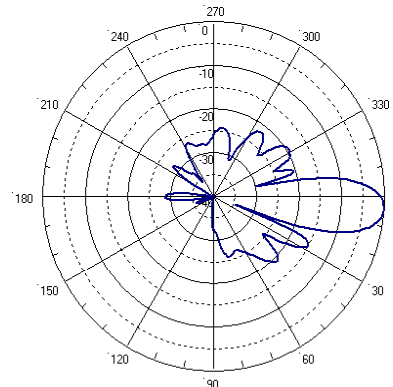

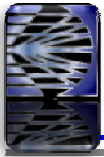

SINGLE-BAND PANEL ANTENNA

BAND 850

ATR41-XXX* with attached RET

824 - 896

H64° V7.4°

Variable Tilt 0°-8°

ELECTRICAL SPECIFICATIONS

BAND 850

Antenna Model	ATR41-XXX
Polarization	± 45°
Frequency (MHz)	824 - 896
Horizontal Beamwidth	64°
Vertical Beamwidth	7.4°
Gain (dBi)	17
Vertical Electrical Tilt	VARIABLE 0°-8°
Upper Sidelobe Suppression for the 1 st lobe above main beam (dB)	17
Front-to-Back Ratio @ 180° ± 20° (dB)	> 30
VSWR	< 1.4 : 1
Cross Polar Ratio @ ± 60° (dB)	> 10
Isolation Between Ports	> 30
Maximum Power Per Input (W)	500
Intermodulation (dBc)	< - 150
Impedance (Ω)	50

MECHANICAL SPECIFICATIONS

Connectors	2 X 7/16 Female	
Connector Position	Bottom	
Survival Wind Speed	km/h (mph)	200 (125)
Front Windload		
N @ 160 km/h	(lbs @100 mph)	1270 (285)
Lateral Windload		
N @ 160 km/h	(lbs @100 mph)	260 (60)
Radome Color		Grey, paintable
Temperature Range	°C (F)	-55° to +60° (-67° to +140°)
Humidity		100%
Antenna Weight	kg (lbs)	24 (53)
Antenna Dimension	mm (in) H X W X D	2530 X 310 X 110 (100 X 12 X 4)



*ATR41XXX version with attached RET

available for the references:

664TV, 684TV, 686TV



SINGLE-BAND PANEL ANTENNA

BAND 900

SINGLE-BAND PANEL ANTENNA								
BAND 900								
Frequency	HBW	VBW	Gain (dbi)	Polarization	Tilt	Height mm (in)	Model	Page
870 - 960	65°	15°	15.1	Vertical	Fixed 0°, 2°, 4°, 6°	1340 (52)	AT42-643TX	40
870 - 960	65°	10°	16.6	Vertical	Fixed 0°, 2°, 4°, 6°	1985 (78)	AT42-663TX	41
870 - 960	65°	6°	17.5	Vertical	Fixed 0°, 2°, 4°, 6°	2530 (100)	AT42-683TX	42
870 - 960	90°	15°	14	Vertical	Fixed 0°, 2°, 4°, 6°	1340 (52)	AT42-645TX	43
870 - 960	90°	10°	15.5	Vertical	Fixed 0°, 2°, 4°, 6°	1985 (78)	AT42-665TX	44
870 - 960	90°	6°	16.2	Vertical	Fixed 0°, 2°, 4°, 6°	2530 (100)	AT42-685TX	45
870 - 960	65°	15°	15.1	± 45°	Fixed 0°, 2°, 4°, 6°	1340 (52)	AT42-644TX	46
870 - 960	65°	15°	15.1	± 45°	Variable 0°- 10°	1340 (52)	AT42-644TV	47
870 - 960	65°	10°	16.6	± 45°	Variable 0°- 10°	1985 (78)	AT42-664TV	48
870 - 960	65°	10°	16.6	± 45°	Fixed 0°, 2°, 4°, 6°	1985 (78)	AT42-664TX	49
870 - 960	65°	6°	17.5	± 45°	Fixed 0°, 2°, 4°, 6°	2530 (100)	AT42-684TX	50
870 - 960	65°	6°	17.5	± 45°	Variable 0°- 8°	2530 (100)	AT42-684TV	51
870 - 960	90°	15°	14	± 45°	Fixed 0°, 2°, 4°, 6°	1340 (52)	AT42-646TX	52
870 - 960	90°	15°	14	± 45°	Variable 0°- 10°	1340 (52)	AT42-646TV	53
870 - 960	90°	10°	15.5	± 45°	Fixed 0°, 2°, 4°, 6°	1985 (78)	AT42-666TX	54
870 - 960	90°	10°	15.5	± 45°	Variable 0°- 10°	1985 (78)	AT42-666TV	55
870 - 960	90°	6°	16.2	± 45°	Fixed 0°, 2°, 4°, 6°	2530 (100)	AT42-686TX	56
870 - 960	90°	6°	16.2	± 45°	Variable 0°- 8°	2530 (100)	AT42-686TV	57

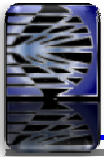

SINGLE-BAND PANEL ANTENNA

BAND 900

AT42-643TX

870 - 960

H64° V14.4°

Fixed Tilt 0°,2°,4°,6°

ELECTRICAL SPECIFICATIONS

BAND 900

Antenna Model	AT42-643TX
Polarization	Vertical
Frequency (MHz)	870 - 960
Horizontal Beamwidth	64°
Vertical Beamwidth	14.4°
Gain (dBi)	15.1
Vertical Electrical Tilt	FIXED 0°,2°,4°,6°
Upper Sidelobe Suppression for the 1 st lobe above main beam (dB)	20
Front-to-Back Ratio @ 180° ± 20° (dB)	> 27
VSWR	< 1.4 : 1
Maximum Power Per Input (W)	500
Intermodulation (dBc)	< - 150
Impedance (Ω)	50



MECHANICAL SPECIFICATIONS

Connectors	1 X 7/16 Female
Connector Position	Bottom
Survival Wind Speed km/h (mph)	200 (125)
Front Windload N @ 160 km/h (lbs @100 mph)	670 (150)
Lateral Windload N @ 160 km/h (lbs @100 mph)	130 (30)
Radome Color	Grey, paintable
Humidity	100%
Antenna Weight kg (lbs)	13 (28)
Antenna Dimension mm (in) H X W X D	1340 X 310 X 110 (52 X 12 X 4)

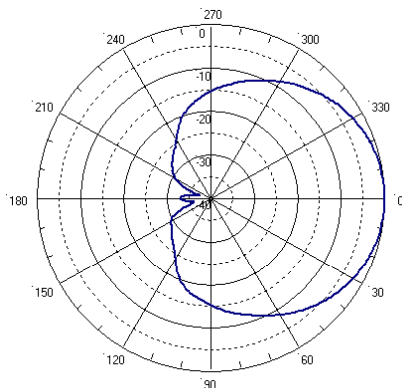

H&V Pattern

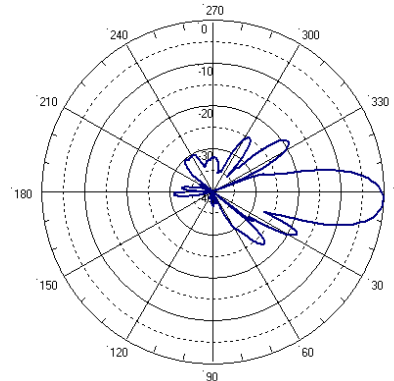

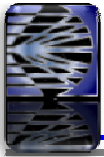

SINGLE-BAND PANEL ANTENNA

BAND 900

AT42-663TX

870 - 960

H64° V10.3°

Fixed Tilt 0°,2°,4°,6°

ELECTRICAL SPECIFICATIONS

BAND 900

Antenna Model	AT42-663TX
Polarization	Vertical
Frequency (MHz)	870 - 960
Horizontal Beamwidth	64°
Vertical Beamwidth	10.3°
Gain (dBi)	16.6
Vertical Electrical Tilt	FIXED 0°,2°,4°,6°
Upper Sidelobe Suppression for the 1 st lobe above main beam (dB)	18
Front-to-Back Ratio @ 180° ± 20° (dB)	> 30
VSWR	< 1.4 : 1
Maximum Power Per Input (W)	500
Intermodulation (dBc)	< - 150
Impedance (Ω)	50



MECHANICAL SPECIFICATIONS

Connectors	1 X 7/16 Female
Connector Position	Bottom
Survival Wind Speed km/h (mph)	200 (125)
Front Windload N @ 160 km/h (lbs @100 mph)	970 (220)
Lateral Windload N @ 160 km/h (lbs @100 mph)	200 (45)
Radome Color	Grey, paintable
Humidity	100%
Antenna Weight kg (lbs)	18 (40)
Antenna Dimension mm (in) H X W X D	1985 X 310 X 110 (78 X 12 X 4)

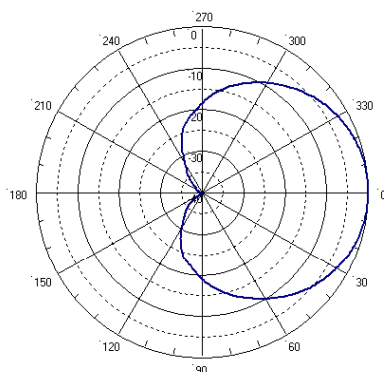

H&V Pattern

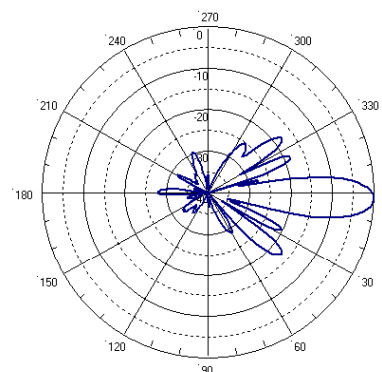

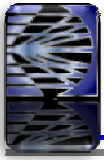

SINGLE-BAND PANEL ANTENNA

BAND 900

AT42-683TX

870 - 960

H64° V7.1°

Fixed Tilt 0°,2°,4°,6°

ELECTRICAL SPECIFICATIONS

BAND 900

Antenna Model	AT42-683TX
Polarization	Vertical
Frequency (MHz)	870 - 960
Horizontal Beamwidth	64°
Vertical Beamwidth	7.1°
Gain (dBi)	17.5
Vertical Electrical Tilt	FIXED 0°,2°,4°,6°
Upper Sidelobe Suppression for the 1 st lobe above main beam (dB)	18
Front-to-Back Ratio @ 180° ± 20° (dB)	> 30
VSWR	< 1.4 : 1
Maximum Power Per Input (W)	500
Intermodulation (dBC)	< - 150
Impedance (Ω)	50

MECHANICAL SPECIFICATIONS

Connectors	1 X 7/16 Female
Connector Position	Bottom
Survival Wind Speed km/h (mph)	200 (125)
Front Windload N @ 160 km/h (lbs @100 mph)	1270 (285)
Lateral Windload N @ 160 km/h (lbs @100 mph)	260 (60)
Radome Color	Grey, paintable
Humidity	100%
Antenna Weight kg (lbs)	22 (48)
Antenna Dimension mm (in) H X W X D	2530 X 310 X 110 (100 X 12 X 4)

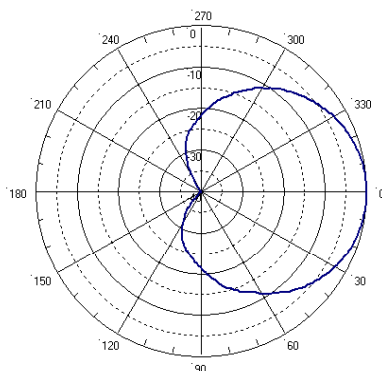

H&V Pattern

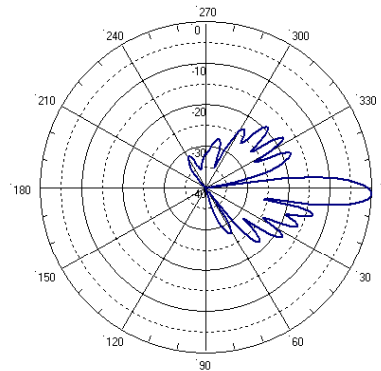

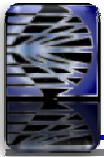

SINGLE-BAND PANEL ANTENNA

BAND 900

AT42-645TX

870 - 960

H88° V14.5°

Fixed Tilt 0°,2°,4°,6°

ELECTRICAL SPECIFICATIONS

BAND 900

Antenna Model	AT42-645TX
Polarization	Vertical
Frequency (MHz)	870 - 960
Horizontal Beamwidth	88°
Vertical Beamwidth	14.5°
Gain (dBi)	14
Vertical Electrical Tilt	FIXED 0°,2°,4°,6°
Upper Sidelobe Suppression for the 1 st lobe above main beam (dB)	20
Front-to-Back Ratio @ 180° ± 20° (dB)	> 23
VSWR	< 1.4 : 1
Maximum Power Per Input (W)	500
Intermodulation (dBc)	< - 150
Impedance (Ω)	50



MECHANICAL SPECIFICATIONS

Connectors	1 X 7/16 Female
Connector Position	Bottom
Survival Wind Speed km/h (mph)	200 (125)
Front Windload N @ 160 km/h (lbs @100 mph)	670 (150)
Lateral Windload N @ 160 km/h (lbs @100 mph)	130 (30)
Radome Color	Grey, paintable
Humidity	100%
Antenna Weight kg (lbs)	13 (28)
Antenna Dimension mm (in) H X W X D	1340 X 310 X 110 (52 X 12 X 4)

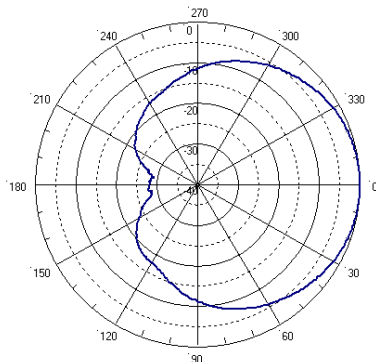

H&V Pattern

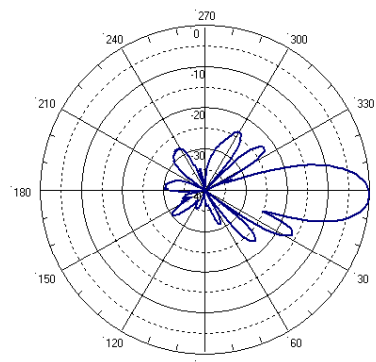

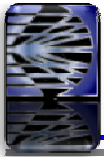

SINGLE-BAND PANEL ANTENNA

BAND 900

870 - 960

H88° V10.2°

Fixed Tilt 0°,2°,4°,6°

AT42-665TX

ELECTRICAL SPECIFICATIONS

BAND 900

Antenna Model	AT42-665TX
Polarization	Vertical
Frequency (MHz)	870 - 960
Horizontal Beamwidth	88°
Vertical Beamwidth	10.2°
Gain (dBi)	15.5
Vertical Electrical Tilt	FIXED 0°,2°,4°,6°
Upper Sidelobe Suppression for the 1 st lobe above main beam (dB)	17
Front-to-Back Ratio @ 180° ± 20° (dB)	> 25
VSWR	< 1.4 : 1
Maximum Power Per Input (W)	500
Intermodulation (dBc)	< -150
Impedance (Ω)	50

MECHANICAL SPECIFICATIONS

Connectors	1 X 7/16 Female
Connector Position	Bottom
Survival Wind Speed km/h (mph)	200 (125)
Front Windload N @ 160 km/h (lbs @100 mph)	970 (220)
Lateral Windload N @ 160 km/h (lbs @100 mph)	200 (45)
Radome Color	Grey, paintable
Humidity	100%
Antenna Weight kg (lbs)	18 (39)
Antenna Dimension mm (in) H X W X D	1985 X 310 X 110 (78 X 12 X 4)

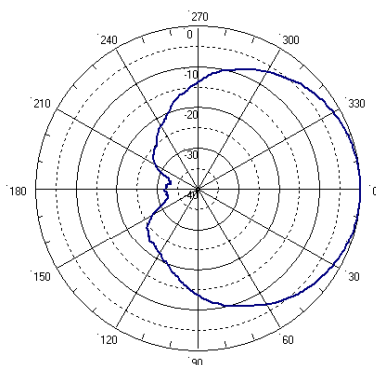

H&V Pattern

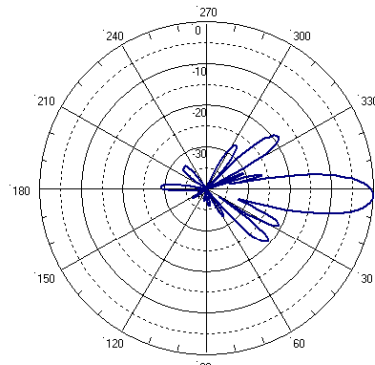

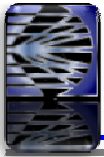

SINGLE-BAND PANEL ANTENNA

BAND 900

AT42-685TX

870 - 960

H88° V7.3°

Fixed Tilt 0°, 2°, 4°, 6°

ELECTRICAL SPECIFICATIONS

BAND 900

Antenna Model	AT42-685TX
Polarization	Vertical
Frequency (MHz)	870 - 960
Horizontal Beamwidth	88°
Vertical Beamwidth	7.3°
Gain (dBi)	16.2
Vertical Electrical Tilt	FIXED 0°, 2°, 4°, 6°
Upper Sidelobe Suppression for the 1 st lobe above main beam (dB)	22
Front-to-Back Ratio @ 180° ± 20° (dB)	> 22
VSWR	< 1.4 : 1
Maximum Power Per Input (W)	500
Intermodulation (dBc)	< -150
Impedance (Ω)	50



MECHANICAL SPECIFICATIONS

Connectors	1 X 7/16 Female
Connector Position	Bottom
Survival Wind Speed km/h (mph)	200 (125)
Front Windload N @ 160 km/h (lbs @100 mph)	1270 (285)
Lateral Windload N @ 160 km/h (lbs @100 mph)	260 (60)
Radome Color	Grey, paintable
Humidity	100%
Antenna Weight kg (lbs)	22 (48)
Antenna Dimension mm (in) H X W X D	2530 X 310 X 110 (100 X 12 X 4)

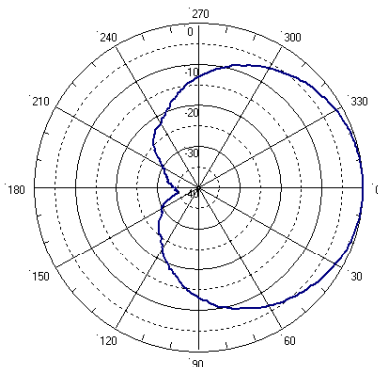

H&V Pattern

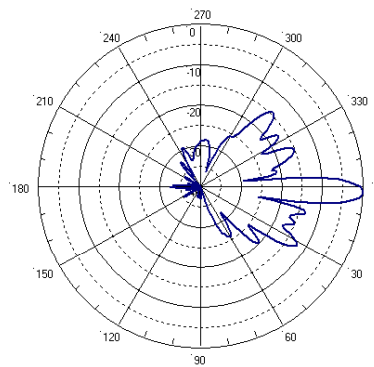

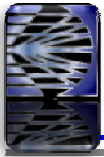

SINGLE-BAND PANEL ANTENNA

BAND 900

870 - 960

H64° V14.3°

Fixed Tilt 0°, 2°, 4°, 6°

AT42-644TX

ELECTRICAL SPECIFICATIONS

BAND 900

Antenna Model	AT42-644TX
Polarization	± 45°
Frequency (MHz)	870 - 960
Horizontal Beamwidth	64°
Vertical Beamwidth	14.3°
Gain (dBi)	15.1
Vertical Electrical Tilt	FIXED 0°, 2°, 4°, 6°
Upper Sidelobe Suppression for the 1 st lobe above main beam (dB)	20
Front-to-Back Ratio @ 180° ± 20° (dB)	> 30
VSWR	< 1.4 : 1
Cross Polar Ratio @ ± 60° (dB) <i>Typically</i>	> 12
Isolation Between Ports	> 30
Maximum Power Per Input (W)	500
Intermodulation (dBc)	< - 150
Impedance (Ω)	50



MECHANICAL SPECIFICATIONS

Connectors	2 X 7/16 Female
Connector Position	Bottom
Survival Wind Speed km/h (mph)	200 (125)
Front Windload N @ 160 km/h (lbs @100 mph)	670 (150)
Lateral Windload N @ 160 km/h (lbs @100 mph)	130 (30)
Radome Color	Grey, paintable
Humidity	100%
Antenna Weight kg (lbs)	13 (28)
Antenna Dimension mm (in) H X W X D	1340 X 310 X 110 (52 X 12 X 4)

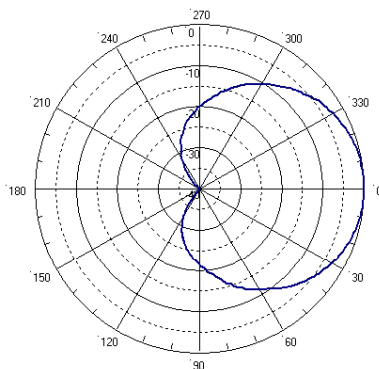

H&V Pattern

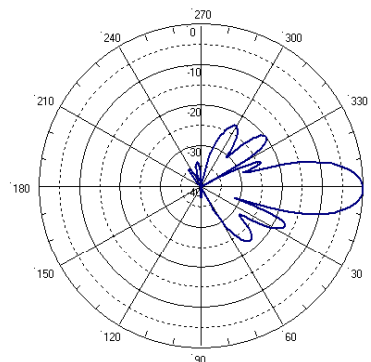



SINGLE-BAND PANEL ANTENNA

BAND 900

870 - 960

H64° V14.3°

Variable Tilt 0°-10°

AT42-644TV

ELECTRICAL SPECIFICATIONS

BAND 900

Antenna Model	AT42-644TV
Polarization	± 45°
Frequency (MHz)	870 - 960
Horizontal Beamwidth	64°
Vertical Beamwidth	14.3°
Gain (dBi)	15.1
Vertical Electrical Tilt	VARIABLE 0°-10°
Upper Sidelobe Suppression for the 1 st lobe above main beam (dB)	17
Front-to-Back Ratio @ 180° ± 20° (dB)	> 30
VSWR	< 1,4 : 1
Cross Polar Ratio @ ± 60° (dB) <i>Typically</i>	> 10
Isolation Between Ports	> 30
Maximum Power Per Input (W)	500
Intermodulation (dBc)	< - 150
Impedance (Ω)	50

MECHANICAL SPECIFICATIONS

Connectors	2 X 7/16 Female
Connector Position	Bottom
Survival Wind Speed km/h (mph)	200 (125)
Front Windload (N)	670 (150)
Lateral Windload N @ 160 km/h (lbs @100 mph)	130 (30)
Radome Color	Grey, paintable
Humidity	100%
Antenna Weight kg (lbs)	15 (33)
Antenna Dimension mm (in) H X W X D	1340 X 310 X 110 (52 X 12 X 4)

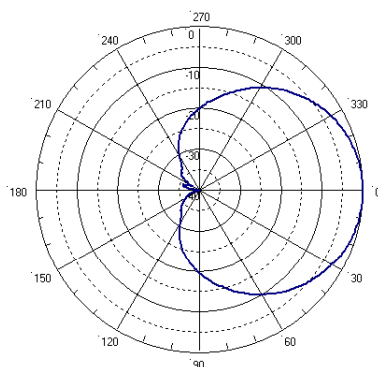

H&V Pattern

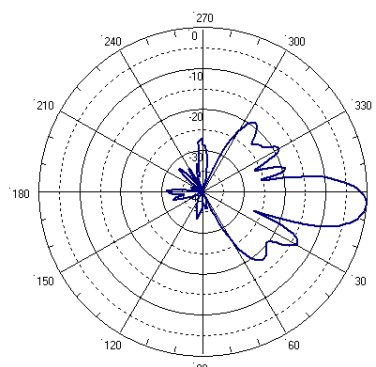



SINGLE-BAND PANEL ANTENNA

BAND 900

AT42-664TV

870 - 960

H64° V10.4°

Variable Tilt 0°-10°

ELECTRICAL SPECIFICATIONS

BAND 900

Antenna Model	AT42-664TV
Polarization	± 45°
Frequency (MHz)	870 - 960
Horizontal Beamwidth	64°
Vertical Beamwidth	10.4°
Gain (dBi)	16.6
Vertical Electrical Tilt	VARIABLE 0°-10°
Upper Sidelobe Suppression for the 1 st lobe above main beam (dB)	17
Front-to-Back Ratio @ 180° ± 20° (dB)	> 30
VSWR	< 1.4 : 1
Cross Polar Ratio @ ± 60° (dB) <i>Typically</i>	> 10
Isolation Between Ports	> 30
Maximum Power Per Input (W)	500
Intermodulation (dBc)	< - 150
Impedance (Ω)	50



MECHANICAL SPECIFICATIONS

Connectors	2 X 7/16 Female
Connector Position	Bottom
Survival Wind Speed km/h (mph)	200 (125)
Front Windload N @ 160 km/h (lbs @100 mph)	970 (220)
Lateral Windload N @ 160 km/h (lbs @100 mph)	200 (45)
Radome Color	Grey, paintable
Humidity	100%
Antenna Weight kg (lbs)	20 (44)
Antenna Dimension mm (in) H X W X D	1985 X 310 X 110 (78 X 12 X 4)

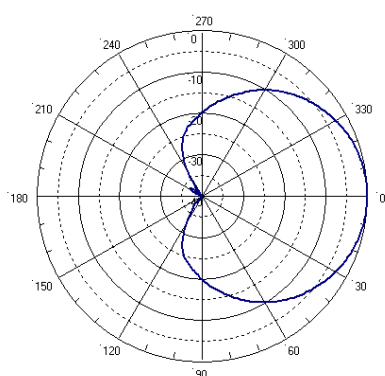

H&V Pattern

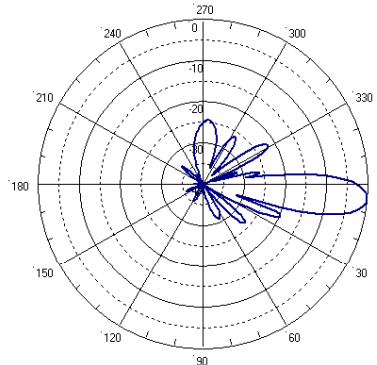

RYMSA Telecom Group (Headquarters)
 Crtra. Campo Real, km. 2.100
 28500 Arganda del Rey (Madrid)-Spain
 Phone : + 34 91 876 06 80
 Fax : + 34 91 875 75 32
 telecom.commercial@rymsa.com



RYMSA México: telecom.commercial@rymsa.com
 Phone: + 52 55 1106 2623
 RYMSA Wireless U.S.A: sales@rymsawireless.com
 Phone: + 1 888 622 6095
 www.rymsawireless.com

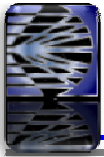

SINGLE-BAND PANEL ANTENNA

BAND 900

870 - 960

H64° V10.5°

Fixed Tilt 0°,2°,4°,6°

AT42-664TX

ELECTRICAL SPECIFICATIONS

BAND 900

Antenna Model	AT42-664TX
Polarization	± 45°
Frequency (MHz)	870 - 960
Horizontal Beamwidth	64°
Vertical Beamwidth	10.5°
Gain (dBi)	16.6
Vertical Electrical Tilt	FIXED 0°,2°,4°,6°
Upper Sidelobe Suppression for the 1 st lobe above main beam (dB)	22
Front-to-Back Ratio @ 180° ± 20° (dB)	> 30
VSWR	< 1.4 : 1
Cross Polar Ratio @ ± 60° (dB) <i>Typically</i>	> 10
Isolation Between Ports	> 30
Maximum Power Per Input (W)	500
Intermodulation (dBc)	< - 150
Impedance (Ω)	50

MECHANICAL SPECIFICATIONS

Connectors	2 X 7/16 Female
Connector Position	Bottom
Survival Wind Speed km/h (mph)	200 (125)
Front Windload N @ 160 km/h (lbs @100 mph)	970 (220)
Lateral Windload N @ 160 km/h (lbs @100 mph)	200 (45)
Radome Color	Grey, paintable
Humidity	100%
Antenna Weight kg (lbs)	18 (40)
Antenna Dimension mm (in) H X W X D	1985 X 310 X 110 (78 X 12 X 4)

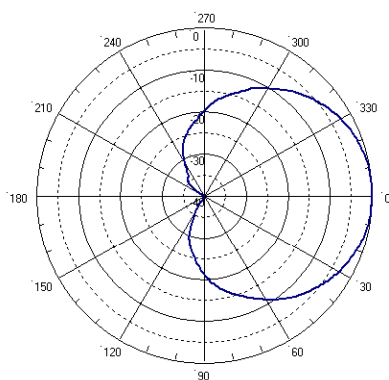

H&V Pattern

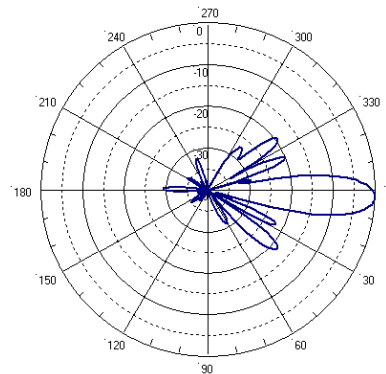

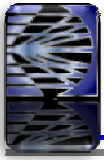

SINGLE-BAND PANEL ANTENNA

BAND 900

AT42-684TX

870 - 960

H64° V7.2°

Fixed Tilt 0°,2°,4°,6°

ELECTRICAL SPECIFICATIONS

BAND 900

Antenna Model	AT42-684TX
Polarization	± 45°
Frequency (MHz)	870 - 960
Horizontal Beamwidth	64°
Vertical Beamwidth	7.2°
Gain (dBi)	17.5
Vertical Electrical Tilt	FIXED 0°, 2°, 4°, 6°
Upper Sidelobe Suppression for the 1 st lobe above main beam (dB)	16
Front-to-Back Ratio @ 180° ± 20° (dB)	> 30
VSWR	< 1.4 : 1
Cross Polar Ratio @ ± 60° (dB) <i>Typically</i>	> 10
Isolation Between Ports	> 30
Maximum Power Per Input (W)	500
Intermodulation (dBc)	< - 150
Impedance (Ω)	50



MECHANICAL SPECIFICATIONS

Connectors	2 X 7/16 Female
Connector Position	Bottom
Survival Wind Speed km/h (mph)	200 (125)
Front Windload N @ 160 km/h (lbs @100 mph)	1270 (285)
Lateral Windload N @ 160 km/h (lbs @100 mph)	260 (60)
Radome Color	Grey, paintable
Humidity	100%
Antenna Weight kg (lbs)	22 (48)
Antenna Dimension mm (in) H X W X D	2530 X 310 X 110 (100 X 12 X 4)

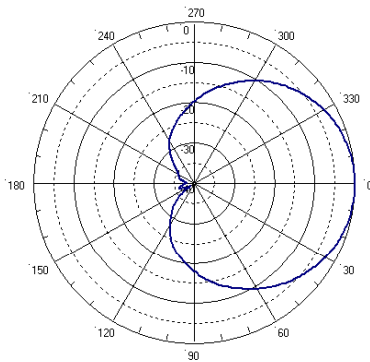

H&V Pattern

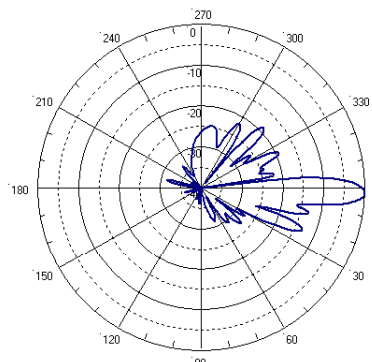

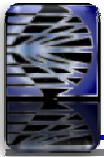

SINGLE-BAND PANEL ANTENNA

BAND 900

870 - 960

H64° V7.4°

Variable Tilt 0°-8°

AT42-684TV

ELECTRICAL SPECIFICATIONS

BAND 900

Antenna Model	AT42-684TV
Polarization	± 45°
Frequency (MHz)	870 - 960
Horizontal Beamwidth	64°
Vertical Beamwidth	7.4°
Gain (dBi)	17.5
Vertical Electrical Tilt	VARIABLE 0°-8°
Upper Sidelobe Suppression for the 1 st lobe above main beam (dB)	17
Front-to-Back Ratio @ 180° ± 20° (dB)	> 30
VSWR	< 1.4 : 1
Cross Polar Ratio @ ± 60° (dB) <i>Typically</i>	> 10
Isolation Between Ports	> 30
Maximum Power Per Input (W)	500
Intermodulation (dBc)	< - 150
Impedance (Ω)	50

MECHANICAL SPECIFICATIONS

Connectors	2 X 7/16 Female
Connector Position	Bottom
Survival Wind Speed km/h (mph)	200 (125)
Front Windload N @ 160 km/h (lbs @100 mph)	1270 (285)
Lateral Windload N @ 160 km/h (lbs @100 mph)	260 (60)
Radome Color	Grey, paintable
Humidity	100%
Antenna Weight kg (lbs)	24 (53)
Antenna Dimension mm (in) H X W X D	2530 X 310 X 110 (100 X 12 X 4)

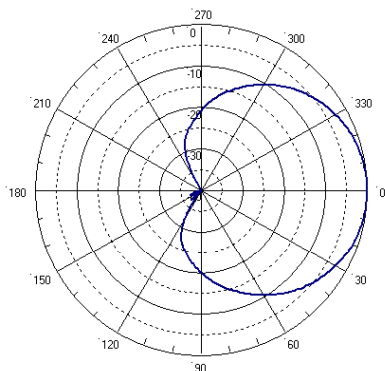

H&V Pattern

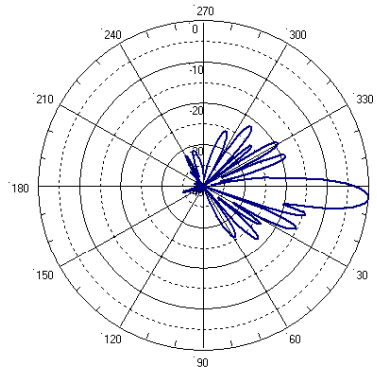

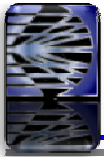

SINGLE-BAND PANEL ANTENNA

BAND 900

870 - 960

H88° V14.5°

Fixed Tilt 0°,2°,4°,6°

AT42-646 TX

ELECTRICAL SPECIFICATIONS

BAND 900

Antenna Model	AT42-646TX
Polarization	± 45°
Frequency (MHz)	870 - 960
Horizontal Beamwidth	88°
Vertical Beamwidth	14.5°
Gain (dBi)	14
Vertical Electrical Tilt	FIXED 0°,2°,4°,6°
Upper Sidelobe Suppression for the 1 st lobe above main beam (dB)	18
Front-to-Back Ratio @ 180° ± 20° (dB)	> 23
VSWR	< 1.4 : 1
Cross Polar Ratio @ ± 60° (dB) <i>Typically</i>	> 12
Isolation Between Ports	> 30
Maximum Power Per Input (W)	500
Intermodulation (dBc)	< - 150
Impedance (Ω)	50



MECHANICAL SPECIFICATIONS

Connectors	2 X 7/16 Female
Connector Position	Bottom
Survival Wind Speed km/h (mph)	200 (125)
Front Windload N @ 160 km/h (lbs @100 mph)	670 (150)
Lateral Windload N @ 160 km/h (lbs @100 mph)	130 (30)
Radome Color	Grey, paintable
Humidity	100%
Antenna Weight kg (lbs)	13 (28)
Antenna Dimension mm (in) H X W X D	1340 X 310 X 110 (53 X 12 X 4)

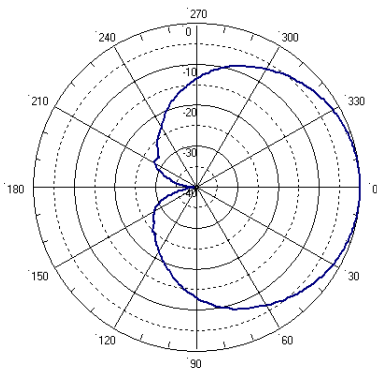

H&V Pattern

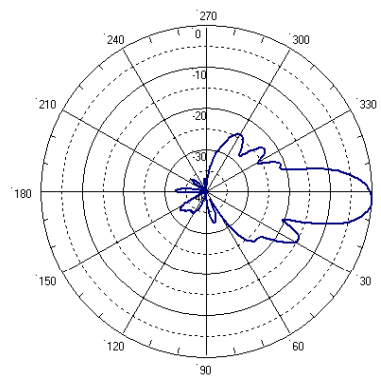



SINGLE-BAND PANEL ANTENNA

BAND 900

870 - 960

H88° V14.5°

Variable Tilt 0°-10°

AT42-646TV

ELECTRICAL SPECIFICATIONS

BAND 900

Antenna Model	AT42-646TV
Polarization	± 45°
Frequency (MHz)	870 - 960
Horizontal Beamwidth	88°
Vertical Beamwidth	14.5°
Gain (dBi)	14
Vertical Electrical Tilt	VARIABLE 0°-10°
Upper Sidelobe Suppression for the 1 st lobe above main beam (dB)	17
Front-to-Back Ratio @ 180° ± 20° (dB)	> 23
VSWR	< 1.4 : 1
Cross Polar Ratio @ ± 60° (dB) <i>Typically</i>	> 12
Isolation Between Ports	> 30
Maximum Power Per Input (W)	500
Intermodulation (dBc)	< -150
Impedance (Ω)	50



MECHANICAL SPECIFICATIONS

Connectors	2 X 7/16 Female
Connector Position	Bottom
Survival Wind Speed km/h (mph)	200 (125)
Front Windload N @ 160 km/h (lbs @100 mph)	670 (150)
Lateral Windload N @ 160 km/h (lbs @100 mph)	130 (30)
Radome Color	Grey, paintable
Humidity	100%
Antenna Weight kg (lbs)	15 (33)
Antenna Dimension mm (in) H X W X D	1340 X 310 X 110 (52 X 12 X 4)

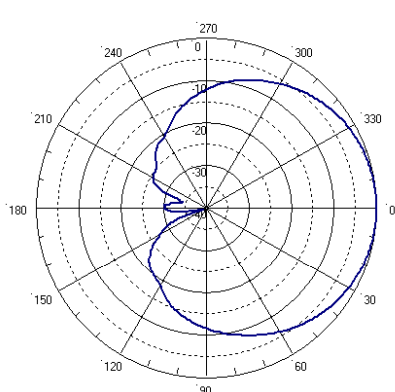

H&V Pattern

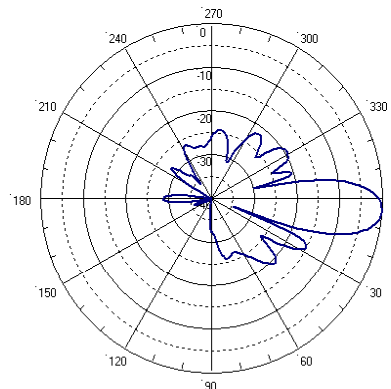

RYMSA Telecom Group (Headquarters)
 Crtra. Campo Real, km. 2.100
 28500 Arganda del Rey (Madrid)-Spain
 Phone : +34 91 876 06 80
 Fax : +34 91 875 75 32
 telecom.commercial@rymsa.com



RYMSA México: telecom.commercial@rymsa.com
 Phone: +52 55 1106 2623
 RYMSA Wireless U.S.A: sales@rymsawireless.com
 Phone: +1 888 622 6095
 www.rymsawireless.com

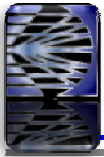

SINGLE-BAND PANEL ANTENNA

BAND 900

AT42-666TX

870 - 960

H88° V10.2°

Fixed Tilt 0°,2°,4°,6°

ELECTRICAL SPECIFICATIONS

BAND 900

Antenna Model	AT42-666TX
Polarization	± 45°
Frequency (MHz)	870 - 960
Horizontal Beamwidth	88°
Vertical Beamwidth	10.2°
Gain (dBi)	15.5
Vertical Electrical Tilt	FIXED 0°,2°,4°,6°
Upper Sidelobe Suppression for the 1 st lobe above main beam (dB)	20
Front-to-Back Ratio @ 180° ± 20° (dB)	> 25
VSWR	< 1.4 : 1
Cross Polar Ratio @ ± 60° (dB) <i>Typically</i>	> 10
Isolation Between Ports	> 30
Maximum Power Per Input (W)	500
Intermodulation (dBc)	< - 150
Impedance (Ω)	50



MECHANICAL SPECIFICATIONS

Connectors	2 X 7/16 Female
Connector Position	Bottom
Survival Wind Speed (km/h)	200 (125)
Front Windload N @ 160 km/h (lbs @100 mph)	970 (220)
Lateral Windload N @ 160 km/h (lbs @100 mph)	200 (45)
Radome Color	Grey, paintable
Humidity	100%
Antenna Weight kg (lbs)	18 (40)
Antenna Dimension mm (in) H X W X D	1985 X 310 X 110 (78 X 12 X 4)

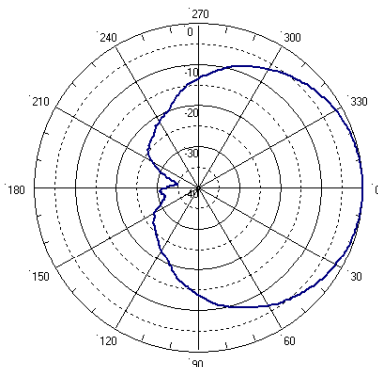

H&V Pattern

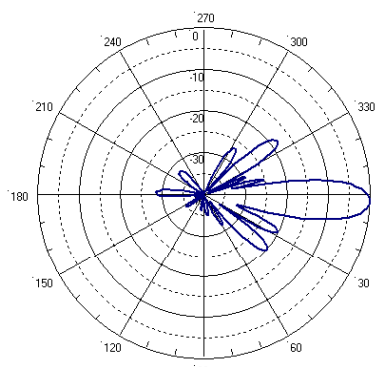



SINGLE-BAND PANEL ANTENNA

BAND 900

870 - 960

H88° V10.2°

Variable Tilt 0°-10°

AT42-666TV

ELECTRICAL SPECIFICATIONS

BAND 900

Antenna Model	AT42-666TV
Polarization	± 45°
Frequency (MHz)	870 - 960
Horizontal Beamwidth	88°
Vertical Beamwidth	10.2°
Gain (dBi)	15.5
Vertical Electrical Tilt	VARIABLE 0°-10°
Upper Sidelobe Suppression for the 1 st lobe above main beam (dB)	17
Front-to-Back Ratio @ 180° ± 20° (dB)	> 25
VSWR	< 1.4 : 1
Cross Polar Ratio @ ± 60° (dB) <i>Typically</i>	> 10
Isolation Between Ports	> 30
Maximum Power Per Input (W)	500
Intermodulation (dBc)	< - 150
Impedance (Ω)	50

MECHANICAL SPECIFICATIONS

Connectors	2 X 7/16 Female
Connector Position	Bottom
Survival Wind Speed km/h (mph)	200 (125)
Front Windload N @ 160 km/h (lbs @100 mph)	970 (220)
Lateral Windload N @ 160 km/h (lbs @100 mph)	200 (45)
Radome Color	Grey, paintable
Humidity	100%
Antenna Weight kg (lbs)	20 (44)
Antenna Dimension mm (in) H X W X D	1985 X 310 X 110 (78 X 12 X 4)

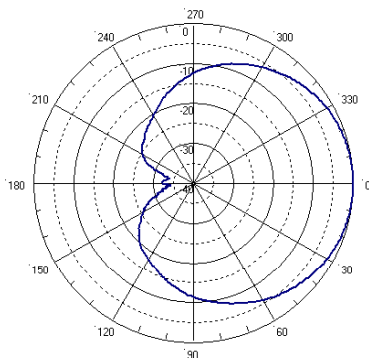

H&V Pattern

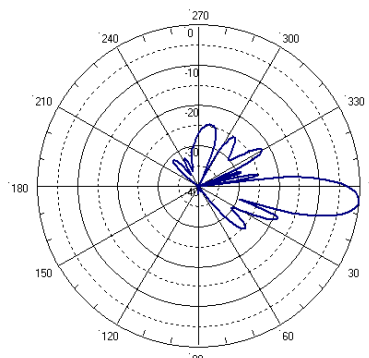

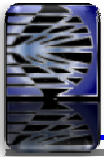

SINGLE-BAND PANEL ANTENNA

BAND 900

870 - 960

H88° V7.4°

Fixed Tilt 0°,2°,4°,6°

AT42-686TX

ELECTRICAL SPECIFICATIONS

BAND 900

Antenna Model	AT42-686TX
Polarization	± 45°
Frequency (MHz)	870 - 960
Horizontal Beamwidth	88°
Vertical Beamwidth	7.4°
Gain (dBi)	16.2
Vertical Electrical Tilt	FIXED 0°,2°,4°,6°
Upper Sidelobe Suppression for the 1 st lobe above main beam (dB)	19
Front-to-Back Ratio @ 180° ± 20° (dB)	> 25
VSWR	< 1.4 : 1
Cross Polar Ratio @ ± 60° (dB) <i>Typically</i>	> 10
Isolation Between Ports	> 30
Maximum Power Per Input (W)	500
Intermodulation (dBc)	< - 150
Impedance (Ω)	50



MECHANICAL SPECIFICATIONS

Connectors	2 X 7/16 Female
Connector Position	Bottom
Survival Wind Speed km/h (mph)	200 (125)
Front Windload N @ 160 km/h (lbs @100 mph)	1270 (285)
Lateral Windload N @ 160 km/h (lbs @100 mph)	260 (60)
Radome Color	Grey, paintable
Humidity	100%
Antenna Weight kg (lbs)	22 (48)
Antenna Dimension mm (in) H X W X D	2530 X 310 X 110 (100 X 12 X 4)

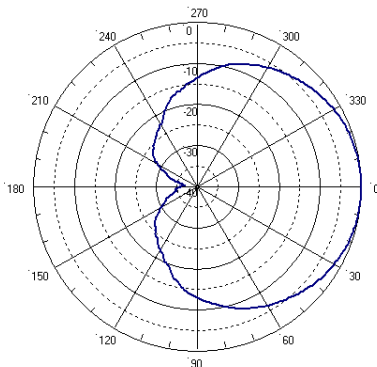

H&V Pattern

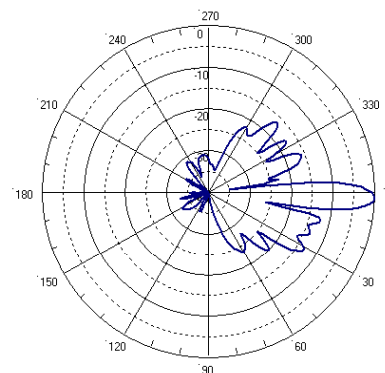

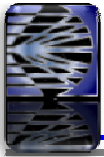

SINGLE-BAND PANEL ANTENNA

BAND 900

870 - 960

H88° V7.1°

Variable Tilt 0°-8°

AT42-686TV

ELECTRICAL SPECIFICATIONS

BAND 900

Antenna Model	AT42-686TV
Polarization	± 45°
Frequency (MHz)	870 - 960
Horizontal Beamwidth	88°
Vertical Beamwidth	7.1°
Gain (dBi)	16.2
Vertical Electrical Tilt	VARIABLE 0°-8°
Upper Sidelobe Suppression for the 1 st lobe above main beam (dB)	16
Front-to-Back Ratio @ 180° ± 20° (dB)	> 22
VSWR	< 1.4 : 1
Cross Polar Ratio @ ± 60° (dB) <i>Typically</i>	> 10
Isolation Between Ports	> 30
Maximum Power Per Input (W)	500
Intermodulation (dBc)	< - 150
Impedance (Ω)	50

MECHANICAL SPECIFICATIONS

Connectors	2 X 7/16 Female
Connector Position	Bottom
Survival Wind Speed km/h (mph)	200 (125)
Front Windload N @ 160 km/h (lbs @100 mph)	1270 (285)
Lateral Windload N @ 160 km/h (lbs @100 mph)	260 (60)
Radome Color	Grey, paintable
Humidity	100%
Antenna Weight kg (lbs)	24 (53)
Antenna Dimension mm (in) H X W X D	2530 X 310 X 110 (100 X 12 X 4)

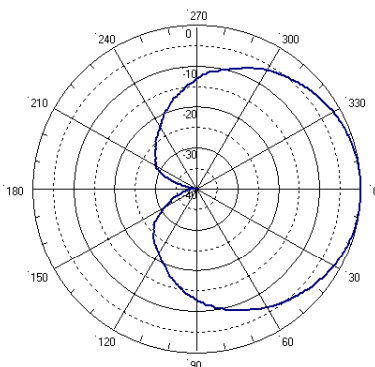

H&V Pattern

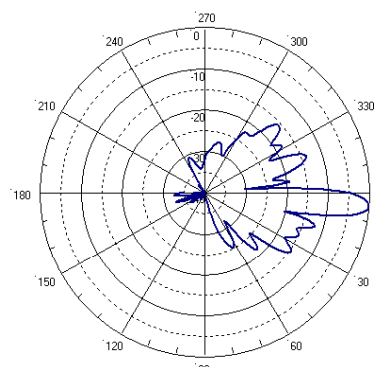



SINGLE-BAND PANEL ANTENNA

BROADBAND 1710-2170 MHZ

SINGLE-BAND PANEL ANTENNA								
BROADBAND 1710 - 2170 MHz								
Frequency	HBW	VBW	Gain (dbi)	Polarization	Tilt	Height mm (in)	Model	Page
1710 - 2170	30°	6.7 ⁰	21	Vertical	Fixed 0 ⁰ , 2 ⁰ , 4 ⁰ , 6 ⁰	1340 (53)	MGV1-800TX	59
1710 - 2170	65°	15°	15°	Vertical	Fixed 0 ⁰ , 2 ⁰ , 4 ⁰ , 6 ⁰	690 (21)	MGV3-400TX	60
1710 - 2170	65°	7°	17.6	Vertical	Fixed 0 ⁰ , 2 ⁰ , 4 ⁰ , 6 ⁰	1340 (53)	MGV3-800TX	61
1710 - 2170	65°	6°	18.6	Vertical	Fixed 0 ⁰ , 2 ⁰ , 4 ⁰ , 6 ⁰	1860 (73)	MGV3-900TX	62
1710 - 2170	90°	6°	16.6	Vertical	Fixed 0 ⁰ , 2 ⁰ , 4 ⁰ , 6 ⁰	1340 (53)	MGV5-800TX	63
1710 - 2170	90°	6°	17.7	Vertical	Fixed 0 ⁰ , 2 ⁰ , 4 ⁰ , 6 ⁰	1860 (73)	MGV5-900TX	64
1710 - 2170	30°	6°	21.2	± 45 ⁰	Fixed 0 ⁰ , 2 ⁰ , 4 ⁰ , 6 ⁰	1330 (52)	MGD1-800TX	65
1710 - 2170	30°	6.7 ⁰	21.2	± 45 ⁰	Variable 2 ⁰ - 12 ⁰	1330 (52)	MGD1-800TV	66
1710 - 2170	65°	15°	14.6	± 45 ⁰	Fixed 0 ⁰ , 2 ⁰ , 4 ⁰ , 6 ⁰	690 (21)	MGD3-400TX	67
1710 - 2170	65°	15°	15°	± 45 ⁰	Variable 0 ⁰ - 16 ⁰	690 (21)	MGD3-400TV	68
1710 - 2170	65°	15°	18	± 45 ⁰	Fixed 0 ⁰ , 2 ⁰ , 4 ⁰ , 6 ⁰	1340 (53)	MGD3-800TX	69
1710 - 2170	65°	6°	18	± 45 ⁰	Variable 0 ⁰ - 10 ⁰	1340 (53)	MGD3-800TV	70
1710 - 2170	65°	6°	19	± 45 ⁰	Fixed 0 ⁰ , 2 ⁰ , 4 ⁰ , 6 ⁰	1860 (73)	MGD3-900TX	71
1710 - 2170	65°	6°	19.2	± 45 ⁰	Variable 0 ⁰ - 6 ⁰	1860 (73)	MGD3-900TV	72
1710 - 2170	90°	6°	16.6	± 45 ⁰	Fixed 0 ⁰ , 2 ⁰ , 4 ⁰ , 6 ⁰	1340 (53)	MGD5-800TX	73
1710 - 2170	90°	6°	16.6	± 45 ⁰	Variable 0 ⁰ - 10 ⁰	1340 (53)	MGD5-800TV	74
1710 - 2170	90°	6°	18	± 45 ⁰	Fixed 0 ⁰ , 2 ⁰ , 4 ⁰ , 6 ⁰	1860 (73)	MGD5-900TX	75

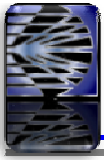

SINGLE-BAND PANEL ANTENNA

BROADBAND 1710-2170 MHz

MGV1-800TX

1710 - 2170		
1710-1880	1850-1990	1920-2170
H29° V7.2°	H27° V6.7°	H26° V6.4°
Fixed Tilt 0°,2°,4°,6°	Fixed Tilt 0°,2°,4°,6°	Fixed Tilt 0°,2°,4°,6°

ELECTRICAL SPECIFICATIONS

BROADBAND 1710-2170 MHz

Antenna Model	MGV1-800TX		
Polarization	Vertical		
Frequency	1710-2170		
	1710 - 1880	1850 - 1990	1920 - 2170
Horizontal Beamwidth	29°	27°	26°
Vertical Beamwidth	7.2°	6.7°	6.4°
Gain (dBi)	20.7	21	21.2
Vertical Electrical Tilt	FIXED 0°,2°,4°,6°	FIXED 0°,2°,4°,6°	FIXED 0°,2°,4°,6°
Upper Sidelobe Suppression for the 1 st lobe above main beam (dB)	20	20	20
Front-to-Back Ratio @ 180° ± 20° (dB)	> 30	> 29	> 29
VSWR	< 1.4 : 1	< 1.4 : 1	< 1.4 : 1
Maximum Power Per Input (W)	250		
Intermodulation (dBc)	< - 150		
Impedance (Ω)	50		



MECHANICAL SPECIFICATIONS

Connectors	1 X 7/16 Female
Connector Position	Bottom
Survival Wind Speed km/h (mph)	200 (125)
Front Windload N @ 160 km/h (lbs @ 100 mph)	620 (140)
Lateral Windload N @ 160 km/h (lbs @ 100 mph)	120 (30)
Radome Color	Grey, paintable
Humidity	100%
Antenna Weight kg (lbs)	13 (28)
Antenna Dimension mm (in) H X W X D	1340 X 300 X 100 (53 X 11 X 4)

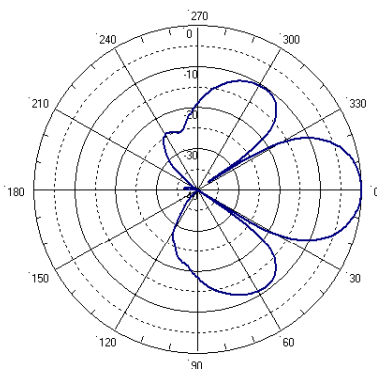

H&V Pattern

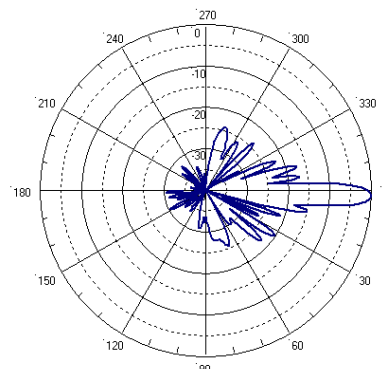

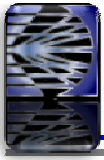

SINGLE-BAND PANEL ANTENNA

BROADBAND 1710-2170 MHZ

MGV3-400TX

1710 - 2170		
1710-1880	1850-1990	1920-2170
H67° V16°	H65° V15.5°	H63° V14.2°
Fixed Tilt 0°,2°,4°,6°	Fixed Tilt 0°,2°,4°,6°	Fixed Tilt 0°,2°,4°,6°

ELECTRICAL SPECIFICATIONS

BROADBAND 1710-2170 MHz

Antenna Model	MGV3-400TX		
Polarization	Vertical		
Frequency	1710-2170		
	1710 - 1880	1850 - 1990	1920 - 2170
Horizontal Beamwidth	67°	65°	63°
Vertical Beamwidth	16°	15.5°	14.2°
Gain (dBi)	14.7	15	15
Vertical Electrical Tilt	FIXED 0°,2°,4°,6°	FIXED 0°,2°,4°,6°	FIXED 0°,2°,4°,6°
Upper Sidelobe Suppression for the 1 st lobe above main beam (dB)	15	15	16
Front-to-Back Ratio @ 180° ± 20° (dB)	> 27	> 27	> 27
VSWR	< 1.4 : 1	< 1.4 : 1	< 1.4 : 1
Maximum Power Per Input (W)	250		
Intermodulation (dBc)	< - 150		
Impedance (Ω)	50		



MECHANICAL SPECIFICATIONS

Connectors	1 X 7/16 Female	
Connector Position	Bottom	
Survival Wind Speed	km/h (mph)	200 (125)
Front Windload	N @ 160 km/h (lbs @ 100 mph)	130 (29)
Lateral Windload	N @ 160 km/h (lbs @ 100 mph)	70 (16)
Radome Color	Grey, paintable	
Temperature Range	°C (F)	-55° to +60° (-67° to +140°)
Humidity	100%	
Antenna Weight	kg (lbs)	4 (9)
Antenna Dimension	mm (in) H X W X D	
	690 X 170 X 100 (27 X 7 X 4)	

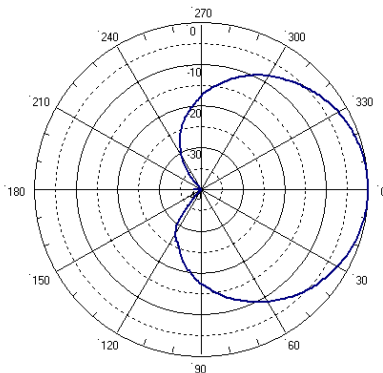

H&V Pattern

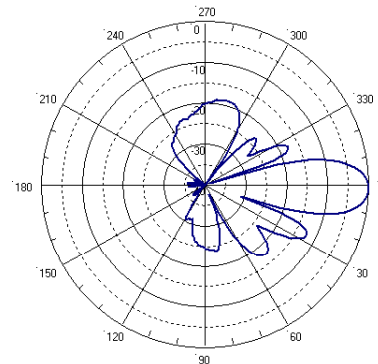



SINGLE-BAND PANEL ANTENNA

BROADBAND 1710-2170 MHZ

MGV3-800TX

1710 - 2170		
1710-1880	1850-1990	1920-2170
H69° V7°	H67° V6.6°	H64° V6.4°
Fixed Tilt	Fixed Tilt	Fixed Tilt
0°,2°,4°,6°	0°,2°,4°,6°	0°,2°,4°,6°

ELECTRICAL SPECIFICATIONS

BROADBAND 1710-2170 MHz

Antenna Model	MGV3-800TX		
Polarization	Vertical		
Frequency	1710-2170		
	1710 - 1880	1850 - 1990	1920 - 2170
Horizontal Beamwidth	69°	67°	64°
Vertical Beamwidth	7°	6.6°	6.4°
Gain (dBi)	17.5	17.6	18
Vertical Electrical Tilt	FIXED 0°,2°,4°,6°	FIXED 0°,2°,4°,6°	FIXED 0°,2°,4°,6°
Upper Sidelobe Suppression for the 1 st lobe above main beam (dB)	18	16	16
Front-to-Back Ratio @ 180° ± 20° (dB)	> 27	> 30	> 30
VSWR	< 1.4 : 1	< 1.4 : 1	< 1.4 : 1
Maximum Power Per Input (W)	250		
Intermodulation (dBc)	< - 150		
Impedance (Ω)	50		



MECHANICAL SPECIFICATIONS

Connectors	1 X 7/16 Female	
Connector Position	Bottom	
Survival Wind Speed km/h (mph)	200 (125)	
Front Windload N @ 160 km/h (lbs @ 100 mph)	320 (72)	
Lateral Windload N @ 160 km/h (lbs @ 100 mph)	170 (40)	
Radome Color	Grey, paintable	
Humidity	100%	
Antenna Weight kg (lbs)	7 (15)	
Antenna Dimension mm (in) H X W X D	1340 X 170 X 100 (53 X 7 X 4)	

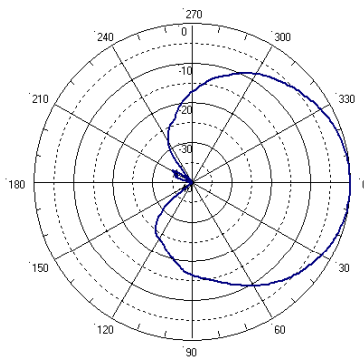

H&V Pattern

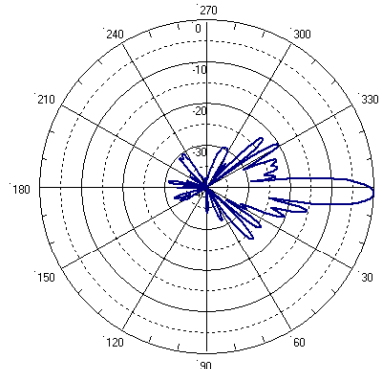

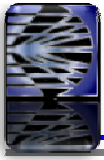

SINGLE-BAND PANEL ANTENNA

BROADBAND 1710-2170 MHz

MGV3-900TX

1710 - 2170		
1710-1880	1850-1990	1920-2170
H69° V5.2°	H67° V5°	H64° V4.7°
Fixed Tilt	Fixed Tilt	Fixed Tilt
0°,2°,4°,6°	0°,2°,4°,6°	0°,2°,4°,6°

ELECTRICAL SPECIFICATIONS

BROADBAND 1710-2170 MHz

Antenna Model	MGV3-900TX		
Polarization	Vertical		
Frequency	1710-2170		
	1710 - 1880	1850 - 1990	1920 - 2170
Horizontal Beamwidth	69°	67°	64°
Vertical Beamwidth	5.2°	5°	4.7°
Gain (dBi)	18.2	18.6	19
Vertical Electrical Tilt	FIXED 0°,2°,4°,6°	FIXED 0°,2°,4°,6°	FIXED 0°,2°,4°,6°
Upper Sidelobe Suppression for the 1 st lobe above main beam (dB)	18	16	16
Front-to-Back Ratio /Cpol @ 180° ± 20° (dB)	> 27	> 27	> 27
VSWR	< 1.4 : 1	< 1.4 : 1	< 1.4 : 1
Maximum Power Per Input (W)	250		
Intermodulation (dBc)	< - 150		
Impedance (Ω)	50		



MECHANICAL SPECIFICATIONS

Connectors	1 X 7/16 Female	
Connector Position	Bottom	
Survival Wind Speed	km/h (mph)	200 (125)
Front Windload	N @ 160 km/h (lbs @ 100 mph)	480 (108)
Lateral Windload	N @ 160 km/h (lbs @ 100 mph)	250 (56)
Radome Color	Grey, paintable	
Humidity	100%	
Antenna Weight	kg (lbs)	9 (20)
Antenna Dimension	mm (in) H X W X D	
	1860 X 170 X 100 (73 X 7 X 4)	

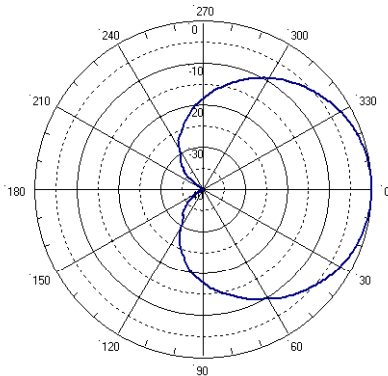

H&V Pattern

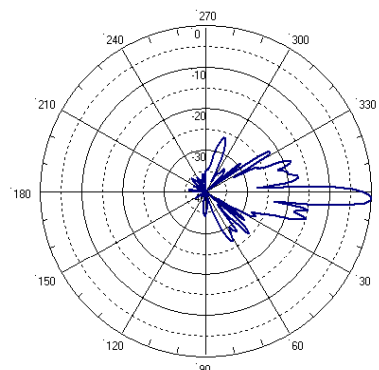

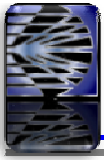

SINGLE-BAND PANEL ANTENNA

BROADBAND 1710-2170 MHz

MGV5-800TX

1710 - 2170		
1710-1880	1850-1990	1920-2170
H89° V7.6°	H87° V7.3°	H84° V6.5°
Fixed Tilt	Fixed Tilt	Fixed Tilt
0°,2°,4°,6°	0°,2°,4°,6°	0°,2°,4°,6°

ELECTRICAL SPECIFICATIONS

BROADBAND 1710-2170 MHz

Antenna Model	MGV5-800TX		
Polarization	Vertical		
Frequency	1710-2170		
	1710 - 1880	1850 - 1990	1920 - 2170
Horizontal Beamwidth	89°	87°	84°
Vertical Beamwidth	7.6°	7.3°	6.5°
Gain (dBi)	16.5	16.6	17
Vertical Electrical Tilt	FIXED 0°,2°,4°,6°	FIXED 0°,2°,4°,6°	FIXED 0°,2°,4°,6°
Upper Sidelobe Suppression for the 1 st lobe above main beam (dB)	17	17	17
Front-to-Back Ratio @ 180° ± 20° (dB)	> 25	> 25	> 25
VSWR	< 1.4 : 1	< 1.4 : 1	< 1.4 : 1
Maximum Power Per Input (W)	250		
Intermodulation (dBc)	< - 150		
Impedance (Ω)	50		



MECHANICAL SPECIFICATIONS

Connectors	1 X 7/16 Female	
Connector Position	Bottom	
Survival Wind Speed km/h (mph)	200 (125)	
Front Windload N @ 160 km/h (lbs @ 100 mph)	320 (72)	
Lateral Windload N @ 160 km/h (lbs @ 100 mph)	170 (40)	
Radome Color	Grey, paintable	
Humidity	100%	
Antenna Weight kg (lbs)	7 (15)	
Antenna Dimension mm (in) H X W X D	1340 X 170 X 100 (53 X 7 X 4)	

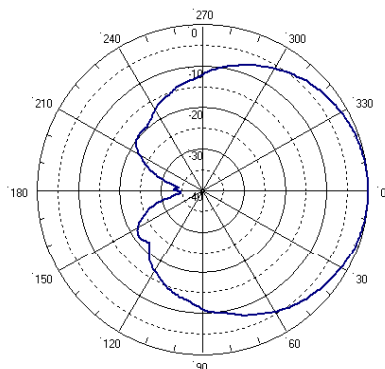

H&V Pattern

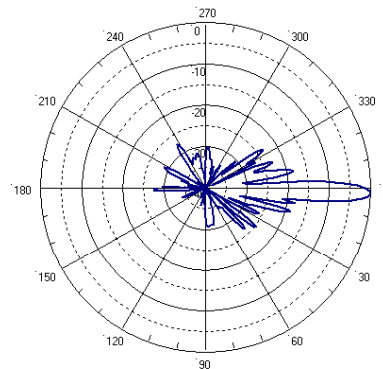

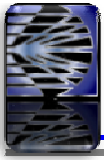

SINGLE-BAND PANEL ANTENNA

BROADBAND 1710-2170 MHz

MGV5-900TX

1710 - 2170		
1710-1880	1850-1990	1920-2170
H88° V5.6°	H86° V5.1°	H83° V4.8°
Fixed Tilt	Fixed Tilt	Fixed Tilt
0°,2°,4°,6°	0°,2°,4°,6°	0°,2°,4°,6°

ELECTRICAL SPECIFICATIONS

BROADBAND 1710-2170 MHz

Antenna Model	MGV5-900TX		
Polarization	Vertical		
Frequency	1710-2170		
	1710 - 1880	1850 - 1990	1920 - 2170
Horizontal Beamwidth	88°	86°	83°
Vertical Beamwidth	5.6°	5.1°	4.8°
Gain (dBi)	17.3	17.7	18
Vertical Electrical Tilt	FIXED 0°,2°,4°,6°	FIXED 0°,2°,4°,6°	FIXED 0°,2°,4°,6°
Upper Sidelobe Suppression for the 1 st lobe above main beam (dB)	18	18	18
Front-to-Back Ratio @ 180° ± 20° (dB)	> 25	> 25	> 25
VSWR	< 1.4 : 1	< 1.4 : 1	< 1.4 : 1
Maximum Power Per Input (W)	250		
Intermodulation (dBc)	< - 150		
Impedance (Ω)	50		



MECHANICAL SPECIFICATIONS

Connectors	1 X 7/16 Female	
Connector Position	Bottom	
Survival Wind Speed km/h (mph)	200 (125)	
Front Windload N @ 160 km/h (lbs @ 100 mph)	480 (108)	
Lateral Windload N @ 160 km/h (lbs @ 100 mph)	250 (56)	
Radome Color	Grey, paintable	
Humidity	100%	
Antenna Weight kg (lbs)	11 (25)	
Antenna Dimension mm (in) H X W X D	1860 X 170 X 100 (73 X 7 X 4)	

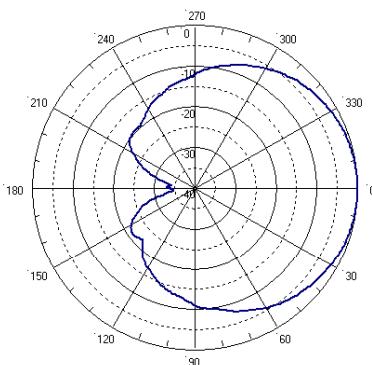

H&V Pattern

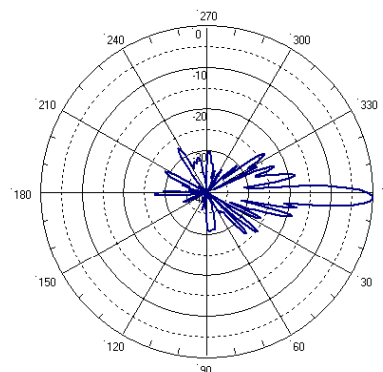

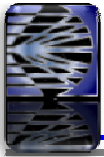

SINGLE-BAND PANEL ANTENNA

BROADBAND 1710-2170 MHz

MGD1-800TX

1710 - 2170		
1710-1880	1850-1990	1920-2170
H29° V7.1°	H27° V6.8°	H26° V6.2°
Fixed Tilt 0°,2°,4°,6°	Fixed Tilt 0°,2°,4°,6°	Fixed Tilt 0°,2°,4°,6°

ELECTRICAL SPECIFICATIONS

BROADBAND 1710-2170 MHz

Antenna Model	MGD1-800TX		
Polarization	± 45°		
Frequency	1710-2170		
	1710 - 1880	1850 - 1990	1920 - 2170
Horizontal Beamwidth	29°	27°	26°
Vertical Beamwidth	7.1°	6.8°	6.2°
Gain (dBi)	20.7	21.2	21.5
Vertical Electrical Tilt	FIXED 0°,2°,4°,6°	FIXED 0°,2°,4°,6°	FIXED 0°,2°,4°,6°
Upper Sidelobe Suppression for the 1 st lobe above main beam (dB)	20	20	20
Front-to-Back Ratio @ 180° ± 20° (dB)	> 30	> 30	> 30
VSWR	< 1.4 : 1	< 1.4 : 1	< 1.4 : 1
Cross Polar Ratio @ ± 60° (dB)	> 10	> 10	> 10
Isolation between Ports (dB)	> 30	> 30	> 30
Maximum Power Per Input (W)	250		
Intermodulation (dBc)	< - 150		
Impedance (Ω)	50		



MECHANICAL SPECIFICATIONS

Connectors	2 X 7/16 Female	
Connector Position	Bottom	
Survival Wind Speed km/h (mph)	200 (125)	
Front Windload N @ 160 km/h (lbs @ 100 mph)	620 (140)	
Lateral Windload N @ 160 km/h (lbs @ 100 mph)	120 (30)	
Radome Color	Grey, paintable	
Humidity	100%	
Antenna Weight kg (lbs)	13 (28)	
Antenna Dimension mm (in) H X W X D	1330 X 300 X 100 (52 X 11 X 3)	

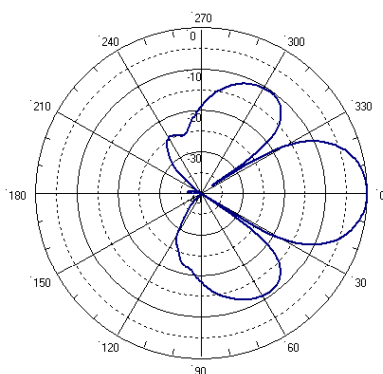

H&V Pattern

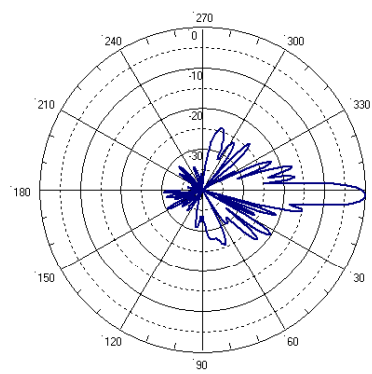



SINGLE-BAND PANEL ANTENNA

BROADBAND 1710-2170 MHZ

MGD1-800TV

1710 - 2170		
1710-1880	1850-1990	1920-2170
H38° V7°	H35° V6.7°	H32° V6.4°
Variable Tilt 2° - 12°	Variable Tilt 2° - 12°	Variable Tilt 2° - 12°

ELECTRICAL SPECIFICATIONS

BROADBAND 1710-2170 MHz

Antenna Model	MGD1-800TV		
Polarization	± 45°		
Frequency	1710-2170		
	1710 - 1880	1850 - 1990	1920 - 2170
Horizontal Beamwidth	38°	35°	32°
Vertical Beamwidth	7°	6.7°	6.4°
Gain (dBi)	20.1	21.2	21.3
Vertical Electrical Tilt	VARIABLE 2°-12°	VARIABLE 2°-12°	VARIABLE 2°-12°
Upper Sidelobe Suppression for the 1 st lobe above main beam (dB)	17	17	17
Front-to-Back Ratio @ 180° ± 20° (dB)	> 30	> 30	> 30
VSWR	< 1.4 : 1	< 1.4 : 1	< 1.4 : 1
Cross Polar Ratio @ ± 60° (dB)	> 10	> 10	> 10
Isolation between Ports (dB)	> 30	> 30	> 30
Maximum Power Per Input (W)	250		
Intermodulation (dBc)	< - 150		
Impedance (Ω)	50		



MECHANICAL SPECIFICATIONS

Connectors	2 X 7/16 Female	
Connector Position	Bottom	
Survival Wind Speed km/h (mph)	200 (125)	
Front Windload N @ 160 km/h (lbs @ 100 mph)	620 (140)	
Lateral Windload N @ 160 km/h (lbs @ 100 mph)	120 (30)	
Radome Color	Grey, paintable	
Humidity	100%	
Antenna Weight kg (lbs)	16 (35)	
Antenna Dimension mm (in) H X W X D	1330 X 300 X 100 (52 X 11 X 4)	

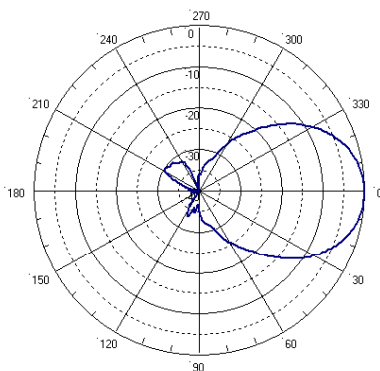

H&V Pattern

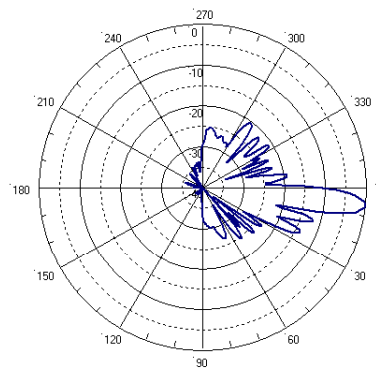

RYMSA Telecom Group (Headquarters)
 Crtra. Campo Real, km. 2.100
 28500 Arganda del Rey (Madrid)-Spain
 Phone : + 34 91 876 06 80
 Fax : + 34 91 875 75 32
 telecom.commercial@rymsa.com



RYMSA México: telecom.commercial@rymsa.com
 Phone: + 52 55 1106 2623
 RYMSA Wireless U.S.A: sales@rymsawireless.com
 Phone: + 1 888 622 6095
 www.rymsawireless.com

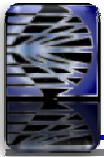

SINGLE-BAND PANEL ANTENNA

BROADBAND 1710-2170 MHZ

MGD3-400TX

1710 - 2170		
1710-1880	1850-1990	1920-2170
H69° V16.6°	H66° V15.8°	H63° V14.1°
Fixed Tilt	Fixed Tilt	Fixed Tilt
0°,2°,4°,6°	0°,2°,4°,6°	0°,2°,4°,6°

ELECTRICAL SPECIFICATIONS

BROADBAND 1710-2170 MHZ

Antenna Model	MGD3-400TX		
Polarization	Vertical		
Frequency	1710-2170		
	1710 - 1880	1850 - 1990	1920 - 2170
Horizontal Beamwidth	69°	66°	63°
Vertical Beamwidth	16.6°	15.8°	14.1°
Gain (dBi)	14.5	14.6	15
Vertical Electrical Tilt	FIXED 0°,2°,4°,6°	FIXED 0°,2°,4°,6°	FIXED 0°,2°,4°,6°
Upper Sidelobe Suppression for the 1 st lobe above main beam (dB)	14	14	14
Front-to-Back Ratio /Cpol @ 180° ± 20° (dB)	> 30	> 30	> 30
VSWR	< 1.4 : 1	< 1.4 : 1	< 1.4 : 1
Isolation Between Ports	> 30	> 30	> 30
Maximum Power Per Input (W)	250		
Intermodulation (dBc)	< - 150		
Impedance (Ω)	50		



MECHANICAL SPECIFICATIONS

Connectors	2 X 7/16 Female	
Connector Position	Bottom	
Survival Wind Speed	km/h (mph)	200 (125)
Front Windload	N @ 160 km/h (lbs @ 100 mph)	130 (29)
Lateral Windload	N @ 160 km/h (lbs @ 100 mph)	70 (16)
Radome Color	Grey, paintable	
Humidity	100%	
Antenna Weight	kg (lbs)	4 (9)
Antenna Dimension	mm (in) H X W X D	
	690 X 170 X 100 (21 X 7 X 4)	

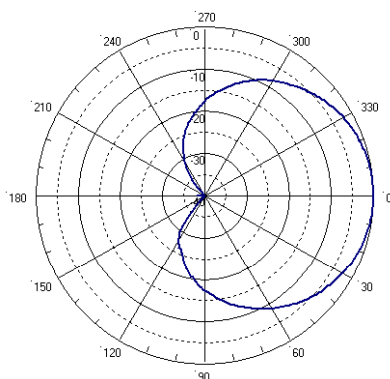

H&V Pattern

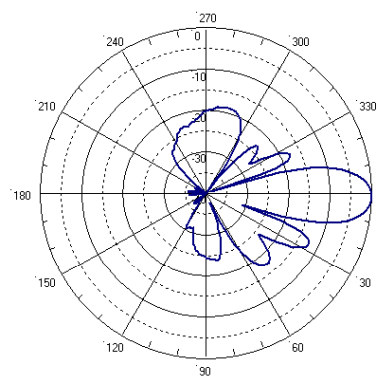

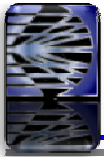

SINGLE-BAND PANEL ANTENNA

BROADBAND 1710-2170 MHz

MGD3-400TV

1710 - 2170		
1710-1880	1850-1990	1920-2170
H69° V14°	H66° V13°	H62° V12.5°
Variable Tilt 0° - 16°	Variable Tilt 0° - 16°	Variable Tilt 0° - 16°

ELECTRICAL SPECIFICATIONS

BROADBAND 1710-2170 MHz

Antenna Model	MGD3-400TV		
Polarization	± 45°		
Frequency	1710-2170		
	1710 - 1880	1850 - 1990	1920 - 2170
Horizontal Beamwidth	69°	66°	62°
Vertical Beamwidth	14°	13°	12.5°
Gain (dBi)	14.7	15	15.2
Vertical Electrical Tilt	VARIABLE 0°-16°	VARIABLE 0°-16°	VARIABLE 0°-16°
Upper Sidelobe Suppression for the 1 st lobe above main beam (dB)	17	17	17
Front-to-Back Ratio @ 180° ± 20° (dB)	> 30	> 30	> 28
VSWR	< 1.4 : 1	< 1.4 : 1	< 1.4 : 1
Cross Polar Ratio @ ± 60° (dB)	> 10	> 10	> 10
Isolation Between Ports	> 30	> 30	> 30
Maximum Power Per Input (W)	250		
Intermodulation (dBc)	< - 150		
Impedance (Ω)	50		



MECHANICAL SPECIFICATIONS

Connectors	2 X 7/16 Female	
Connector Position	Bottom	
Survival Wind Speed km/h (mph)	200 (125)	
Front Windload N @ 160 km/h (lbs @ 100 mph)	160 (36)	
Lateral Windload N @ 160 km/h (lbs @ 100 mph)	90 (20)	
Radome Color	Grey, paintable	
Humidity	100%	
Antenna Weight kg (lbs)	5 (11)	
Antenna Dimension mm (in) H X W X D	690 X 170 X 100 (27 X 7 X 4)	

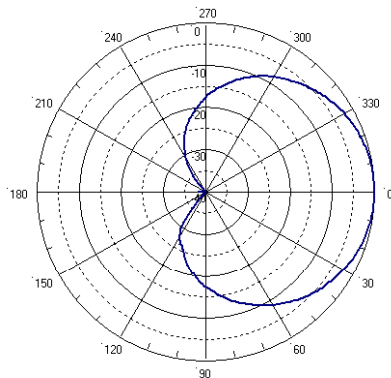

H&V Pattern

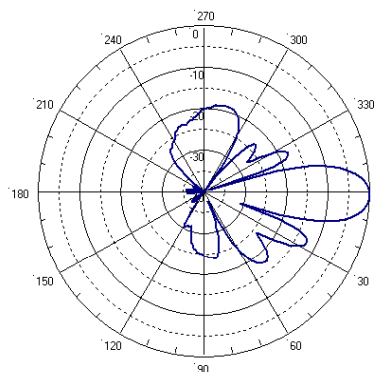

RYMSA Telecom Group (Headquarters)
 Ctra. Campo Real, km. 2.100
 28500 Arganda del Rey (Madrid)-Spain
 Phone : + 34 91 876 06 80
 Fax : + 34 91 875 75 32
 telecom.commercial@rymsa.com



RYMSA México: telecom.commercial@rymsa.com
 Phone: + 52 55 1106 2623
 RYMSA Wireless U.S.A: sales@rymsawireless.com
 Phone: + 1 888 622 6095
 www.rymsawireless.com

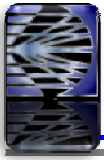

SINGLE-BAND PANEL ANTENNA

BROADBAND 1710-2170 MHz

MGD3-800TX

ELECTRICAL SPECIFICATIONS

BROADBAND 1710-2170 MHz

1710 - 2170		
1710-1880	1850-1990	1920-2170
H66° V7.2°	H64° V6.6°	H63° V6.3°
Fixed Tilt	Fixed Tilt	Fixed Tilt
0°,2°,4°,6°	0°,2°,4°,6°	0°,2°,4°,6°

Antenna Model	MGD3-800TX		
Polarization	± 45°		
Frequency	1710-2170		
	1710 - 1880	1850 - 1990	1920 - 2170
Horizontal Beamwidth	66°	64°	63°
Vertical Beamwidth	7.2°	6.6°	6.3°
Gain (dBi)	18	18	18.5
Vertical Electrical Tilt	FIXED 0°,2°,4°,6°	FIXED 0°,2°,4°,6°	FIXED 0°,2°,4°,6°
Upper Sidelobe Suppression for the 1 st lobe above main beam (dB)	20	20	20
Front-to-Back Ratio @ 180° ± 20° (dB)	> 30	> 30	> 30
VSWR	< 1.4 : 1	< 1.4 : 1	< 1.4 : 1
Cross Polar Ratio @ ± 60° (dB)	> 10	> 10	> 10
Isolation between Ports (dB)	> 30	> 30	> 30
Maximum Power Per Input (W)	250		
Intermodulation (dBc)	< - 150		
Impedance (Ω)	50		



MECHANICAL SPECIFICATIONS

Connectors	2 X 7/16 Female	
Connector Position	Bottom	
Survival Wind Speed	km/h (mph)	200 (125)
Front Windload		
N @ 160 km/h	(lbs @ 100 mph)	370 (85)
Lateral Windload		
N @ 160 km/h	(lbs @ 100 mph)	170 (40)
Radome Color	Grey, paintable	
Humidity	100%	
Antenna Weight	kg (lbs)	7 (15)
Antenna Dimension		
mm (in) H X W X D	1340 X 170 X 100 (53 X 7 X 4)	

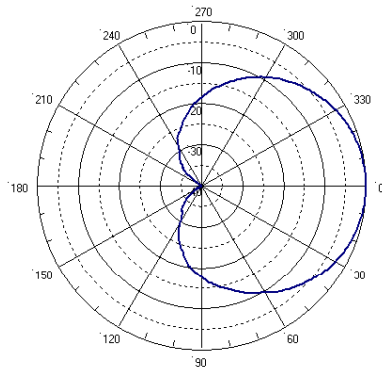

H&V Pattern

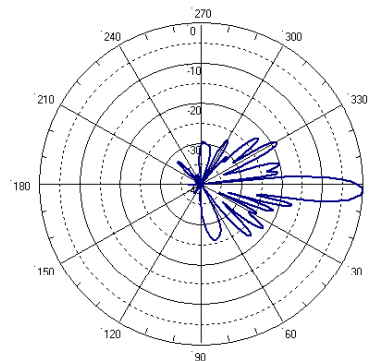

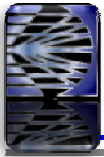

SINGLE-BAND PANEL ANTENNA

BROADBAND 1710-2170 MHZ

MGD3-800TV

ELECTRICAL SPECIFICATIONS

BROADBAND 1710-2170 MHz

1710 - 2170		
1710-1880	1850-1990	1920-2170
H67° V6.8°	H65° V6.6°	H63° V6.3°
Variable Tilt 0° - 10°	Variable Tilt 0° - 10°	Variable Tilt 0° - 10°

Antenna Model	MGD3-800TV		
Polarization	± 45°		
Frequency	1710-2170		
	1710 - 1880	1850 - 1990	1920 - 2170
Horizontal Beamwidth	67°	65°	63°
Vertical Beamwidth	6.8°	6.6°	6.3°
Gain (dBi)	17.6	18	18.2
Vertical Electrical Tilt	VARIABLE 0°-10°	VARIABLE 0°-10°	VARIABLE 0°-10°
Upper Sidelobe Suppression for the 1 st lobe above main beam (dB)	18	18	18
Front-to-Back Ratio @ 180° ± 20° (dB)	> 30	> 30	> 30
VSWR	< 1.4 : 1	< 1.4 : 1	< 1.4 : 1
Cross Polar Ratio @ ± 60° (dB)	> 10	> 10	> 10
Isolation between Ports (dB)	> 30	> 30	> 30
Maximum Power Per Input (W)	250		
Intermodulation (dBc)	< - 150		
Impedance (Ω)	50		



MECHANICAL SPECIFICATIONS

Connectors	2 X 7/16 Female	
Connector Position	Bottom	
Survival Wind Speed	km/h (mph)	200 (125)
Front Windload		
N @ 160 km/h	(lbs @ 100 mph)	320 (72)
Lateral Windload		
N @ 160 km/h	(lbs @ 100 mph)	170 (40)
Radome Color	Grey, paintable	
Humidity	100%	
Antenna Weight	kg (lbs)	8 (17)
Antenna Dimension		
mm (in) H X W X D	1340 X 170 X 100 (53 X 7 X 4)	

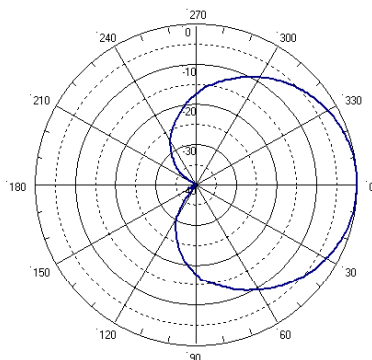

H&V Pattern

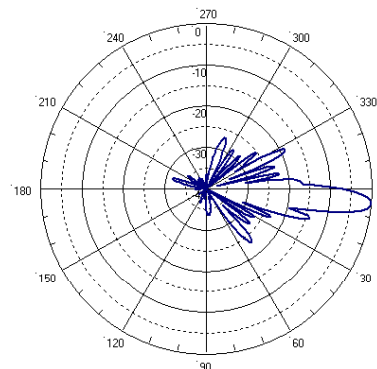

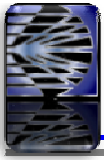

SINGLE-BAND PANEL ANTENNA

BROADBAND 1710-2170 MHZ

MGD3-900TX

1710 - 2170		
1710-1880	1850-1990	1920-2170
H68° V5.5°	H64° V5.3°	H62° V5°
Fixed Tilt 0°,2°,4°,6°	Fixed Tilt 0°,2°,4°,6°	Fixed Tilt 0°,2°,4°,6°

ELECTRICAL SPECIFICATIONS

BROADBAND 1710-2170 MHz

Antenna Model	MGD3-900TX		
Polarization	± 45°		
Frequency	1710-2170		
	1710 - 1880	1850 - 1990	1920 - 2170
Horizontal Beamwidth	68°	64°	62°
Vertical Beamwidth	5.5°	5.3°	5°
Gain (dBi)	18.6	19	19.3
Vertical Electrical Tilt	FIXED 0°,2°,4°,6°	FIXED 0°,2°,4°,6°	FIXED 0°,2°,4°,6°
Upper Sidelobe Suppression for the 1 st lobe above main beam (dB)	20	20	20
Front-to-Back Ratio @ 180° ± 20° (dB)	> 30	> 30	> 30
VSWR	< 1.4 : 1	< 1.4 : 1	< 1.4 : 1
Cross Polar Ratio @ ± 60° (dB)	> 10	> 10	> 10
Isolation between Ports (dB)	> 30	> 30	> 30
Maximum Power Per Input (W)	250		
Intermodulation (dBc)	< - 150		
Impedance (Ω)	50		



MECHANICAL SPECIFICATIONS

Connectors	2 X 7/16 Female
Connector Position	Bottom
Survival Wind Speed km/h (mph)	200 (125)
Front Windload N @ 160 km/h (lbs @ 100 mph)	480 (108)
Lateral Windload N @ 160 km/h (lbs @ 100 mph)	250 (56)
Radome Color	Grey, paintable
Humidity	100%
Antenna Weight kg (lbs)	9 (20)
Antenna Dimension mm (in) H X W X D	1860 X 170 X 100 (73 X 7 X 4)

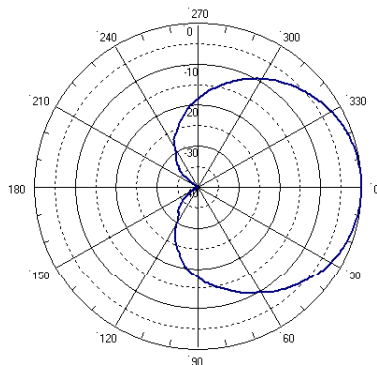

H&V Pattern

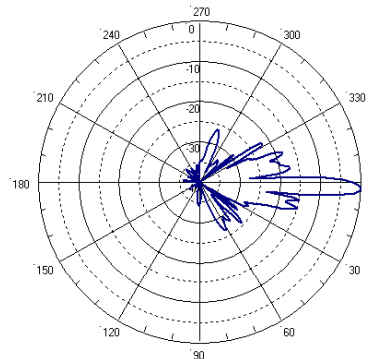

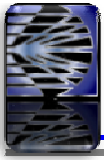

SINGLE-BAND PANEL ANTENNA

BROADBAND 1710-2170 MHz

MGD3-900TV

1710 - 2170		
1710-1880	1850-1990	1920-2170
H69° V5.1°	H66° V5°	H63° V5°
Variable Tilt 0° - 6°	Variable Tilt 0° - 6°	Variable Tilt 0° - 6°

ELECTRICAL SPECIFICATIONS

BROADBAND 1710-2170 MHz

Antenna Model	MGD3-900TV		
Polarization	± 45°		
Frequency	1710-2170		
	1710 - 1880	1850 - 1990	1920 - 2170
Horizontal Beamwidth	69°	66°	63°
Vertical Beamwidth	5,1°	5°	5°
Gain (dBi)	19	19.2	19.5
Vertical Electrical Tilt	VARIABLE 0°-6°	VARIABLE 0°-6°	VARIABLE 0°-6°
Upper Sidelobe Suppression for the 1 st lobe above main beam (dB)	17	17	17
Front-to-Back Ratio @ 180° ± 20° (dB)	> 30	> 30	> 30
VSWR	< 1.4 : 1	< 1.4 : 1	< 1.4 : 1
Cross Polar Ratio @ ± 60° (dB)	> 10	> 10	> 10
Isolation between Ports (dB)	> 30	> 30	> 30
Maximum Power Per Input (W)	250		
Intermodulation (dBc)	< - 150		
Impedance (Ω)	50		



MECHANICAL SPECIFICATIONS

Connectors	2 X 7/16 Female
Connector Position	Bottom
Survival Wind Speed km/h (mph)	200 (125)
Front Windload N @ 160 km/h (lbs @ 100 mph)	480 (108)
Lateral Windload N @ 160 km/h (lbs @ 100 mph)	250 (56)
Radome Color	Grey, paintable
Humidity	100%
Antenna Weight kg (lbs)	10 (22)
Antenna Dimension mm (in) H X W X D	1860 X 170 X 100 (73 X 7 X 4)

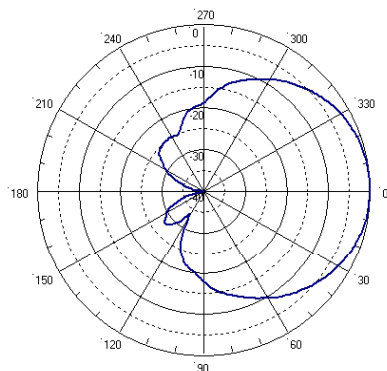

H&V Pattern

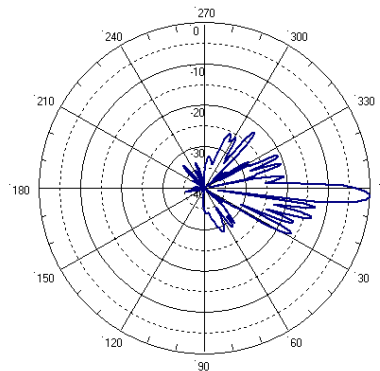

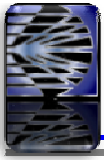

SINGLE-BAND PANEL ANTENNA

BROADBAND 1710-2170 MHz

MGD5-800TX

1710 - 2170		
1710-1880	1850-1990	1920-2170
H84° V7.5°	H83° V7°	H83° V6.5°
Fixed Tilt	Fixed Tilt	Fixed Tilt
0°,2°,4°,6°	0°,2°,4°,6°	0°,2°,4°,6°

ELECTRICAL SPECIFICATIONS

BROADBAND 1710-2170 MHz

Antenna Model	MGD5-800TX		
Polarization	± 45°		
Frequency	1710-2170		
	1710 - 1880	1850 - 1990	1920 - 2170
Horizontal Beamwidth	84°	83°	83°
Vertical Beamwidth	7.5°	7°	6.5°
Gain (dBi)	16.5	16.6	17
Vertical Electrical Tilt	FIXED 0°,2°,4°,6°	FIXED 0°,2°,4°,6°	FIXED 0°,2°,4°,6°
Upper Sidelobe Suppression for the 1 st lobe above main beam (dB)	16	16	20
Front-to-Back Ratio @ 180° ± 20° (dB)	> 30	> 30	> 30
VSWR	< 1.4 : 1	< 1.4 : 1	< 1.4 : 1
Cross Polar Ratio @ ± 60° (dB)	> 10	> 10	> 10
Isolation Between Ports (dB)	> 30	> 30	> 30
Maximum Power Per Input (W)	250		
Intermodulation (dBc)	< - 150		
Impedance (Ω)	50		



MECHANICAL SPECIFICATIONS

Connectors	2 X 7/16 Female	
Connector Position	Bottom	
Survival Wind Speed km/h (mph)	200 (125)	
Front Windload N @ 160 km/h (lbs @ 100 mph)	370 (85)	
Lateral Windload N @ 160 km/h (lbs @ 100 mph)	170 (40)	
Radome Color	Grey, paintable	
Humidity	100%	
Antenna Weight kg (lbs)	7 (15)	
Antenna Dimension mm (in) H X W X D	1340 X 170 X 100 (53 X 7 X 4)	

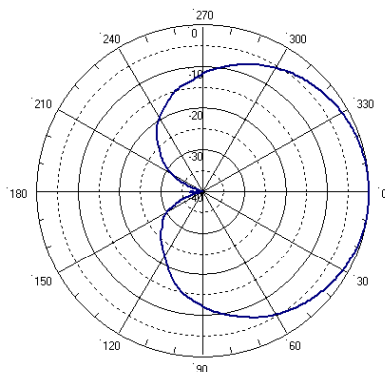

H&V Pattern

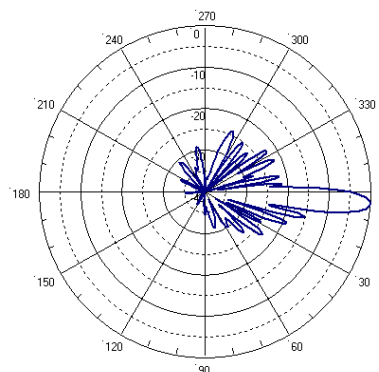

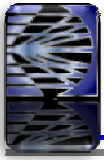

SINGLE-BAND PANEL ANTENNA

BROADBAND 1710-2170 MHz

MGD5-800TV

1710 - 2170		
1710-1880	1850-1990	1920-2170
H84° V7.2°	H83° V6.8°	H83° V6.5°
Variable Tilt 0° - 10°	Variable Tilt 0° - 10°	Variable Tilt 0° - 10°

ELECTRICAL SPECIFICATIONS

BROADBAND 1710-2170 MHz

Antenna Model	MGD5-800TV		
Polarization	± 45°		
Frequency	1710-2170		
	1710 - 1880	1850 - 1990	1920 - 2170
Horizontal Beamwidth	84°	83°	83°
Vertical Beamwidth	7.2°	6.8°	6.5°
Gain (dBi)	16.5	16.6	17
Vertical Electrical Tilt	VARIABLE 0°-10°	VARIABLE 0°-10°	VARIABLE 0°-10°
Upper Sidelobe Suppression for the 1 st lobe above main beam (dB)	17	17	17
Front-to-Back Ratio @ 180° ± 20° (dB)	> 26	> 26	> 24
VSWR	< 1.4 : 1	< 1.4 : 1	< 1.4 : 1
Cross Polar Ratio @ ± 60° (dB)	> 10	> 10	> 10
Isolation Between Ports (dB)	> 30	> 30	> 30
Maximum Power Per Input (W)	250		
Intermodulation (dBc)	< - 150		
Impedance (Ω)	50		



MECHANICAL SPECIFICATIONS

Connectors	2 X 7/16 Female
Connector Position	Bottom
Survival Wind Speed km/h (mph)	200 (125)
Front Windload N @ 160 km/h (lbs @ 100 mph)	320 (72)
Lateral Windload N @ 160 km/h (lbs @ 100 mph)	170 (40)
Radome Color	Grey, paintable
Humidity	100%
Antenna Weight kg (lbs)	7 (15)
Antenna Dimension mm (in) H X W X D	1340 X 170 X 100 (53 X 7 X 4)

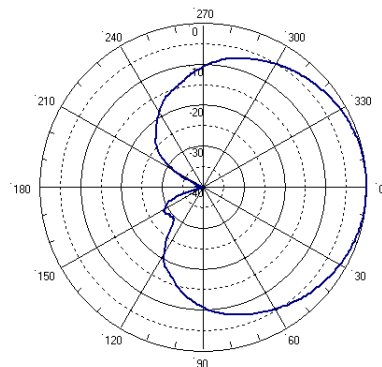

H&V Pattern

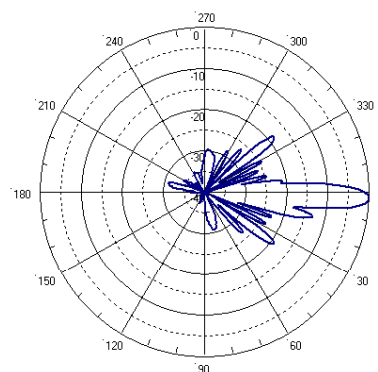

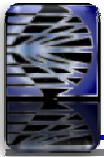

SINGLE-BAND PANEL ANTENNA

BROADBAND 1710-2170 MHZ

MGD5-900TX

1710 - 2170		
1710-1880	1850-1990	1920-2170
H89° V5.5°	H89° V5.3°	H87° V5°
Fixed Tilt	Fixed Tilt	Fixed Tilt
0°,2°,4°,6°	0°,2°,4°,6°	0°,2°,4°,6°

ELECTRICAL SPECIFICATIONS

BROADBAND 1710-2170 MHz

Antenna Model	MGD5-900TX		
Polarization	± 45°		
Frequency	1710-2170		
	1710 - 1880	1850 - 1990	1920 - 2170
Horizontal Beamwidth	89°	89°	87°
Vertical Beamwidth	5.5°	5.3°	5°
Gain (dBi)	17.6	18	18
Vertical Electrical Tilt	FIXED 0°,2°,4°,6°	FIXED 0°,2°,4°,6°	FIXED 0°,2°,4°,6°
Upper Sidelobe Suppression for the 1 st lobe above main beam (dB)	18	18	18
Front-to-Back Ratio @ 180° ± 20° (dB)	> 28	> 28	> 28
VSWR	< 1.4 : 1	< 1.4 : 1	< 1.4 : 1
Cross Polar Ratio @ ± 60° (dB)	> 10	> 10	> 10
Isolation Between Ports	> 30	> 30	> 30
Maximum Power Per Input (W)	250		
Intermodulation (dBc)	< - 150		
Impedance (Ω)	50		



MECHANICAL SPECIFICATIONS

Connectors	2 X 7/16 Female	
Connector Position	Bottom	
Survival Wind Speed km/h (mph)	200 (125)	
Front Windload N @ 160 km/h (lbs @ 100 mph)	480 (108)	
Lateral Windload N @ 160 km/h (lbs @ 100 mph)	250 (56)	
Radome Color	Grey, paintable	
Humidity	100%	
Antenna Weight kg (lbs)	9 (20)	
Antenna Dimension mm (in) H X W X D	1860 X 170 X 100 (73 X 7 X 4)	

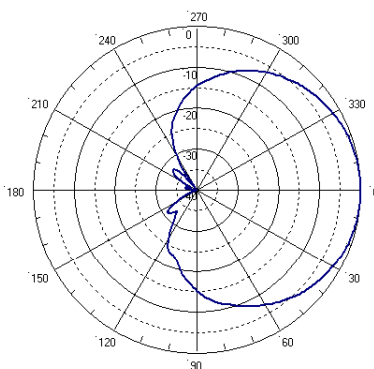

H&V Pattern

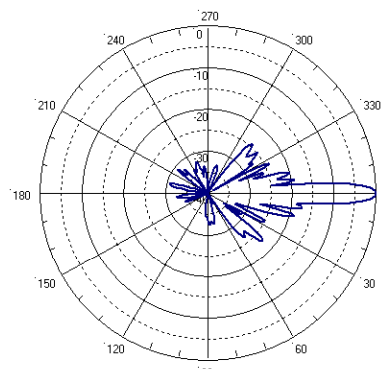

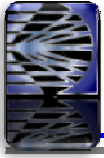

LOW BAND SIDE BY SIDE PANEL ANTENNA

BAND 900

LOW BAND SIDE BY SIDE								
2 X BAND 900								
Frequency	HBW	VBW	Gain (dbi)	Polarization	Tilt	Height mm (in)	Model	Page
824 - 960	65°	10°	16	± 45°	Variable 2°- 12°	2100 (83)	BAT40-664TV	77
824 - 960	65°	6°	16.5	± 45°	Variable 2°- 12°	2700 (106)	BAT40-684TV	78

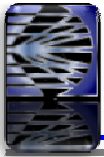

LOW BAND SIDE BY SIDE PANEL ANTENNA

BAND 900

2 X (824 - 960)

H69° V10°

Variable Tilt 2°-10°

BAT40-664 TV *

*Tentative specs.

ELECTRICAL SPECIFICATIONS

2 X BAND 900

Antenna Model	BAT40-664TV
Polarization	± 45°
Frequency (MHz)	2 X (824 - 960)
Horizontal Beamwidth	69°
Vertical Beamwidth	10°
Gain (dBi)	16
Vertical Electrical Tilt	VARIABLE 2°-10°
Upper Sidelobe Suppression for the 1 st lobe above main beam (dB)	15
Front-to-Back Ratio @180° ± 20° (dB)	> 25
VSWR	< 1.5 : 1
Cross Polar Ratio @ ± 60° (dB) Typically	> 8
Isolation Between Ports	> 25
Maximum Power Per Input (W)	500
Intermodulation (dBc)	< - 150
Impedance (Ω)	50



MECHANICAL SPECIFICATIONS

Connectors	4 X 7/16 Female
Connector Position	Bottom
Survival Wind Speed km/h (mph)	200 (125)
Front Windload N @ 160 km/h (lbs @100 mph)	1280 (288)
Lateral Windload N @ 160 km/h (lbs @100 mph)	290 (65)
Radome Color	Grey, paintable
Humidity	100%
Antenna Weight kg (lbs)	32 (71)
Antenna Dimension mm (in) H X W X D	2100 X 370 X 140 (83 X 15 X 3)



* Available in Fall 2010.

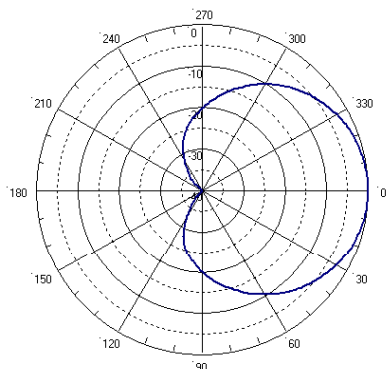

H&V Pattern

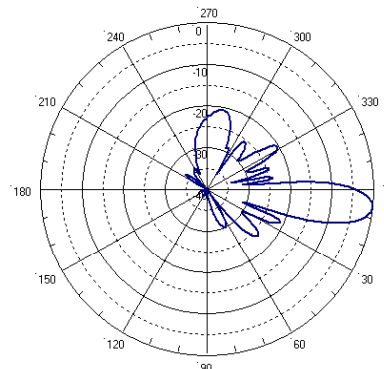

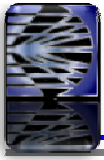

LOW BAND SIDE BY SIDE PANEL ANTENNA

BAND 900

2 X (824 - 960)

H69° V7.3°

Variable Tilt 2°-10°

BAT40-684 TV*

*Tentative specs.

ELECTRICAL SPECIFICATIONS

2 X BAND 900

Antenna Model	BAT40-684TV
Polarization	± 45°
Frequency (MHz)	2 X (824 - 960)
Horizontal Beamwidth	69°
Vertical Beamwidth	7.3°
Gain (dBi)	16.5
Vertical Electrical Tilt	VARIABLE 2°-10°
Upper Sidelobe Suppression for the 1 st lobe above main beam (dB)	15
Front-to-Back Ratio @180° ± 20° (dB)	> 25
VSWR	< 1.5 : 1
Cross Polar Ratio @ ± 60° (dB) <i>Typically</i>	> 8
Isolation Between Ports	> 25
Maximum Power Per Input (W)	500
Intermodulation (dBc)	< - 150
Impedance (Ω)	50



MECHANICAL SPECIFICATIONS

Connectors	4 X 7/16 Female
Connector Position	Bottom
Survival Wind Speed km/h (mph)	200 (125)
Front Windload N @ 160 km/h (lbs @100 mph)	380 (85)
Lateral Windload N @ 160 km/h (lbs @100 mph)	290 (65)
Radome Color	Grey, paintable
Humidity	100%
Antenna Weight kg (lbs)	40 (88)
Antenna Dimension mm (in) H X W X D	2700 X 370 X 140 (106 X 15 X 3)



* Available in Fall 2010.

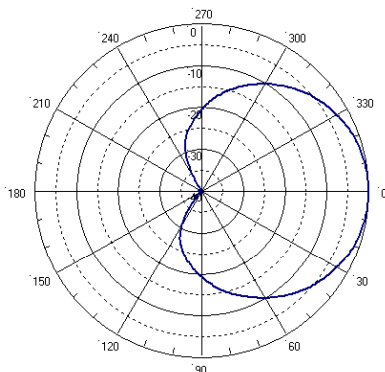

H&V Pattern

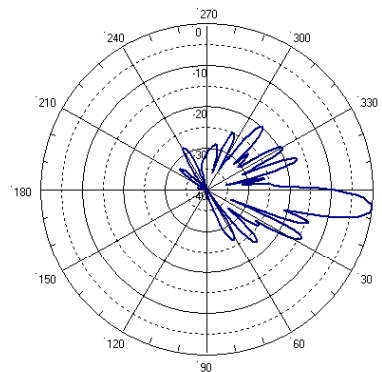



HIGH BAND SIDE BY SIDE PANEL ANTENNA

2 X BROADBAND 1710-2170

HIGH BAND SIDE BY SIDE PANEL ANTENNA								
2 X BROADBAND 1710 - 2170 MHz								
Frequency	HBW	VBW	Gain (dbi)	Polarization	Tilt	Height mm (in)	Model	Page
1710 - 1880	65°	15°	15	± 45°	Variable 0°- 12°	650 (25)	BGD3-400TV	80
1850 - 1990	65°	15°	15					
1920 - 2170	65°	15°	15					
1710 - 1880	65°	6°	18	± 45°	Fixed 0°, 2°, 4°, 6°	1340 (53)	BGD3-800TX	81
1850 - 1990	65°	6°	18					
1920 - 2170	65°	6°	18					
1710 - 1880	65°	6°	17.7	± 45°	Variable 0°- 10°	1340 (53)	BGD3-800TV	82
1850 - 1990	65°	6°	18.1					
1920 - 2170	65°	6°	18.2					
1710 - 1880	65°	6°	17.7	± 45°	Variable 0°- 10°	1440 (56)	BGRD3A-800TV	83
1850 - 1990	65°	6°	17.7					
1920 - 2170	65°	6°	18					

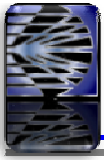

HIGH BAND SIDE BY SIDE PANEL ANTENNA

2 X BROADBAND 1710-2170

BGD3-400TV

2 X 1710 - 2170		
1710-1880	1850-1990	1920-2170
H65° V14°	H65° V13.5°	H64° V13°
Variable Tilt 0° - 12°	Variable Tilt 0° - 12°	Variable Tilt 0° - 12°

ELECTRICAL SPECIFICATIONS

2 X BROADBAND 1710-2170 MHz

Antenna Model	BGD3-400TV		
Polarization	± 45°		
Frequency	2 X (1710 – 2170)		
	1710 - 1880	1850 - 1990	1920 - 2170
Horizontal Beamwidth	65°	65°	64°
Vertical Beamwidth	14°	13.5°	13°
Gain (dBi)	15	15	15.3
Vertical Electrical Tilt	VARIABLE 0°-12°	VARIABLE 0°-12°	VARIABLE 0°-12°
Upper Sidelobe Suppression for the 1 st lobe above main beam (dB)	17	18	18
Front-to-Back Ratio @180° ± 20° (dB)	> 27	> 27	> 30
VSWR	< 1.4 : 1	< 1.4 : 1	< 1.4 : 1
Cross Polar Ratio @ ± 60° (dB) <i>Typically</i>	> 10	> 10	> 10
Isolation Between Ports (dB)	> 30	> 30	> 30
Interband Isolation (dB)	> 30 (1710-2170//1710-2170)		
Maximum Power Per Input (W)	250		
Intermodulation (dBc)	< - 150		
Impedance (Ω)	50		



MECHANICAL SPECIFICATIONS

Connectors	4 X 7/16 Female
Connector Position	Bottom
Survival Wind Speed km/h (mph)	200 (125)
Front Windload N @ 160 km/h (lbs @ 100 mph)	310 (70)
Lateral Windload N @ 160 km/h (lbs @ 100 mph)	60 (14)
Radome Color	Grey, paintable
Humidity	100%
Antenna Weight kg (lbs)	8 (17)
Antenna Dimension mm (in) H X W X D	650 X 300 X 90 (25 X 12 X 3)

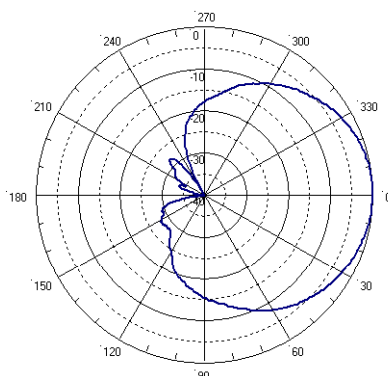

H&V Pattern

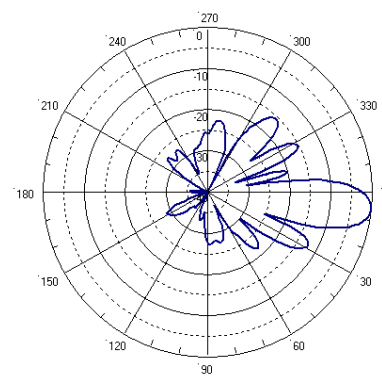



HIGH BAND SIDE BY SIDE PANEL ANTENNA

2 X BROADBAND 1710-2170

BGD3-800TX

2 X 1710 - 2170		
1710-1880	1850-1990	1920-2170
H65° V7.2°	H64° V6.3°	H63° V6°
Fixed Tilt 0°,2°,4°,6°	Fixed Tilt 0°,2°,4°,6°	Fixed Tilt 0°,2°,4°,6°

ELECTRICAL SPECIFICATIONS

2 X BROADBAND 1710-2170 MHz

Antenna Model	BGD3-800TX		
Polarization	± 45°		
Frequency	2 X (1710 – 2170)		
	1710 - 1880	1850 - 1990	1920 - 2170
Horizontal Beamwidth	65°	64°	63°
Vertical Beamwidth	7.2°	6.3°	6°
Gain (dBi)	18	18	18.2
Vertical Electrical Tilt	FIXED 0°,2°,4°,6°	FIXED 0°,2°,4°,6°	FIXED 0°,2°,4°,6°
Upper Sidelobe Suppression for the 1 st lobe above main beam (dB)	18	18	18
Front-to-Back Ratio @180° ± 20° (dB)	> 30	> 30	> 30
VSWR	< 1.4 : 1	< 1.4 : 1	< 1.4 : 1
Cross Polar Ratio @ ± 60° (dB) <i>Typically</i>	> 10	> 10	> 10
Isolation Between Ports (dB)	> 30	> 30	> 30
Interband Isolation (dB)	> 30 (1710-2170//1710-2170)		
Maximum Power Per Input (W)	250		
Intermodulation (dBc)	< - 150		
Impedance (Ω)	50		



MECHANICAL SPECIFICATIONS

Connectors	4 X 7/16 Female
Connector Position	Bottom
Survival Wind Speed km/h (mph)	200 (125)
Front Windload N @ 160 km/h (lbs @ 100 mph)	620 (140)
Lateral Windload N @ 160 km/h (lbs @ 100 mph)	120 (30)
Radome Color	Grey, paintable
Humidity	100%
Antenna Weight kg (lbs)	14 (30)
Antenna Dimension mm (in) H X W X D	1340 X 300 X 90 (53 X 11 X 3)

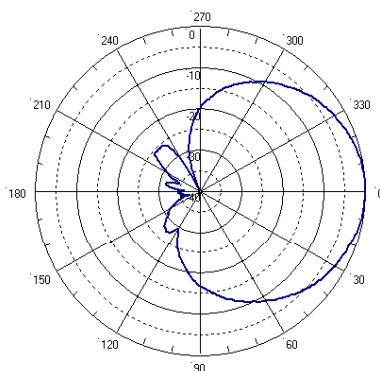

H&V Pattern

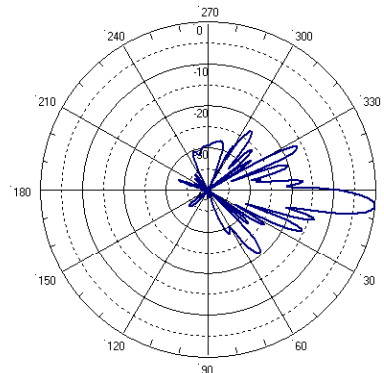

RYMSA Telecom Group (Headquarters)
 Crtra. Campo Real, km. 2.100
 28500 Arganda del Rey (Madrid)-Spain
 Phone : + 34 91 876 06 80
 Fax : + 34 91 875 75 32
 telecom.commercial@rymsa.com



RYMSA México: telecom.commercial@rymsa.com
 Phone: + 52 55 1106 2623
 RYMSA Wireless U.S.A: sales@rymsawireless.com
 Phone: + 1 888 622 6095
 www.rymsawireless.com

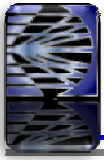

HIGH BAND SIDE BY SIDE PANEL ANTENNA

2 X BROADBAND 1710-2170

BGD3-800TV

ELECTRICAL SPECIFICATIONS

2 X BROADBAND 1710-2170 MHz

2 X 1710 - 2170		
1710-1880	1850-1990	1920-2170
H66° V6.5°	H64° V6.5°	H62° V6°
Variable Tilt 0° - 10°	Variable Tilt 0° - 10°	Variable Tilt 0° - 10°

Antenna Model	BGD3-800TV		
Polarization	± 45°		
Frequency	2 X (1710 - 2170)		
	1710 - 1880	1850 - 1990	1920 - 2170
Horizontal Beamwidth	66°	64°	62°
Vertical Beamwidth	6.5°	6.5°	6°
Gain (dBi)	17.7	18.1	18.2
Vertical Electrical Tilt	VARIABLE 0°-10°	VARIABLE 0°-10°	VARIABLE 0°-10°
Upper Sidelobe Suppression for the 1 st lobe above main beam (dB)	17	17	17
Front-to-Back Ratio @180° ± 20° (dB)	> 30	> 30	> 30
VSWR	< 1.4 : 1	< 1.4 : 1	< 1.4 : 1
Cross Polar Ratio @ ± 60° (dB) <i>Typically</i>	> 10	> 10	> 10
Isolation Between Ports (dB)	> 30	> 30	> 30
Interband Isolation (dB)	> 30 (1710-2170//1710-2170)		
Maximum Power Per Input (W)	250		
Intermodulation (dBc)	< - 150		
Impedance (Ω)	50		



MECHANICAL SPECIFICATIONS

Connectors	4 X 7/16 Female
Connector Position	Bottom
Survival Wind Speed km/h (mph)	200 (125)
Front Windload N @ 160 km/h (lbs @ 100 mph)	620 (140)
Lateral Windload N @ 160 km/h (lbs @ 100 mph)	120 (30)
Radome Color	Grey, paintable
Humidity	100%
Antenna Weight kg (lbs)	16 (35)
Antenna Dimension mm (in) H X W X D	1340 X 300 X 90 (53 X 11 X 3)

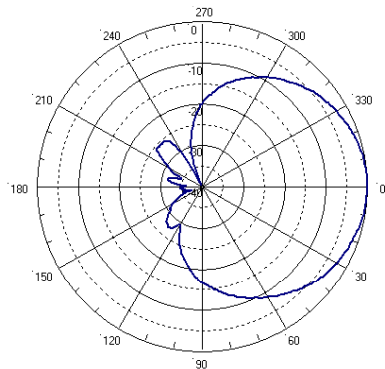

H&V Pattern

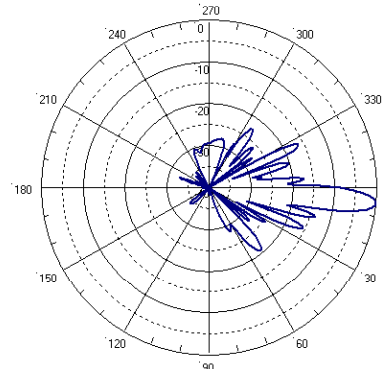

This antenna is available with variable electrical tilt 4°-14°



HIGH BAND SIDE BY SIDE PANEL ANTENNA

2 X BROADBAND 1710-2170

BGRD3A-800TV Integrated RET
Indep. Variable AZIMUTH

2 X 1710 - 2170		
1710-1880	1850-1990	1920-2170
H63° V6.5°	H63° V6.5°	H62° V6.3°
Variable Tilt 0° - 10°	Variable Tilt 0° - 10°	Variable Tilt 0° - 10°

ELECTRICAL SPECIFICATIONS

2 X BROADBAND 1710-2170 MHz

Antenna Model	BGRD3A-800TV			
Polarization	± 45°			
Frequency	2 X (1710 - 2170)			
	1710 - 1880	1850 - 1990	1920 - 2170	
	Horizontal Beamwidth	63°	63°	62°
	Vertical Beamwidth	6.5°	6.5°	6.3°
Gain (dBi)	17.7	17.7	18	
Vertical Electrical Tilt	VARIABLE 0°-10°	VARIABLE 0°-10°	VARIABLE 0°-10°	
Variable Azimuth	0°-18° (Integrated RET)			
Upper Sidelobe Suppression for the 1 st lobe above main beam (dB)	17	17	17	
Front-to-Back Ratio @180° ± 20° (dB)	> 30	> 30	> 30	
VSWR	< 1.4 : 1	< 1.4 : 1	< 1.4 : 1	
Cross Polar Ratio @ ± 60° (dB) <i>Typically</i>	> 10	> 10	> 10	
Isolation Between Ports (dB)	> 30	> 30	> 30	
Interband Isolation (dB)	> 30 (1710-2170//1710-2170)			
Maximum Power Per Input (W)	250			
Intermodulation (dBc)	< - 150			
Impedance (Ω)	50			

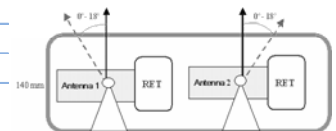
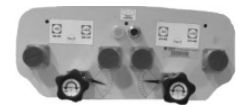

Disposition of the variable azimuth and the integrated RET

MECHANICAL SPECIFICATIONS

Connectors	4 X 7/16 Female		
Connector Position	Bottom		
Survival Wind Speed km/h (mph)	200 (125)		
Front Windload N @ 160 km/h (lbs @ 100 mph)	730 (165)		
Lateral Windload N @ 160 km/h (lbs @ 100 mph)	160 (40)		
Radome Color	Grey, paintable		
Humidity	100%		
Antenna Weight kg (lbs)	22 (48)		
Antenna Dimension mm (in) H X W X D	1440 X 340 X 140 (56 X 13 X 3)		

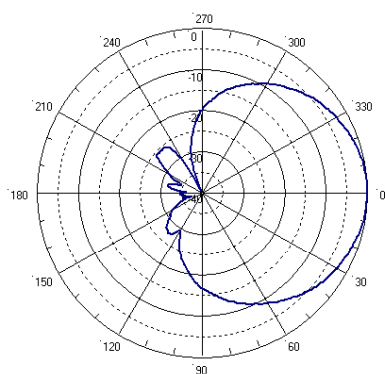

H&V Pattern

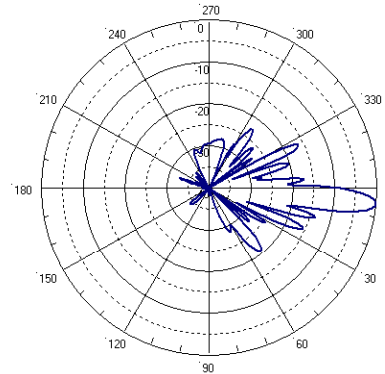



MULTI-BAND PANEL ANTENNA

DUAL BAND PANEL ANTENNA

MULTI - BAND PANEL ANTENNA								
DUAL-BAND PANEL ANTENNA								
BAND 850 + BAND 1850-2170 MHz								
Frequency	HBW	VBW	Gain (dbi)	Polarization	Tilt	Height mm (in)	Model	Page
824 - 896	65°	15°	14	± 45°	Variable 0°- 10°	1340 (53)	TGAD3-400TV	85
1850 - 1990		6°	17.5		Variable 0°- 10°			
1920 - 2170		17.5						
824 - 896	65°	10°	15	± 45°	Variable 0°- 10°	1990 (78)	TGAD3-600TV	86
1850 - 1990		6°	17.2		Variable 0°- 10°			
1920 - 2170		17						
824 - 896	65°	6°	16.3	± 45°	Variable 0°- 8°	2600 (102)	TGAD3-800TV	87
1850 - 1990		6°	17.2		Variable 0°- 10°			
1920 - 2170		17.1						
824 - 896	65°	6°	16	± 45°	Variable 0°- 8°	2530 (100)	TGAND3-800TV	88
1850 - 1990		6°	17		Variable 0°- 10°			
1920 - 2170		17.2						
BAND 850 + BROADBAND 1710-2170 MHz								
824 - 896	65°	15°	14	± 45°	Variable 0°- 10°	1340 (53)	TGAD3-400TV-EX	89
1710 - 1880		17.6			Variable 0°- 10°			
1850 - 1990		6°	17.5					
1920 - 2170		17.5						
824 - 896	65°	10°	15	± 45°	Variable 0°- 10°	1990 (78)	TGAD3-600TV-EX	90
1710 - 1880		17.2			Variable 0°- 10°			
1850 - 1990		6°	17.2					
1920 - 2170		17						
824 - 896	65°	6°	16.3	± 45°	Variable 0°- 8°	2600 (102)	TGAD3-800TV-EX	91
1710 - 1880		17.5			Variable 0°- 10°			
1850 - 1990		6°	17.2					
1920 - 2170		17.1						
824 - 896	65°	6°	16	± 45°	Variable 0°- 8°	2530 (100)	TGAND3-800TV-EX	92
1710 - 1880		17			Variable 0°- 10°			
1850 - 1990		6°	17					
1920 - 2170		17.2						
BAND 900 + BROADBAND 1710 - 2170 MHz								
870 - 960	65°	10°	15.5	± 45°	Variable 0°- 10°	2000 (79)	TGD3-600TV	93
1710 - 1880		6°	17.2		Variable 2°- 10°			
1850 - 1990		6°	17.3					
1920 - 2170		6°	17.5					
870 - 960	65°	6°	16.6	± 45°	Variable 2°- 10°	2615 (103)	TGD3-800TV	94
1710 - 1880		6°	17.3		Variable 2°- 10°			
1850 - 1990		6°	17.5					
1920 - 2170		6°	17.5					

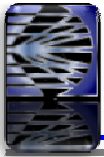

MULTI-BAND PANEL ANTENNA

BAND 850 + BAND 1850-2170 MHZ

TGAD3-400TV

824 - 896	1850 - 2170	
824 - 896	1850-1990	1920-2170
H69° V14.5°	H64° V6.6°	H63° V6.4°
Variable Tilt 0° - 10°	Variable Tilt 0° - 10°	Variable Tilt 0° - 10°

ELECTRICAL SPECIFICATIONS

BAND 850

BAND 1850-2170 MHz

Antenna Model	TGAD3-400TV								
Polarization	± 45°								
Frequency	824-896			1850-2170 MHz					
	824 - 896	1850 - 1990	1920 - 2170						
Horizontal Beamwidth	69°			64°			63°		
Vertical Beamwidth	14.5°			6.6°			6.4°		
Gain (dBi)	T0	T5	T10	T0	T5	T10	T0	T5	T10
	14	14	14	17	17.5	17	17.5	17.5	16.6
Vertical Electrical Tilt	VARIABLE 0°-10°			VARIABLE 0°-10°			VARIABLE 0°-10°		
	T0	T5	T10	T0	T5	T10	T0	T5	T10
Upper Sidelobe Suppression for the 1 st lobe above main beam (dB)	19	19	19	19	19	17	19	19	17
Front-to-Back Ratio @ 180° ± 20° (dB)	> 28			> 26			> 26		
VSWR	< 1.5 : 1			< 1.5 : 1			< 1.5 : 1		
Cross Polar Ratio @ ± 60° (dB) <i>Typically</i>	> 10			> 10			> 8		
Isolation between Ports (dB)	> 30			> 30			> 30		
Interband Isolation (dB)	> 40 (824-896//1850-2170)								
Maximum Power Per Input (W)	500			250					
Intermodulation (dBc)	< - 150								
Impedance (Ω)	50								



MECHANICAL SPECIFICATIONS

Connectors	4 X 7/16 Female
Connector Position	Bottom
Survival Wind Speed	km/h (mph)
	200 (125)
Front Windload	
N @ 160 km/h	(lbs @ 100 mph)
	690 (155)
Lateral Windload	
N @ 160 km/h	(lbs @ 100 mph)
	165 (37)
Radome Color	Grey, paintable
Humidity	100%
Antenna Weight	kg (lbs)
	22 (50)
Antenna Dimension	
mm (in) H X W X D	1340 x 350 x 140 (53 X 14 X 3)

H&V Pattern/ Low band

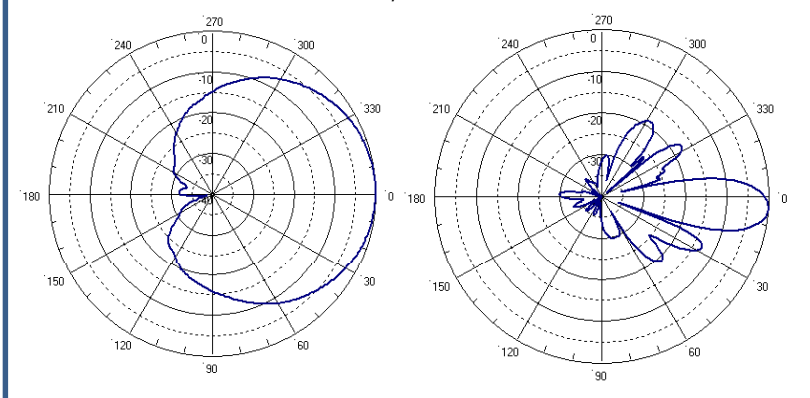

H&V Pattern/ Broadband

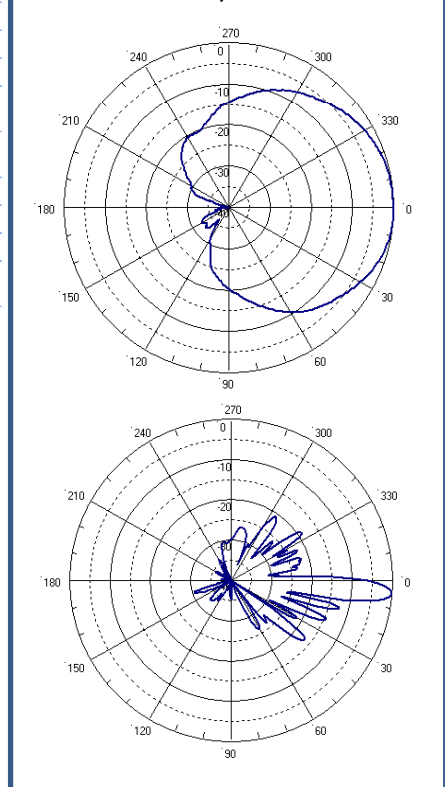

RYMSA Telecom Group (Headquarters)
 Ctra. Campo Real, km. 2.100
 28500 Arganda del Rey (Madrid)-Spain
 Phone : + 34 91 876 06 80
 Fax : + 34 91 875 75 32
 telecom.commercial@rymsa.com



RYMSA México: telecom.commercial@rymsa.com
 Phone: + 52 55 1106 2623
 RYMSA Wireless U.S.A: sales@rymsawireless.com
 Phone: + 1 888 622 6095
 www.rymsawireless.com

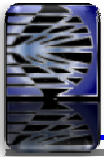

MULTI-BAND PANEL ANTENNA

BAND 850 + BAND 1850-2170 MHZ

TGAD3-600TV

ELECTRICAL SPECIFICATIONS

BAND 850

BAND 1850-2170 MHz

Antenna Model	TGAD3-600TV					
Polarization	± 45°					
Frequency	824-896			1850-2170 MHz		
	824 - 896	1850 - 1990	1920 - 2170			
Horizontal Beamwidth	67°	64°	63°			
Vertical Beamwidth	11°	6.6°	6.4°			
Gain (dBi)	T0	T5	T10	T0	T5	T10
	15	15	14.6	17.1	17.2	16.7
Vertical Electrical Tilt	VARIABLE			VARIABLE		
	0°-10°			0°-10°		
Upper Sidelobe Suppression for the 1 st lobe above main beam (dB)	T0	T5	T10	T0	T5	T10
	18	17	16	19	19	17
Front-to-Back Ratio 180° @ ± 20° (dB)	> 28			> 29		
VSWR	< 1.5 : 1			< 1.5 : 1		
Cross Polar Ratio @ ± 60° (dB) <i>Typically</i>	> 8			> 10		
Isolation between Ports (dB)	> 30			> 30		
Interband Isolation (dB)	> 40 (824-896//1850-2170)					
Maximum Power Per Input (W)	500			250		
Intermodulation (dBc)	< - 150					
Impedance (Ω)	50					

824 - 896	1850 - 2170	
824 - 896	1850-1990	1920-2170
H67° V11°	H64° V6.6°	H63° V6.4°
Variable Tilt 0° - 10°	Variable Tilt 0° - 10°	Variable Tilt 0° - 10°



MECHANICAL SPECIFICATIONS

Connectors	4 X 7/16 Female
Connector Position	Bottom
Survival Wind Speed	km/h (mph)
	200 (125)
Front Windload	
N @ 160 km/h	(lbs @ 100 mph)
	1050 (236)
Lateral Windload	
N @ 160 km/h	(lbs @ 100 mph)
	260 (60)
Radome Color	Grey, paintable
Humidity	100%
Antenna Weight	kg (lbs)
	28 (62)
Antenna Dimension	
mm (in) H X W X D	1990 x 350 x 150 (78 X 14 X 6)

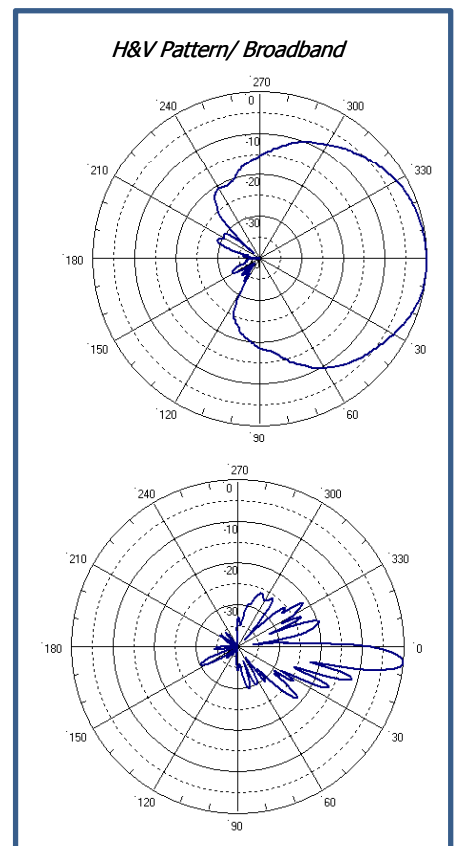
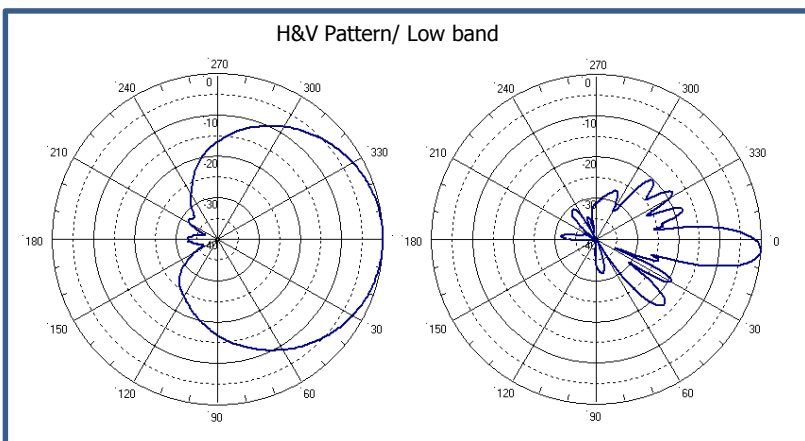

RYMSA Telecom Group (Headquarters)
 Crtra. Campo Real, km. 2.100
 28500 Arganda del Rey (Madrid)-Spain
 Phone : + 34 91 876 06 80
 Fax : + 34 91 875 75 32
 telecom.commercial@rymsa.com



RYMSA México: telecom.commercial@rymsa.com
 Phone: + 52 55 1106 2623
 RYMSA Wireless U.S.A: sales@rymsawireless.com
 Phone: + 1 888 622 6095
 www.rymsawireless.com

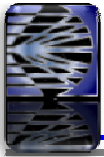

MULTI-BAND PANEL ANTENNA

BAND 850 + BAND 1850-2170 MHZ

TGAD3-800TV

ELECTRICAL SPECIFICATIONS

BAND 850

BAND 1850-2170 MHz

Antenna Model	TGAD3-800TV								
Polarization	± 45°								
Frequency	824-896			1850-2170 MHz					
	824 - 896	1850 - 1990	1920 - 2170						
Horizontal Beamwidth	65°			64°			63°		
Vertical Beamwidth	7.9°			6.6°			6.4°		
Gain (dBi)	T0	T4	T8	T0	T5	T10	T0	T5	T10
	16.5	16.3	16.1	17	17.2	16.7	17.5	17.1	16.5
Vertical Electrical Tilt	VARIABLE			VARIABLE			VARIABLE		
	0°-8°			0°-10°			0°-10°		
Upper Sidelobe Suppression for the 1 st lobe above main beam (dB)	T0	T4	T8	T0	T5	T10	T0	T5	T10
	16	15	15	19	19	17	17	17	17
Front-to-Back Ratio @ 180° ± 20° (dB)	> 28			> 28			> 28		
VSWR	< 1.5 : 1			< 1.5 : 1			< 1.5 : 1		
Cross Polar Ratio @ ± 60° (dB) <i>Typically</i>	> 10			> 10			> 10		
Isolation between Ports (dB)	> 30			> 30			> 30		
Interband Isolation (dB)	> 40 (824-896//1850-2170)								
Maximum Power Per Input (W)	500			250					
Intermodulation (dBc)	< - 150								
Impedance (Ω)	50								

824 - 896	1850 - 2170	
824 - 896	1850-1990	1920-2170
H69° V7.9°	H69° V6.1°	H67° V6°
Variable Tilt 0° - 8°	Variable Tilt 0° - 10°	Variable Tilt 0° - 10°



MECHANICAL SPECIFICATIONS

Connectors	4 X 7/16 Female	
Connector Position	Bottom	
Survival Wind Speed	km/h (mph)	200 (125)
Front Windload	1400 (315)	
N @ 160 km/h	(lbs @ 100 mph)	
Lateral Windload	350 (79)	
N @ 160 km/h	(lbs @ 100 mph)	
Radome Color	Grey, paintable	
Humidity	100%	
Antenna Weight	kg (lbs)	34 (75)
Antenna Dimension	2600 x 350 x 150 (102 X 14 X 6)	
mm (in) H X W X D		

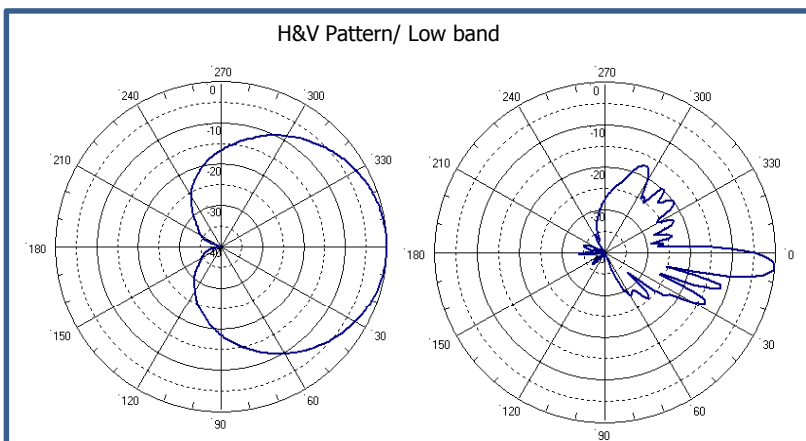
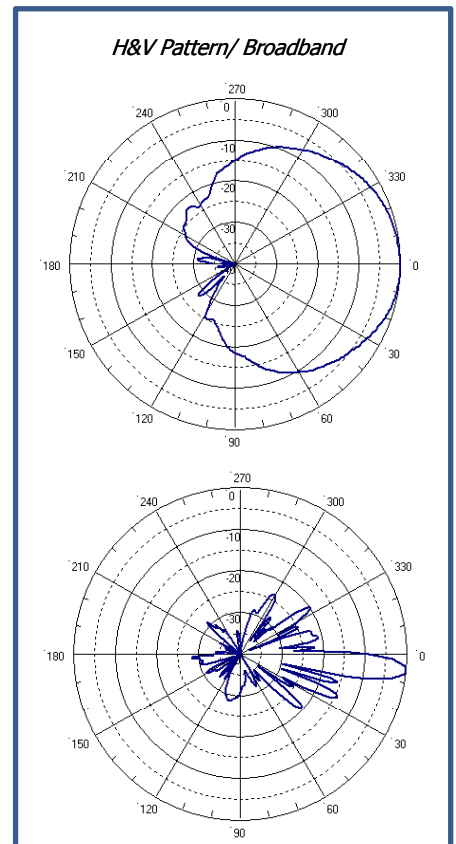

RYMSA Telecom Group (Headquarters)
 Ctra. Campo Real, km. 2,100
 28500 Arganda del Rey (Madrid)-Spain
 Phone : + 34 91 876 06 80
 Fax : + 34 91 875 75 32
 telecom.commercial@rymsa.com



RYMSA México: telecom.commercial@rymsa.com
 Phone: + 52 55 1106 2623
 RYMSA Wireless U.S.A: sales@rymsawireless.com
 Phone: + 1 888 622 6095
 www.rymsawireless.com

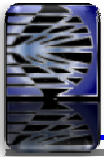

MULTI-BAND PANEL ANTENNA

BAND 850 + BAND 1850-2170 MHZ

TGAND3-800TV

ELECTRICAL SPECIFICATIONS

BAND 850

BAND 1850-2170 MHz

Antenna Model	TGAND3-800TV								
Polarization	± 45°								
Frequency	824-896			1850-2170 MHz					
	824 - 896	1850 - 1990	1920 - 2170						
Horizontal Beamwidth	69°	69°	67°						
Vertical Beamwidth	7.9°	6.1°	6°						
Gain (dBi)	T0 T4 T8	T0 T5 T10	T0 T5 T10						
	15.7 16 15.6	17 17 16.6	17 17.2 17						
Vertical Electrical Tilt	VARIABLE 0°-8°			VARIABLE 0°-10°			VARIABLE 0°-10°		
Upper Sidelobe Suppression for the 1 st lobe above main beam (dB)	T0 T4 T8	T0 T5 T10	T0 T5 T10						
	16 15 14	19 17 17	19 17 17						
Front-to-Back Ratio @ 180°± 20° (dB)	> 10			> 8			> 8		
VSWR	< 1.5 : 1			< 1.5 : 1			< 1.5 : 1		
Cross Polar Ratio @ ± 60° (dB)	> 10			> 10			> 10		
Isolation between Ports (dB)	> 30			> 30			> 30		
Interband Isolation (dB)	> 40 (824-896//1850-2170)								
Maximum Power Per Input (W)	500			250					
Intermodulation (dBc)	< - 150								
Impedance (Ω)	50								

824 - 896	1850 - 2170	
824 - 896	1850-1990	1920-2170
H69° V7.9°	H69° V6.1°	H67° V6°
Variable Tilt 0° - 8°	Variable Tilt 0° - 10°	Variable Tilt 0° - 10°



MECHANICAL SPECIFICATIONS

Connectors	4 X 7/16 Female	
Connector Position	Bottom	
Survival Wind Speed	km/h (mph)	200 (125)
Front Windload	1210 (272)	
N @ 160 km/h	(lbs @ 100 mph)	
Lateral Windload	200 (45)	
N @ 160 km/h	(lbs @ 100 mph)	
Radome Color	Grey, paintable	
Humidity	100%	
Antenna Weight	kg (lbs)	28 (62)
Antenna Dimension	2530 X 325 X 115 (100 X 13 X 5)	
mm (in) H X W X D		

H&V Pattern/ Broadband

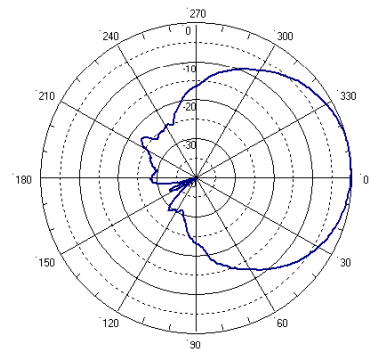

H&V Pattern/ Low band

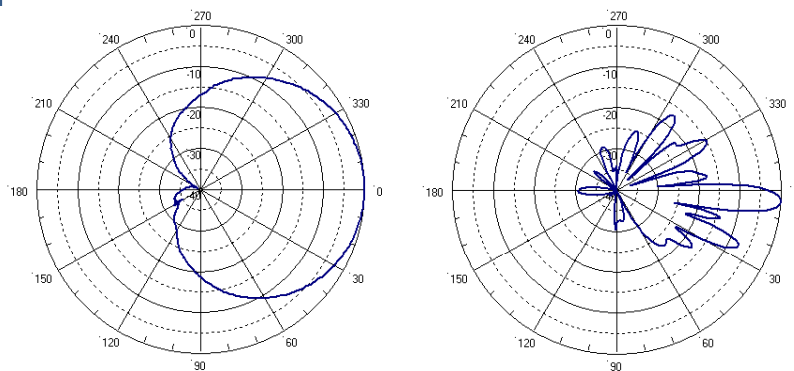

RYMSA Telecom Group (Headquarters)
 Crtra. Campo Real, km. 2.100
 28500 Arganda del Rey (Madrid)-Spain
 Phone : + 34 91 876 06 80
 Fax : + 34 91 875 75 32
 telecom.commercial@rymsa.com



RYMSA México: telecom.commercial@rymsa.com
 Phone: + 52 55 1106 2623
 RYMSA Wireless U.S.A: sales@rymsawireless.com
 Phone: + 1 888 622 6095
 www.rymsawireless.com

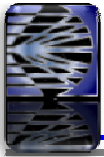

MULTI-BAND PANEL ANTENNA

2 X BAND 850 + 2 X BROADBAND 1710 - 2170 MHZ

TGAD3-400TV-EX

824 - 896	1710 - 2170		
824 - 896	1710 - 1880	1850 - 1990	1920 - 2170
H69° V14.5°	H65° V6.6°	H64° V6.6°	H63° V6.4°
Variable Tilt 0° - 10°	Variable Tilt 0° - 10°	Variable Tilt 0° - 10°	Variable Tilt 0° - 10°

ELECTRICAL SPECIFICATIONS

2 X BAND 850

2 X BROADBAND 1710-2170 MHZ

Antenna Model	TGAD3-400TV-EX			
Polarization	± 45°			
Frequency	2 X (824-896)		2 X (1710-2170)	
	824 - 896	1710 - 1880	1850 - 1990	1920 - 2170
Horizontal Beamwidth	69°	65°	64°	63°
Vertical Beamwidth	14.5°	6.6°	6.6°	6.4°
Gain (dBi)	T0 T5 T10	T0 T5 T10	T0 T5 T10	T0 T5 T10
	14 14 14	17.2 17.6 17.5	17 17.5 17	17.5 17.5 16.6
Vertical Electrical Tilt	VARIABLE 0°-10°		VARIABLE 0°-10°	
Upper Sidelobe Suppression for the 1 st lobe above main beam (dB)	T0 T5 T10	T0 T5 T10	T0 T5 T10	T0 T5 T10
	19 19 19	19 17 17	19 19 17	19 19 17
Front-to-Back Ratio @ 180° ± 20° (dB)	> 28	> 26	> 26	> 26
VSWR	< 1.5 : 1	< 1.5 : 1	< 1.5 : 1	< 1.5 : 1
Cross Polar Ratio @ ± 60° (dB) <i>Typically</i>	> 10	> 10	> 10	> 8
Isolation between Ports (dB)	> 30	> 30	> 30	> 30
Interband Isolation (dB)	> 40 (824-896//1710-2170)			
Maximum Power Per Input (W)	500		250	
Intermodulation (dBc)	< - 150			
Impedance (Ω)	50			



MECHANICAL SPECIFICATIONS

Connectors	4 X 7/16 Female
Connector Position	Bottom
Survival Wind Speed km/h (mph)	200 (125)
Front Windload N @ 160 km/h (lbs @ 100 mph)	690 (155)
Lateral Windload N @ 160 km/h (lbs @ 100 mph)	165 (37)
Radome Color	Grey, paintable
Humidity	100%
Antenna Weight kg (lbs)	22 (48)
Antenna Dimension mm (in) H X W X D	1340 x 350 x 140 (53 X 14 X 3)

H&V Pattern/ Low band

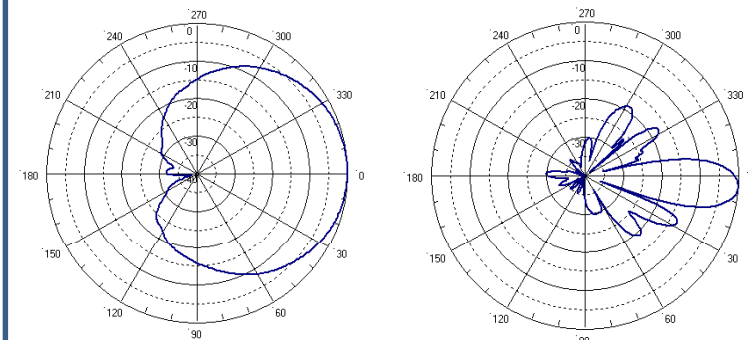

H&V Pattern/ Broadband

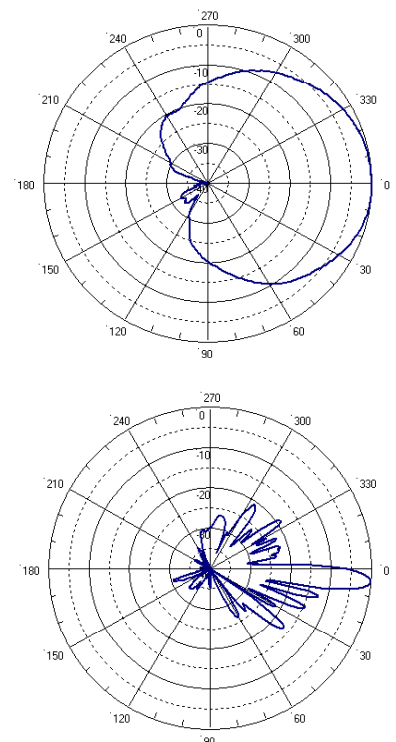

RYMSA Telecom Group (Headquarters)
 Ctra. Campo Real, km. 2.100
 28500 Arganda del Rey (Madrid)-Spain
 Phone : + 34 91 876 06 80
 Fax : + 34 91 875 75 32
 telecom.commercial@rymsa.com



RYMSA México: telecom.commercial@rymsa.com
 Phone: + 52 55 1106 2623
 RYMSA Wireless U.S.A: sales@rymsawireless.com
 Phone: + 1 888 622 6095
 www.rymsawireless.com



MULTI-BAND PANEL ANTENNA

2 X BAND 850 + 2 X BROADBAND 1710 - 2170 MHZ

TGAD3-600TV-EX

824 - 896	1710 - 2170		
824 - 896	1710-1880	1850-1990	1920-2170
H67° V11°	H65° V6.6°	H64° V6.6°	H63° V6.4°
Variable Tilt 0° - 10°	Variable Tilt 0° - 10°	Variable Tilt 0° - 10°	Variable Tilt 0° - 10°

ELECTRICAL SPECIFICATIONS

2 X BAND 850

2 X BROADBAND 1710-2170 MHz

Antenna Model	TGAD3-600TV-EX			
Polarization	± 45°			
Frequency	2 X (824-896)		2 X (1710-2170)	
	824 - 896	1710 - 1880	1850 - 1990	1920 - 2170
Horizontal Beamwidth	67°	65°	64°	63°
Vertical Beamwidth	11°	6.6°	6.6°	6.4°
Gain (dBi)	T0 T5 T10 15 15 14.6	T0 T5 T10 17.2 17.2 17	T0 T5 T10 17.1 17.2 16.7	T0 T4 T8 17.5 17 16.5
Vertical Electrical Tilt	VARIABLE 0°-10°	VARIABLE 0°-10°	VARIABLE 0°-10°	VARIABLE 0°-10°
Upper Sidelobe Suppression for the 1 st lobe above main beam (dB)	T0 T5 T10 18 17 16	T0 T5 T10 20 17 17	T0 T5 T10 19 19 17	T0 T5 T10 17 17 17
Front-to-Back Ratio @ 180° ± 20° (dB)	> 28	> 25	> 26	> 26
VSWR	< 1.5 : 1	< 1.5 : 1	< 1.5 : 1	< 1.5 : 1
Cross Polar Ratio @ ± 60° (dB) <i>Typically</i>	> 8	> 10	> 10	> 8
Isolation between Ports (dB)	> 30	> 30	> 30	> 30
Interband Isolation (dB)	> 40 (824-896//1710-2170)			
Maximum Power Per Input (W)	500	250		
Intermodulation (dBC)	< - 150			
Impedance (Ω)	50			

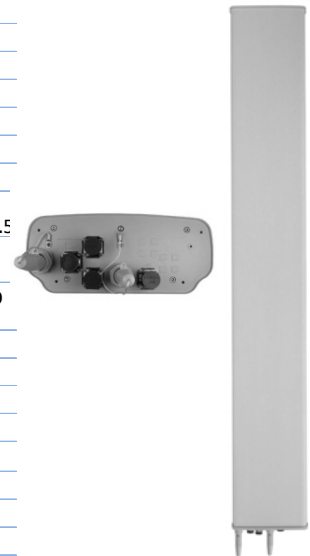

MECHANICAL SPECIFICATIONS

Connectors	4 X 7/16 Female
Connector Position	Bottom
Survival Wind Speed km/h (mph)	200 (125)
Front Windload N @ 160 km/h (lbs @ 100 mph)	1050 (236)
Lateral Windload N @ 160 km/h (lbs @ 100 mph)	260 (60)
Radome Color	Grey, paintable
Humidity	100%
Antenna Weight kg (lbs)	28 (62)
Antenna Dimension mm (in) H X W X D	1990 x 350 x 150 (78 X 14 X 6)

H&V Pattern/ Low band

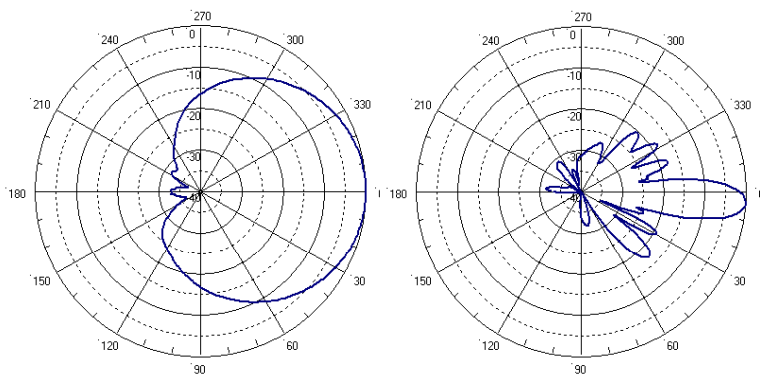

H&V Pattern/ Broadband

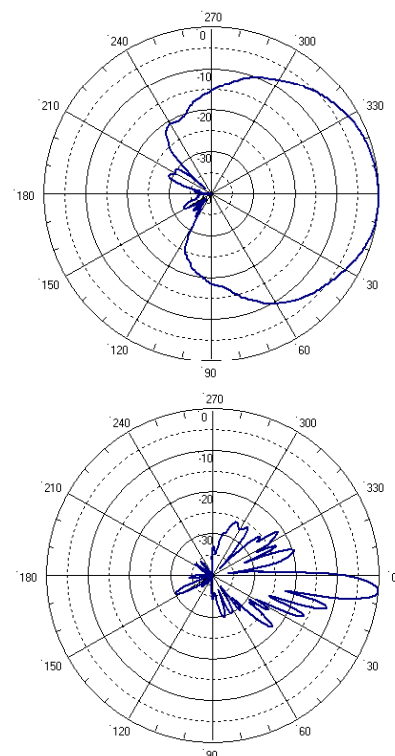

RYMSA Telecom Group (Headquarters)
 Ctra. Campo Real, km. 2.100
 28500 Arganda del Rey (Madrid)-Spain
 Phone : + 34 91 876 06 80
 Fax : + 34 91 875 75 32
 telecom.commercial@rymsa.com



RYMSA México: telecom.commercial@rymsa.com
 Phone: + 52 55 1106 2623
 RYMSA Wireless U.S.A: sales@rymsawireless.com
 Phone: + 1 888 622 6095
 www.rymsawireless.com

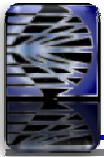

MULTI-BAND PANEL ANTENNA

2 X BAND 850 + 2 X BROADBAND 1710 - 2170 MHZ

TGAD3-800TV-EX

824 - 896	1710 - 2170		
824 - 896	1710 - 1880	1850-1990	1920-2170
H65° V7.9°	H65° V6.6°	H64° V6.6°	H63° V6.4°
Variable Tilt 0° - 8°	Variable Tilt 0° - 10°	Variable Tilt 0° - 10°	Variable Tilt 0° - 10°

ELECTRICAL SPECIFICATIONS

2 X BAND 850

2 X BROADBAND 1710-2170 MHZ

Antenna Model	TGAD3-800TV-EX			
Polarization	± 45°			
Frequency	2 X (824-896)		2 X (1710-2170)	
	824 - 896	1710 - 1880	1850 - 1990	1920 - 2170
Horizontal Beamwidth	65°	65°	64°	63°
Vertical Beamwidth	7.9°	6.6°	6.6°	6.4°
Gain (dBi)	T0 T4 T8 16.5 16.3 16.1	T0 T5 T10 17.5 17.5 17.1	T0 T5 T10 17.1 17.2 16.7	T0 T5 T10 17.5 17.1 16.5
Vertical Electrical Tilt	VARIABLE 0°-8°	VARIABLE 0°-10°	VARIABLE 0°-10°	VARIABLE 0°-10°
Upper Sidelobe Suppression for the 1 st lobe above main beam (dB)	T0 T4 T8 16 15 15	T0 T5 T10 19 17 17	T0 T5 T10 19 19 17	T0 T5 T10 17 17 17
Front-to-Back Ratio 180° @ ± 20° (dB)	> 28	> 25	> 26	> 26
VSWR	< 1.5 : 1	< 1.5 : 1	< 1.5 : 1	< 1.5 : 1
Cross Polar Ratio @ ± 60° (dB)	> 10	> 10	> 10	> 8
Isolation between Ports (dB)	> 30	> 30	> 30	> 30
Interband Isolation (dB)	> 40 (824-896//1710-2170)			
Maximum Power Per Input (W)	500	250		
Intermodulation (dBc)	< - 150			
Impedance (Ω)	50			



MECHANICAL SPECIFICATIONS

Connectors	4 X 7/16 Female
Connector Position	Bottom
Survival Wind Speed km/h (mph)	200 (125)
Front Windload N @ 160 km/h (lbs @ 100 mph)	1400 (315)
Lateral Windload N @ 160 km/h (lbs @ 100 mph)	350 (79)
Radome Color	Grey, paintable
Humidity	100%
Antenna Weight kg (lbs)	34 (75)
Antenna Dimension mm (in) H X W X D	2600 x 350 x 150 (102 X 14 X 6)

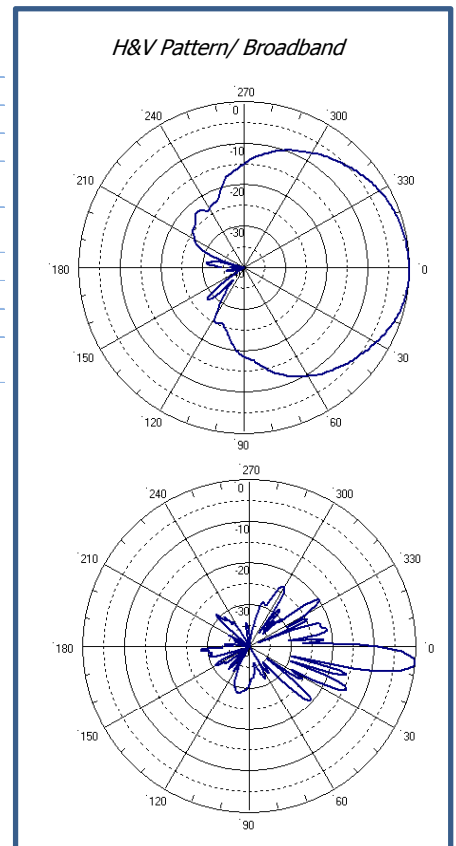
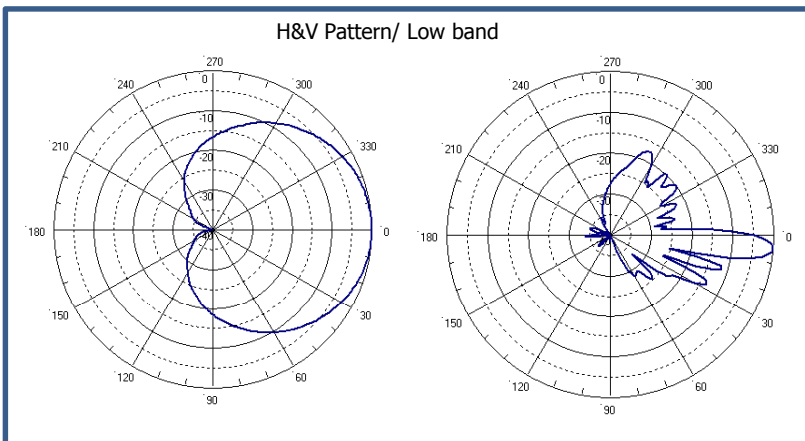

RYMSA Telecom Group (Headquarters)
 Crtra. Campo Real, km. 2.100
 28500 Arganda del Rey (Madrid)-Spain
 Phone : + 34 91 876 06 80
 Fax : + 34 91 875 75 32
 telecom.commercial@rymsa.com



RYMSA México: telecom.commercial@rymsa.com
 Phone: + 52 55 1106 2623
 RYMSA Wireless U.S.A: sales@rymsawireless.com
 Phone: + 1 888 622 6095
 www.rymsawireless.com

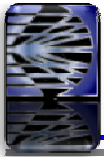

MULTI-BAND PANEL ANTENNA

2 X BAND 850 + 2 X BROADBAND 1710 - 2170 MHZ

824 - 896	1710 - 2170		
824 - 896	1710 - 1880	1850-1990	1920-2170
H69° V7.9°	H69° V6.2°	H69° V6.1°	H67° V6°
Variable Tilt 0° - 8°	Variable Tilt 0° - 10°	Variable Tilt 0° - 10°	Variable Tilt 0° - 10°

TGAND3-800TV-EX

ELECTRICAL SPECIFICATIONS

2 X BAND 850

2 X BROADBAND 1710-2170 MHz

Antenna Model	TGAND3-800TV-EX			
Polarization	± 45°			
Frequency	2 X (824-896)		2 X (1710-2170)	
	824 - 896	1710 - 1880	1850 - 1990	1920 - 2170
Horizontal Beamwidth	69°	69°	69°	67°
Vertical Beamwidth	7.9°	6.2°	6.1°	6°
Gain (dBi)	T0 T4 T8 15.7 16 15.6	T0 T5 T10 16.6 17 16.7	T0 T5 T10 17 17 16.6	T0 T5 T10 17 17.2 17
Vertical Electrical Tilt	VARIABLE 0°-8°	VARIABLE 0°-10°	VARIABLE 0°-10°	VARIABLE 0°-10°
Upper Sidelobe Suppression for the 1 st lobe above main beam (dB)	T0 T4 T8 16 15 14	T0 T5 T10 19 19 17	T0 T5 T10 19 17 17	T0 T5 T10 19 17 17
Front-to-Back Ratio @ 180° ± 20° (dB)	> 30	> 30	> 30	> 30
VSWR	< 1.5 : 1	< 1.5 : 1	< 1.5 : 1	< 1.5 : 1
Cross Polar Ratio @ ± 60° (dB) <i>Typically</i>	> 10	> 10	> 8	> 8
Isolation between Ports (dB)	> 30	> 30	> 30	> 30
Interband Isolation (dB)	> 35 (824-896//1710-2170)			
Maximum Power Per Input (W)	500	250		
Intermodulation (dBc)	< - 150			
Impedance (Ω)	50			



MECHANICAL SPECIFICATIONS

Connectors	4 X 7/16 Female
Connector Position	Bottom
Survival Wind Speed km/h (mph)	200 (125)
Front Windload N @ 160 km/h (lbs @ 100 mph)	1210 (272)
Lateral Windload N @ 160 km/h (lbs @ 100 mph)	200 (45)
Radome Color	Grey, paintable
Humidity	100%
Antenna Weight kg (lbs)	28 (62)
Antenna Dimension mm (in) H X W X D	2530 X 325 X 115 (100 X 13 X 5)

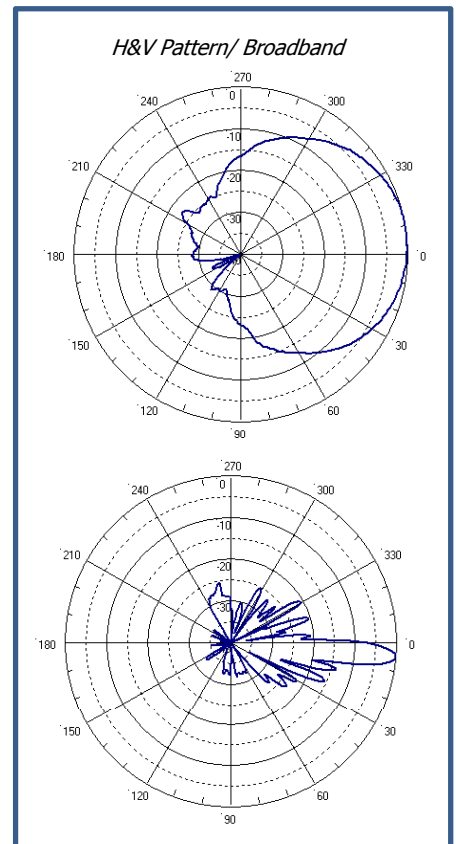
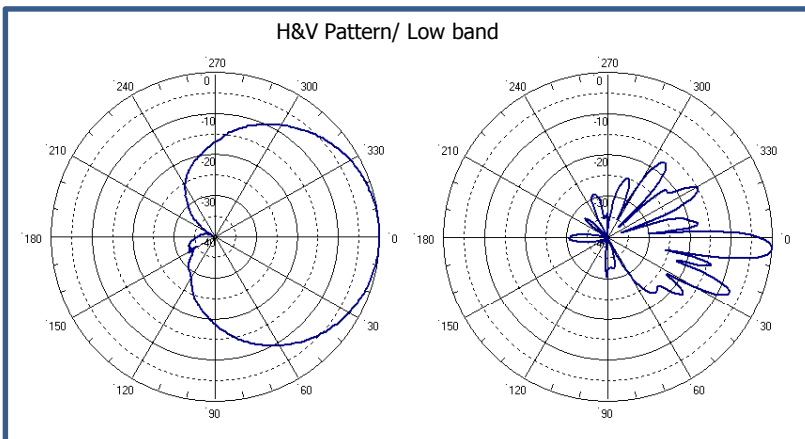

RYMSA Telecom Group (Headquarters)
 Crtra. Campo Real, km. 2.100
 28500 Arganda del Rey (Madrid)-Spain
 Phone : + 34 91 876 06 80
 Fax : + 34 91 875 75 32
 telecom.commercial@rymsa.com



RYMSA México: telecom.commercial@rymsa.com
 Phone: + 52 55 1106 2623
 RYMSA Wireless U.S.A: sales@rymsawireless.com
 Phone: + 1 888 622 6095
 www.rymsawireless.com

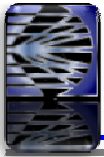

MULTI-BAND PANEL ANTENNA

BAND 900 + BROADBAND 1710-2170 MHZ

TGD3-600TV

870 - 960	1710 - 2170		
870 - 960	1710-1880	1850 - 1990	1920-2170
H61° V11°	H67° V7°	H64° V6.5°	H60° V6.2°
Variable Tilt 0° - 10°	Variable Tilt 2° - 10°	Variable Tilt 2° - 10°	Variable Tilt 2° - 10°

ELECTRICAL SPECIFICATIONS

BAND 900

BROADBAND 1710-2170 MHz

Antenna Model	TGD3-600TV			
Polarization	± 45°			
Frequency	870 - 960	1710 - 2170		
	870 - 960	1710 - 1880	1850 - 1990	1920 - 2170
Horizontal Beamwidth	61°	67°	64°	60°
Vertical Beamwidth	11°	7°	6.5°	6.2°
Gain (dBi)	15.5	17.2	17.3	17.5
Vertical Electrical Tilt	VARIABLE 0°-10°	VARIABLE 2°-10°	VARIABLE 2°-10°	VARIABLE 2°-10°
Upper Sidelobe Suppression for the 1 st lobe above main beam (dB)	T0 T5 T10 14 16 15	T2 T5 T10 18 18 15	T2 T5 T10 20 18 18	T2 T5 T10 18 18 15
Front-to-Back Ratio @ 180° ± 20° (dB)	> 25	> 25	> 25	> 25
VSWR	< 1.5 : 1	< 1.5 : 1	< 1.5 : 1	< 1.5 : 1
Cross Polar Ratio @ - 3dB Beamwidth Typically (dB)	> 15	> 15	> 15	> 15
Isolation between Ports (dB)	> 30	> 30	> 30	> 30
Interband Isolation (dB)	> 40 (870-960//1710-2170)			
Maximum Power Per Input (W)	500	250		
Intermodulation (dBc)	< - 150			
Impedance (Ω)	50			

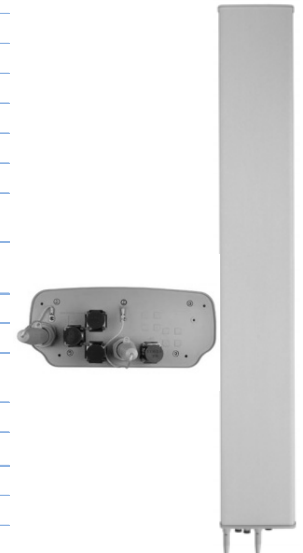

MECHANICAL SPECIFICATIONS

Connectors	4 X 7/16 Female
Connector Position	Bottom
Survival Wind Speed km/h (mph)	200 (125)
Front Windload N @ 160 km/h (lbs @ 100 mph)	1040 (234)
Lateral Windload N @ 160 km/h (lbs @ 100 mph)	240 (54)
Radome Color	Grey, paintable
Humidity	100%
Antenna Weight kg (lbs)	30 (66)
Antenna Dimension mm (in) H X W X D	2000 X 345 X 145 (79 X 14 X 6)

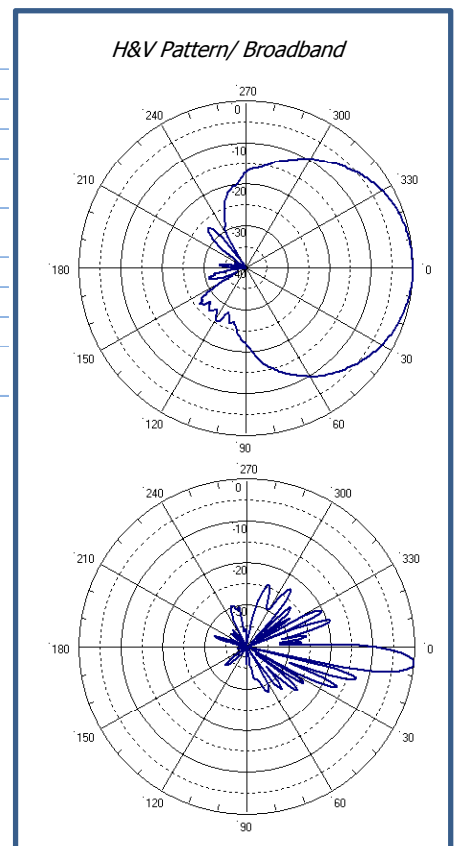
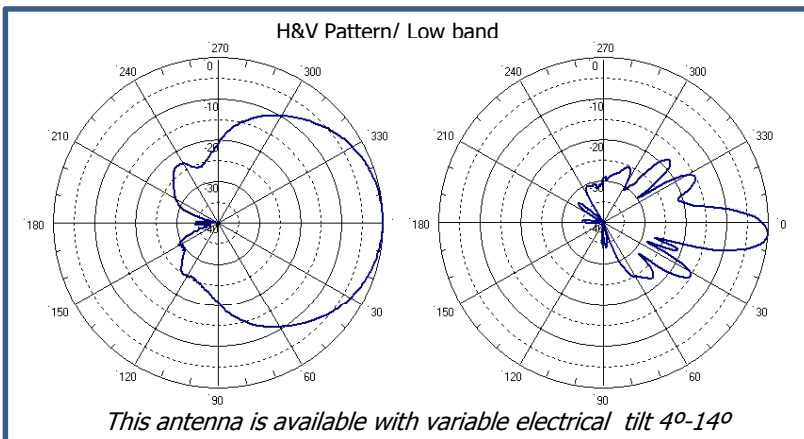

RYMSA Telecom Group (Headquarters)
 Crtra. Campo Real, km. 2.100
 28500 Arganda del Rey (Madrid)-Spain
 Phone : + 34 91 876 06 80
 Fax : + 34 91 875 75 32
 telecom.commercial@rymsa.com



RYMSA México: telecom.commercial@rymsa.com
 Phone: + 52 55 1106 2623
 RYMSA Wireless U.S.A: sales@rymsawireless.com
 Phone: + 1 888 622 6095
 www.rymsawireless.com

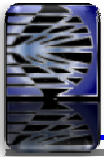

MULTI-BAND PANEL ANTENNA

BAND 900 + BROADBAND 1710-2170 MHZ

TGD3-800TV

870 - 960	1710 - 2170		
870 - 960	1710-1880	1850-1990	1920-2170
H60° V7.5°	H67° V6.8°	H65° V6.5°	H60° V6.3°
Variable Tilt 2° - 10°	Variable Tilt 2° - 10°	Variable Tilt 2° - 10°	Variable Tilt 2° - 10°

ELECTRICAL SPECIFICATIONS

BAND 900

BROADBAND 1710-2170 MHZ

Antenna Model	TGD3-800TV			
Polarization	± 45°			
Frequency	870 - 960		1710 - 2170	
	870 - 960	1710-1880	1850-1990	1920-2170
Horizontal Beamwidth	60°	67°	65°	60°
Vertical Beamwidth	7.5°	6.8°	6.5°	6.3°
Gain (dBi)	16.6	17.3	17.4	17.5
Vertical Electrical Tilt	VARIABLE 2°-10°	VARIABLE 2°-10°	VARIABLE 2°-10°	VARIABLE 2°-10°
Upper Sidelobe Suppression for the 1 st lobe above main beam (dB)	T2 T6 T10 19 20 17	T2 T6 T10 20 17 16	T2 T6 T10 20 20 18	T2 T6 T10 20 18 18
Front-to-Back Ratio @ 180° ± 20° (dB)	> 27	> 25	> 24	> 24
VSWR	< 1.5 : 1	< 1.5 : 1	< 1.5 : 1	< 1.5 : 1
Cross Polar Ratio @ -3°dB Beamwidth <i>Typically</i>	>15	>15	>15	>15
Isolation between Ports (dB)	> 30	> 30	> 30	> 30
Interband Isolation (dB)	> 40 (870-960//1710-2170)			
Maximum Power Per Input (W)	500	250		
Intermodulation (dBc)	< - 150			
Impedance (Ω)	50			



MECHANICAL SPECIFICATIONS

Connectors	4 X 7/16 Female
Connector Position	Bottom
Survival Wind Speed km/h (mph)	200 (125)
Front Windload N @ 160 km/h (lbs @ 100 mph)	1380 (310)
Lateral Windload N @ 160 km/h (lbs @ 100 mph)	330 (74)
Radome Color	Grey, paintable
Humidity	100%
Antenna Weight kg (lbs)	34 (75)
Antenna Dimension mm (in) H X W X D	2615 X 345 X 145 (103 X 14 X 6)

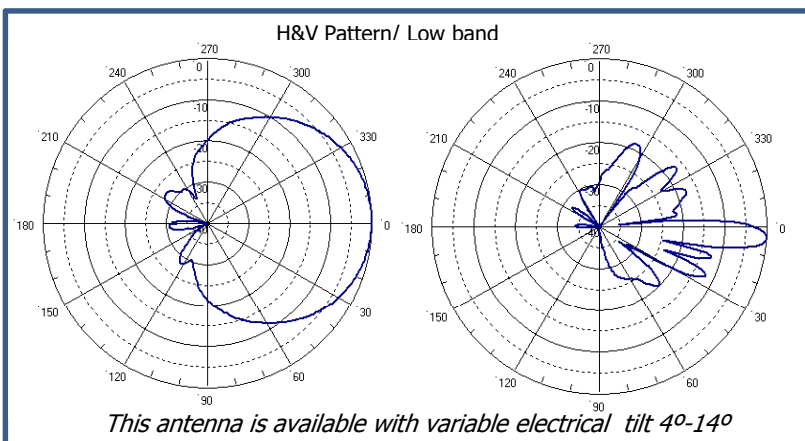
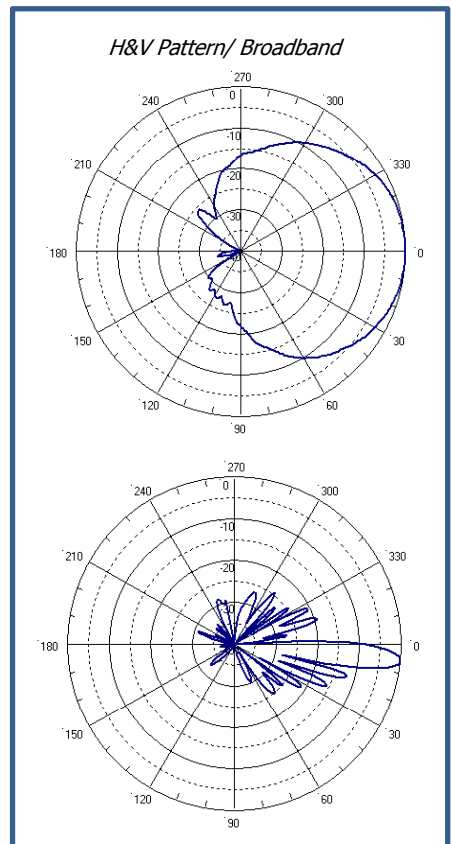

RYMSA Telecom Group (Headquarters)
 Ctra. Campo Real, km. 2.100
 28500 Arganda del Rey (Madrid)-Spain
 Phone : + 34 91 876 06 80
 Fax : + 34 91 875 75 32
 telecom.commercial@rymsa.com



RYMSA México: telecom.commercial@rymsa.com
 Phone: + 52 55 1106 2623
 RYMSA Wireless U.S.A: sales@rymsawireless.com
 Phone: + 1 888 622 6095
 www.rymsawireless.com



MULTI-BAND PANEL ANTENNA

QUAD-BAND

MULTI - BAND PANEL ANTENNA								
QUAD-BAND PANEL ANTENNA								
2 X BAND 850 + 2 X BAND 1850 - 2170 MHz								
Frequency	HBW	VBW	Gain (dbi)	Polarization	Tilt	Height mm (in)	Model	Page
824 - 896	65°	15°	14	± 45°	Variable 0° - 10°	2615 (103)	TGA2D3-800TV	96
1850 - 1990	65°	6°	18	± 45°	Variable 0° - 10°			
1920 - 2170	65°	6°	17.5					
2 X BAND 850 + 2 X BROADBAND 1710 - 2170 MHz								
824 - 896	65°	15°	14	± 45°	Variable 0° - 10°	2615 (103)	TGA2D3-800TV-EX	97
1710 - 1880	65°	6°	17.5	± 45°	Variable 0° - 10°			
1850 - 1990	65°	6°	18					
1920 - 2170	65°	6°	17.5					

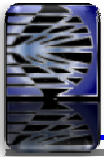

MULTI-BAND PANEL ANTENNA

2 X BAND 850 + 2 X BAND 1850-2170 MHZ

TGA2D3-800TV

2 X 824 - 896	2 X 1850 - 2170	
824 - 896	1850-1990	1920-2170
H69° V14.5°	H64° V6.6°	H63° V6.5°
Variable Tilt 0° - 10°	Variable Tilt 0° - 10°	Variable Tilt 0° - 10°

ELECTRICAL SPECIFICATIONS

2 X BAND 850

2 X BAND 1850-2170 MHz

Antenna Model	TGA2D3-800TV								
Polarization	+/- 45°								
	2 X (824 - 896)			2 X (1850 - 2170)					
Frequency	824 - 896			1850 - 1990			1920 - 2170		
Horizontal Beamwidth	69°			64°			63°		
Vertical Beamwidth	14.5°			6.6°			6.4°		
Gain (dBi)	T0	T5	T10	T0	T5	T10	T0	T5	T10
	13.5	13.5	13.5	16.5	16.5	16	16.5	16.5	16
	14	14	14	17	18	17	17.5	17.5	16
Vertical Electrical Tilt	VARIABLE 0°-10°			VARIABLE 0°-10°			VARIABLE 0°-10°		
Upper Sidelobe Suppression for the 1 st lobe above main beam (dB)	T0	T5	T10	T0	T5	T10	T0	T5	T10
	19	19	19	19	19	17	19	19	17
Front-to-Back Ratio @ 180° ± 20° (dB)	> 28			> 28			> 28		
VSWR	< 1.5 : 1			< 1.5 : 1			< 1.5 : 1		
Cross Polar Ratio @ ± 60° (dB) <i>Typically</i>	> 10			> 10			> 10		
Isolation between Ports (dB)	> 30			> 30			> 30		
Interband Isolation (dB)	> 40 (824-896//1850-2170) > 30 (1850-2170//1850-2170)								
Maximum Power Per Input (W)	500			250					
Intermodulation (dBc)	< - 150								
Impedance (Ω)	50								



MECHANICAL SPECIFICATIONS

Connectors	8 x 7/16 Female	
Connector Position	Bottom	
Survival Wind Speed km/h (mph)	200 (125)	
Front Windload N @ 160 km/h (lbs @ 100 mph)	1410 (317)	
Lateral Windload N @ 160 km/h (lbs @ 100 mph)	350 (79)	
Radome Color	Grey, paintable	
Humidity	100%	
Antenna Weight kg (lbs)	40 (88)	
Antenna Dimension mm (in) H X W X D	2615 X 345 X 145 (103 X 14 X 6)	

H&V Pattern/ Low band

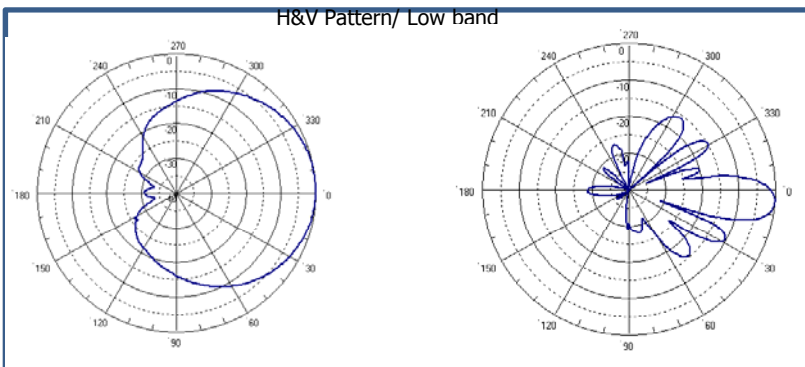

H&V Pattern/ Broadband

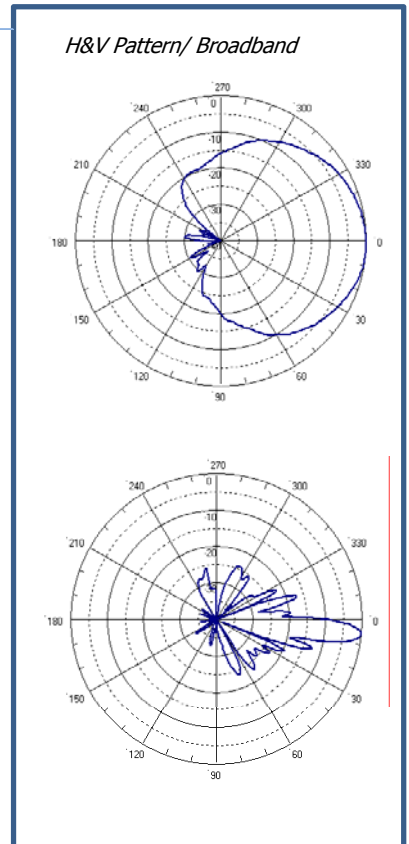

RYMSA Telecom Group (Headquarters)
 Crtra. Campo Real, km. 2,100
 28500 Arganda del Rey (Madrid)-Spain
 Phone : + 34 91 876 06 80
 Fax : + 34 91 875 75 32
 telecom.commercial@rymsa.com



RYMSA México: telecom.commercial@rymsa.com
 Phone: + 52 55 1106 2623
 RYMSA Wireless U.S.A: sales@rymsawireless.com
 Phone: + 1 888 622 6095
 www.rymsawireless.com

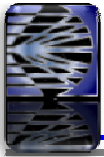

MULTI-BAND PANEL ANTENNA

2 X BAND 850 + 2 X BROADBAND 1710-2170 MHZ

TGA2D3-800TV-EX

2 X 824 - 896		2 X 1710 - 2170	
824 - 896	1710-1880	1850-1990	1920-2170
H69° V14.5°	H65° V6.6°	H64° V6.6°	H63° V6.5°
Variable Tilt 0° - 10°	Variable Tilt 0° - 10°	Variable Tilt 0° - 10°	Variable Tilt 0° - 10°

ELECTRICAL SPECIFICATIONS

2 X BAND 850

2 X BROADBAND 1710-2170 MHz

Antenna Model	TGA2D3-800TV-EX			
Polarization	+/- 45°			
	2 X (824 - 896)		2 X (1710 - 2170)	
Frequency	824 - 896	1710 - 1880	1850 - 1990	1920 - 2170
Horizontal Beamwidth	69°	65°	64°	63°
Vertical Beamwidth	14.5°	6.6°	6.6°	6.5°
Gain (dBi)	TOP		TOP	
	T0 T5 T10	T0 T5 T10	T0 T5 T10	T0 T5 T10
BOTTOM	13.6 13.5 13.3	16.5 16.7 16.6	16.3 16.6 16.1	16.6 16.5 15.6
	14 13.8 13.7	16.7 17.5 16.8	16.7 17.7 16.7	17.3 17.6 16.1
Vertical Electrical Tilt	VARIABLE 0°-10°	VARIABLE 0°-10°	VARIABLE 0°-10°	VARIABLE 0°-10°
Upper Sidelobe Suppression for the 1 st lobe above main beam (dB)	T0 T5 T10	T0 T5 T10	T0 T5 T10	T0 T5 T10
	19 19 19	19 19 17	19 19 17	19 19 17
Front-to-Back Ratio @ 180° ± 20° (dB)	> 28	> 28	> 28	> 28
VSWR	< 1.5 : 1	< 1.5 : 1	< 1.5 : 1	< 1.5 : 1
Cross Polar Ratio @ ± 60° (dB) <i>Typically</i>	> 10	> 10	> 10	> 10
Isolation between Ports (dB)	> 30	> 30	> 30	> 30
Interband Isolation (dB)	> 40 (824-896//1710-2170) > 30 (1710-2170//1710-2170)			
Maximum Power Per Input (W)	500	250		
Intermodulation (dBc)	< - 150			
Impedance (Ω)	50			



MECHANICAL SPECIFICATIONS

Connectors	8 x 7/16 Female
Connector Position	Bottom
Survival Wind Speed km/h (mph)	200 (125)
Front Windload N @ 160 km/h (lbs @ 100 mph)	1410 (317)
Lateral Windload N @ 160 km/h (lbs @ 100 mph)	350 (79)
Radome Color	Grey, paintable
Humidity	100%
Antenna Weight kg (lbs)	40 (88)
Antenna Dimension mm (in) H X W X D	2615 X 345 X 145 (103 X 14 X 6)

H&V Pattern/ Low band

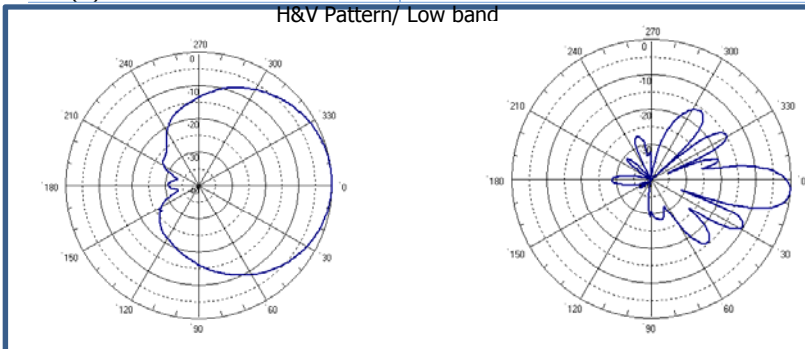

H&V Pattern/ Broadband

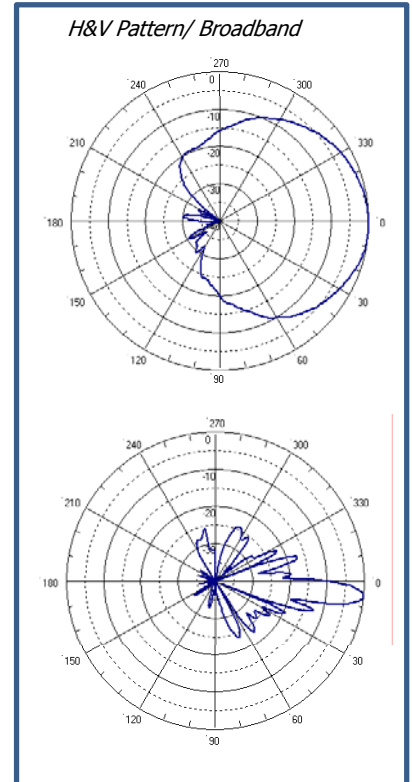

RYMSA Telecom Group (Headquarters)
 Ctra. Campo Real, km. 2,100
 28500 Arganda del Rey (Madrid)-Spain
 Phone : + 34 91 876 06 80
 Fax : + 34 91 875 75 32
 telecom.commercial@rymsa.com



RYMSA México: telecom.commercial@rymsa.com
 Phone: + 52 55 1106 2623
 RYMSA Wireless U.S.A: sales@rymsawireless.com
 Phone: + 1 888 622 6095
 www.rymsawireless.com



MULTI-BAND PANEL ANTENNA

TRIPLE-BAND

MULTI - BAND PANEL ANTENNA								
TRIPLE-BAND PANEL ANTENNA								
BAND 850 + 2 X BROADBAND 1710 - 2170 MHz								
Frequency	HBW	VBW	Gain (dbi)	Polarization	Tilt	Height mm (in)	Model	Page
870 - 960	65°	6°	16	± 45°	Variable 0° - 7°	2615 (103)	TGA3D3-800TV	99
1710 - 1880	65°	6°	17.5		Variable 0° - 10°			
1850 - 1990	65°	6°	17					
1920 - 2170	65°	6°	17					
BAND 900 + 2 X BROADBAND 1710 - 2170 MHz								
Frequency	HBW	VBW	Gain (dbi)	Polarization	Tilt	Height mm (in)	Model	Page
870 - 960	65°	15°	14.5	± 45°	Variable 0° - 10°	1340 (53)	TTD3-400TV	100
1710 - 1880	65°	6°	17		Variable 2° - 10°			
1850 - 1990	65°	6°	17					
1920 - 2170	65°	6°	17					
870 - 960	65°	10°	15.6	± 45°	Variable 0° - 10°	2000 (79)	TTD3-600TV	101
1710 - 1880	65°	6°	17		Variable 2° - 10°			
1850 - 1990	65°	6°	17.1					
1920 - 2170	65°	6°	17.2					
870 - 960	65°	6°	16.6	± 45°	Variable 2° - 10°	2615 (103)	TTD3-800TV	102
1710 - 1880	65°	6°	17.1		Variable 2° - 10°			
1850 - 1990	65°	6°	17					
1920 - 2170	65°	6°	17.1					
3 X BROADBAND 1710 - 2170 MHz								
Frequency	HBW	VBW	Gain (dbi)	Polarization	Tilt	Height mm (in)	Model	Page
1710 - 1880	65°	6°	17	± 45°	Variable 0° - 10°	1340 (53)	MG3D3-800 TV	103
1850 - 1990	65°	6°	17.5		Variable 0° - 10°			
1920 - 2170	65°	6°	17.5		Variable 0° - 10°			

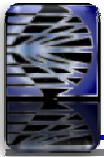

MULTI-BAND PANEL ANTENNA

BAND 850 + 2 X BROADBAND 1710 – 2170 MHZ

TGA3D3-800TV

824 - 896	2 X 1710 - 2170		
824 - 896	1710-1880	1710-1880	1920-2170
H72° V7.3°	H63° V7°	H64° V6.6°	H63° V6.4°
Variable Tilt 0° - 7°	Variable Tilt 0° - 10°	Variable Tilt 0° - 10°	Variable Tilt 0° - 10°

ELECTRICAL SPECIFICATIONS

BAND 850

2 X BROADBAND 1710-2170 MHz

Antenna Model	TGA3D3-800TV			
Polarization	+/- 45°			
	824-896	2 X (1710 – 2170)		
Frequency	824-896	1710-1880	1850-1990	1920-2170
Horizontal Beamwidth	72°	63°	64°	63°
Vertical Beamwidth	7.3°	7°	6.6°	6.4°
Gain (dBi)				
Bottom antenna	16	17.5	17	17
Top Antenna		17	16.5	16.5
Vertical Electrical Tilt	VARIABLE 0°-7°	VARIABLE 0°-10°	VARIABLE 0°-10°	VARIABLE 0°-10°
Upper Sidelobe Suppression for the 1 st lobe above main beam (dB)	T0 T3 T7 18 17 22	T0 T5 T10 19 17 18	T0 T5 T10 20 18 16	T0 T5 T10 18 16 16
Front-to-Back Ratio @ 180° ± 20° (dB)	>26	>23	>25	>25
VSWR	< 1.5 : 1	< 1.5 : 1	< 1.5 : 1	< 1.5 : 1
Cross Polar Ratio @ -3°dB Beamwidth <i>Typically</i>	>15	>15	>15	>15
Isolation between Ports (dB)	>30	>30	>30	>30
Interband Isolation (dB)	> 40 (824-896//1710-2170) > 35 (1710-2170//1710-2170)			
Maximum Power Per Input (W)	500	250		
Intermodulation (dBc)	< - 150			
Impedance (Ω)	50			



MECHANICAL SPECIFICATIONS

Connectors	6 x 7/16 Female
Connector Position	Bottom
Survival Wind Speed km/h (mph)	200 (125)
Front Windload N @ 160 km/h (lbs @ 100 mph)	1380 (310)
Lateral Windload N @ 160 km/h (lbs @ 100 mph)	330 (74)
Radome Color	Grey, paintable
Humidity	100%
Antenna Weight kg (lbs)	35 (77)
Antenna Dimension mm (in) H X W X D	2615 X 345 X 145 (103 X 14 X 6)

H&V Pattern/ Low band

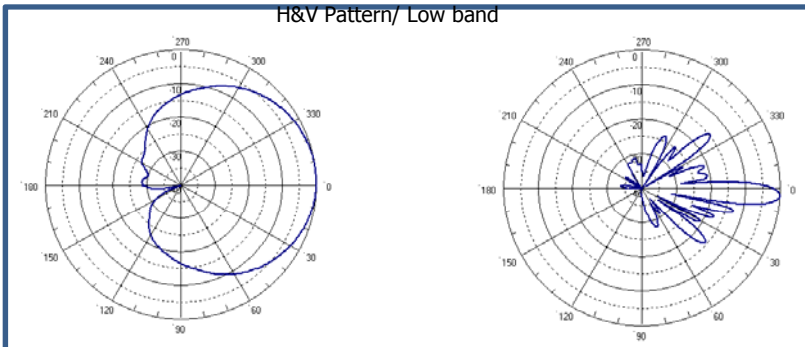

H&V Pattern/ Broadband

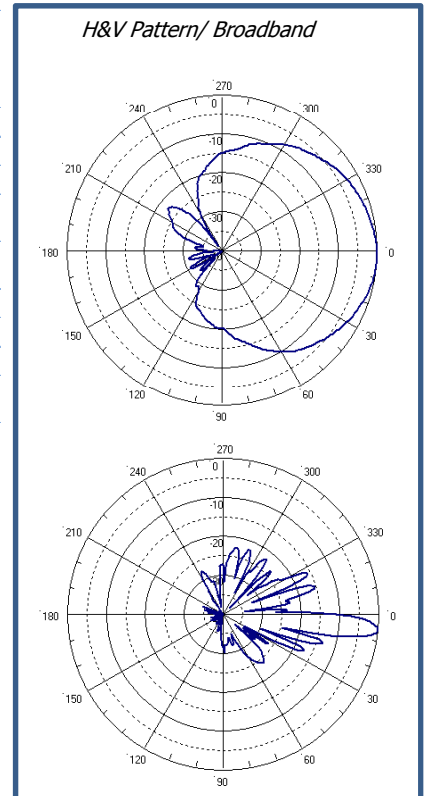

RYMSA Telecom Group (Headquarters)
 Ctra. Campo Real, km. 2,100
 28500 Arganda del Rey (Madrid)-Spain
 Phone : + 34 91 876 06 80
 Fax : + 34 91 875 75 32
 telecom.commercial@rymsa.com



RYMSA México: telecom.commercial@rymsa.com
 Phone: + 52 55 1106 2623
 RYMSA Wireless U.S.A: sales@rymsawireless.com
 Phone: + 1 888 622 6095
 www.rymsawireless.com

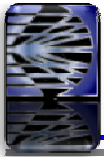

MULTI-BAND PANEL ANTENNA

BAND 900+ 2 X BROADBAND 1710-2170

TTD3-400TV

870 - 960	2 X 1710 - 2170		
870 - 960	1710-1880	1710-1880	1920-2170
H60° V14°	H68° V7°	H65° V6.6°	H61° V6.4°
Variable Tilt 0° - 10°	Variable Tilt 2° - 10°	Variable Tilt 2° - 10°	Variable Tilt 2° - 10°

ELECTRICAL SPECIFICATIONS

BAND 900

2 X BROADBAND 1710-2170 MHz

Antenna Model	TTD3-400TV			
Polarization	± 45°			
Frequency	870-960	2 X (1710 - 2170)		
	870-960	1710-1880	1850-1990	1920-2170
Horizontal Beamwidth	60°	68°	65°	61°
Vertical Beamwidth	14°	7°	6.6°	6.4°
Gain (dBi)	14.5	17	17	17
Vertical Electrical Tilt	VARIABLE 0°-10°	VARIABLE 2°-10°	VARIABLE 2°-10°	VARIABLE 2°-10°
Upper Sidelobe Suppression for the 1 st lobe above main beam (dB)	T0 T5 T10 16 18 18	T2 T6 T10 19 18 16	T2 T6 T10 19 20 17	T2 T6 T10 20 18 18
Front-to-Back Ratio @ 180° ± 20° (dB)	> 25	> 20	> 20	> 20
VSWR	< 1.5 : 1	< 1.5 : 1	< 1.5 : 1	< 1.5 : 1
Cross Polar Ratio @ -3°dB Beamwidth <i>Typically</i>	> 15	> 15	> 15	> 15
Isolation between Ports (dB)	> 30	> 30	> 30	> 30
Interband Isolation (dB)	> 40 (870-960//1710-2170) > 30 (1710-2170//1710-2170)			
Maximum Power Per Input (W)	500	250		
Intermodulation (dBc)	< - 150			
Impedance (Ω)	50			

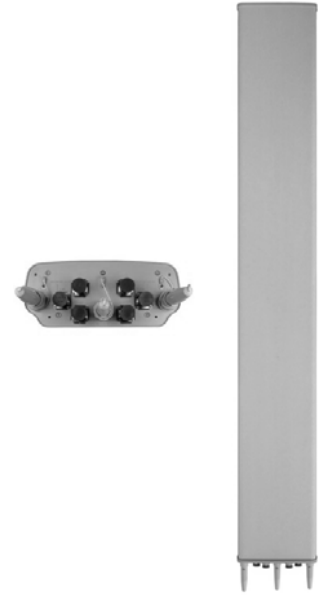

MECHANICAL SPECIFICATIONS

Connectors	6 X 7/16 Female
Connector Position	Bottom
Survival Wind Speed km/h (mph)	200 (125)
Front Windload N @ 160 km/h (lbs @ 100 mph)	680 (153)
Lateral Windload N @ 160 km/h (lbs @ 100 mph)	155 (35)
Radome Color	Grey, paintable
Humidity	100%
Antenna Weight kg (lbs)	22 (48)
Antenna Dimension mm (in) H X W X D	1340 x 345 x 145 (53 X 14 X 6)

H&V Pattern/ Low band

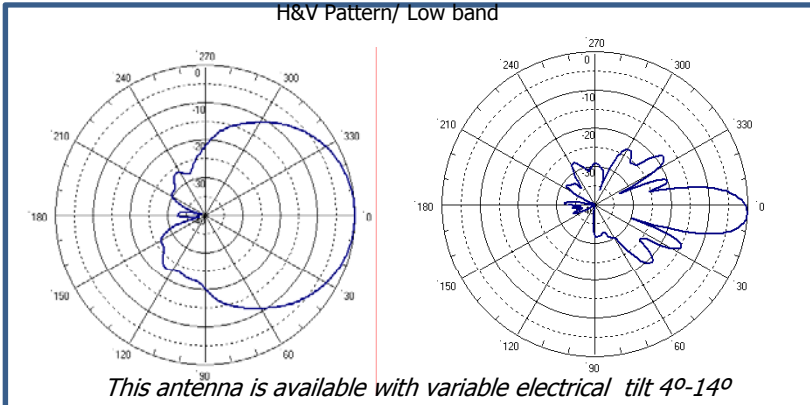

H&V Pattern/ Broadband

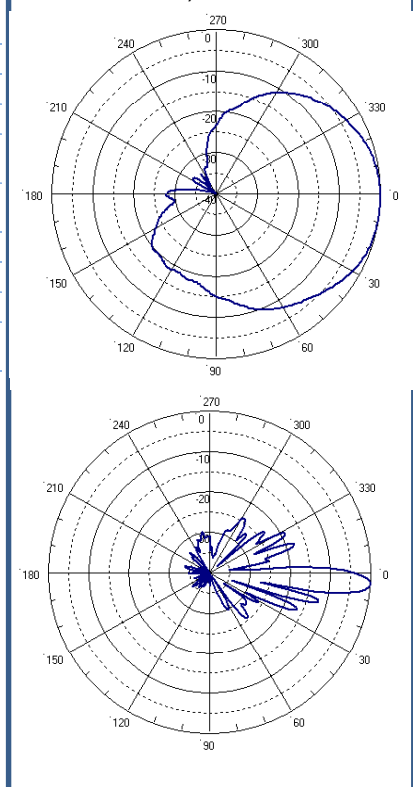

RYMSA Telecom Group (Headquarters)
 Crtra. Campo Real, km. 2,100
 28500 Arganda del Rey (Madrid)-Spain
 Phone : + 34 91 876 06 80
 Fax : + 34 91 875 75 32
 telecom.commercial@rymsa.com



RYMSA México: telecom.commercial@rymsa.com
 Phone: + 52 55 1106 2623
 RYMSA Wireless U.S.A: sales@rymsawireless.com
 Phone: + 1 888 622 6095
 www.rymsawireless.com

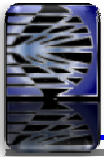

MULTI-BAND PANEL ANTENNA

BAND 900+ 2 X BROADBAND 1710-2170

TTD3-600TV

870 - 960	2 X 1710 - 2170		
870 - 960	1710-1880	1850-1990	1920-2170
H60° V10.7°	H70° V7°	H65° V6.7°	H61° V6.4°
Variable Tilt 2° - 10°	Variable Tilt 2° - 10°	Variable Tilt 2° - 10°	Variable Tilt 2° - 10°

ELECTRICAL SPECIFICATIONS

BAND 900

2 X BROADBAND 1710-2170 MHz

Antenna Model	TTD3-600TV			
Polarization	± 45°			
Frequency	870 - 960		2 X (1710 - 2170)	
	870-960	1710-1880	1850-1990	1920-2170
Horizontal Beamwidth	60°	70°	65°	61°
Vertical Beamwidth	10.7°	7°	6.7°	6.4°
Gain (dBi)	15.6	17	17.1	17.2
Vertical Electrical Tilt	VARIABLE 0°-10°	VARIABLE 2°-10°	VARIABLE 2°-10°	VARIABLE 2°-10°
Upper Sidelobe Suppression for the 1 st lobe above main beam (dB)	T0 T5 T10 16 16 15	T2 T6 T10 17 17 16	T2 T6 T10 20 18 17	T2 T6 T10 20 18 19
Front-to-Back Ratio @180° ± 20° (dB)	> 28	> 22	> 24	> 26
VSWR	< 1.4 : 1	< 1.4 : 1	< 1.4 : 1	< 1.4 : 1
Cross Polar Ratio @ -3°dB Beamwidth Typically	> 15	> 15	> 15	> 15
Isolation between Ports (dB)	> 30	> 30	> 30	> 30
Interband Isolation (dB)	> 40 (870-960//1710-2170) > 30 (1710-2170//1710-2170)			
Maximum Power Per Input (W)	500	250		
Intermodulation (dBc)	< - 150			
Impedance (Ω)	50			



MECHANICAL SPECIFICATIONS

Connectors	6 X 7/16 Female
Connector Position	Bottom
Survival Wind Speed km/h (mph)	200 (125)
Front Windload N @ 160 km/h (lbs @ 100 mph)	1035 (233)
Lateral Windload N @ 160 km/h (lbs @ 100 mph)	240 (54)
Radome Color	Grey, paintable
Humidity	100%
Antenna Weight kg (lbs)	29 (64)
Antenna Dimension mm (in) H X W X D	2000 x 345 x 145 (79 X 14 X 6)

H&V Pattern/ Low band

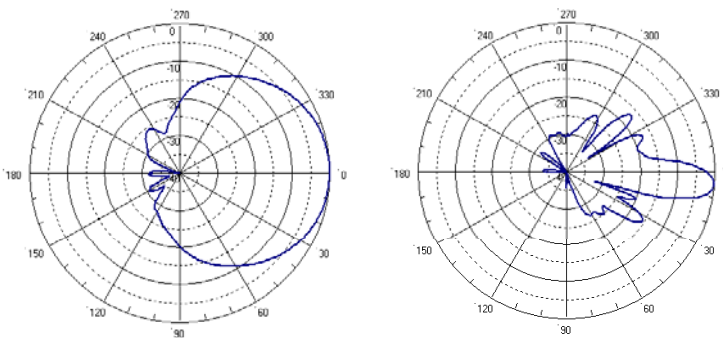

This antenna is available with variable electrical tilt 4°-14°

H&V Pattern/ Broadband

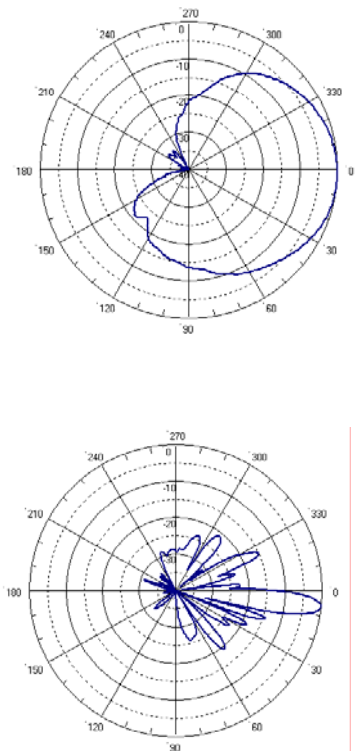

RYMSA Telecom Group (Headquarters)
 Ctra. Campo Real, km. 2,100
 28500 Arganda del Rey (Madrid)-Spain
 Phone : + 34 91 876 06 80
 Fax : + 34 91 875 75 32
 telecom.commercial@rymsa.com



RYMSA México: telecom.commercial@rymsa.com
 Phone: + 52 55 1106 2623
 RYMSA Wireless U.S.A: sales@rymsawireless.com
 Phone: + 1 888 622 6095
 www.rymsawireless.com

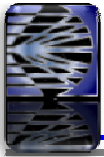

MULTI-BAND PANEL ANTENNA

BAND 900+ 2 X BROADBAND 1710-2170

TTD3-800TV

870 - 960	2 X 1710 - 2170		
870 - 960	1710-1880	1850-1990	1920-2170
H60° V7.5°	H67° V6.8°	H64° V6.6°	H61° V6.3°
Variable Tilt 2° - 10°	Variable Tilt 2° - 10°	Variable Tilt 2° - 10°	Variable Tilt 2° - 10°

ELECTRICAL SPECIFICATIONS

BAND 900

2 X BROADBAND 1710-2170 MHz

Antenna Model	TTD3-800TV			
Polarization	± 45°			
Frequency	870 - 960		2 X (1710 - 2170)	
	870 - 960	1710-1880	1850-1990	1920-2170
Horizontal Beamwidth	60°	67°	64°	61°
Vertical Beamwidth	7.5°	6.8°	6.6°	6.3°
Gain (dBi)	16.6	17.1	17	17.1
Vertical Electrical Tilt	VARIABLE 2°-10°	VARIABLE 2°-10°	VARIABLE 2°-10°	VARIABLE 2°-10°
Upper Sidelobe Suppression for the 1 st lobe above main beam (dB)	T2 T6 T10 20 20 17	T2 T6 T10 19 19 15	T2 T6 T10 20 20 17	T2 T6 T10 20 17 17
Front-to-Back Ratio @ 180° ± 20° (dB)	> 25	> 22	> 22	> 22
VSWR	< 1.5 : 1	< 1.5 : 1	< 1.5 : 1	< 1.5 : 1
Cross Polar Ratio @ -3° (dB) <i>Typically</i>	> 16	> 15	> 15	> 15
Isolation between Ports (dB)	> 30	> 30	> 30	> 30
Interband Isolation (dB)	> 40 (870-960//1710-2170) > 30 (1710-2170//1710-2170)			
Maximum Power Per Input (W)	500	250		
Intermodulation (dBc)	< - 150			
Impedance (Ω)	50			



MECHANICAL SPECIFICATIONS

Connectors	6 X 7/16 Female
Connector Position	Bottom
Survival Wind Speed km/h (mph)	200 (125)
Front Windload N @ 160 km/h (lbs @ 100 mph)	1380 (310)
Lateral Windload N @ 160 km/h (lbs @ 100 mph)	330 (74)
Radome Color	Grey, paintable
Humidity	100%
Antenna Weight kg (lbs)	37 (82)
Antenna Dimension mm (in) H X W X D	2615 x 345 x 145 (103 X 14 X 6)

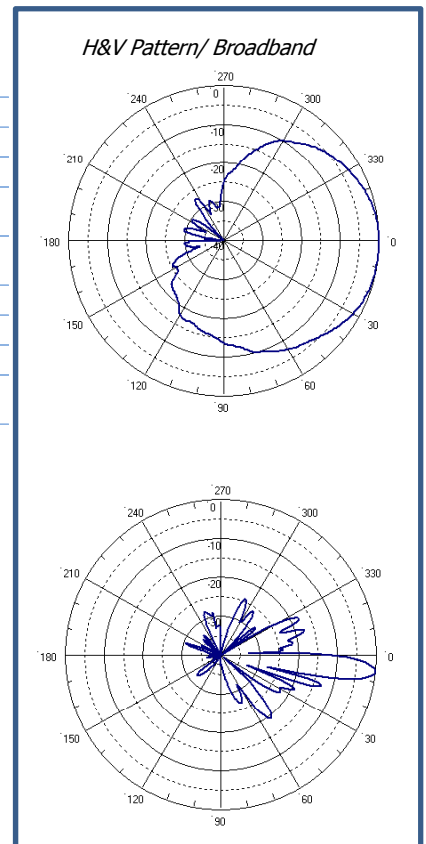
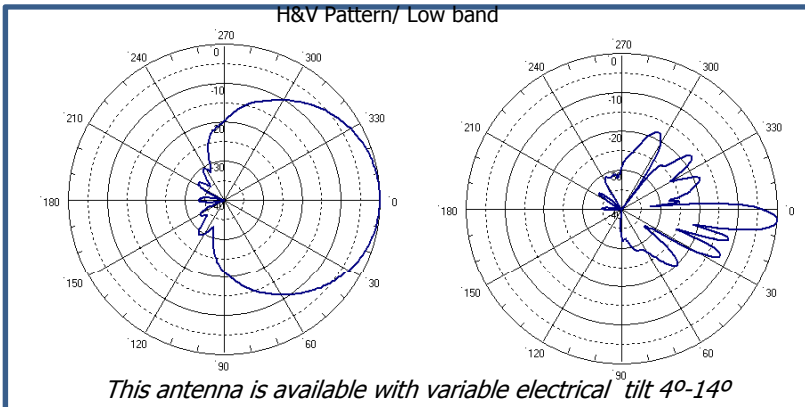

RYMSA Telecom Group (Headquarters)
 Ctra. Campo Real, km. 2.100
 28500 Arganda del Rey (Madrid)-Spain
 Phone : + 34 91 876 06 80
 Fax : + 34 91 875 75 32
 telecom.commercial@rymsa.com



RYMSA México: telecom.commercial@rymsa.com
 Phone: + 52 55 1106 2623
 RYMSA Wireless U.S.A: sales@rymsawireless.com
 Phone: + 1 888 622 6095
 www.rymsawireless.com



MULTI-BAND PANEL ANTENNA

3 X BROADBAND 1710-2170

MG3D3-800TV

3 X 1710 - 2170		
1710-1880	1850-1990	1920-2170
H64° V6.8°	H60° V6.6°	H55° V6.3°
Variable Tilt 0° - 10°	Variable Tilt 0° - 10°	Variable Tilt 0° - 10°

ELECTRICAL SPECIFICATIONS

3 X BROADBAND 1710 – 2170 MHz

Antenna Model	MG3D3-800TV								
Polarization	± 45°								
Frequency	1710 - 1880			1850 - 1990			1920 - 2170		
Horizontal Beamwidth	64°			60°			55°		
Vertical Beamwidth	6.8 °			6.6°			6.3°		
Gain (dBi)	T0 17	T5 17	T10 17.5	T0 17	T5 17.5	T10 17.5	T0 17.5	T5 17.5	T10 18
Vertical Electrical Tilt	VARIABLE 0°-10°			VARIABLE 0°-10°			VARIABLE 0°-10°		
Upper Sidelobe Suppression for the 1 st lobe above main beam (dB)	T0 19	T5 17	T10 17	T0 18	T5 16	T10 16	T0 17	T5 16	T10 16
Front-to-Back Ratio @ 180° ± 20° (dB)	30			30			30		
VSWR	< 1.5 : 1			< 1.5 : 1			< 1.5 : 1		
Cross Polar Ratio @ ± 60° (dB) <i>Typically</i>	> 9			> 9			> 5		
Isolation between Ports (dB)	30			30			30		
Interband Isolation (dB)	> 30 (1710 - 2170//1710 - 2170)								
Maximum Power Per Input (W)	250			250			250		
Intermodulation (dBc)	- 150								
Impedance (Ω)	50								

MECHANICAL SPECIFICATIONS

Connectors	6 X 7/16 Female	
Connector Position	Bottom	
Survival Wind Speed	km/h (mph)	200 (125)
Front Windload	N @ 160 km/h	960 (216)
	(lbs @100 mph)	
Lateral Windload	N @ 160 km/h	130 (29)
	(lbs @100 mph)	
Radome Color	Grey, paintable	
Humidity	100%	
Antenna Weight	kg (lbs)	22 (48)
Antenna Dimension	1340 X 480 X 115 (53 X 108 X 5)	
mm (in) H X W X D		

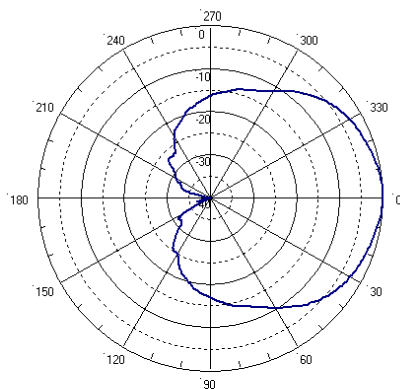

H&V Pattern

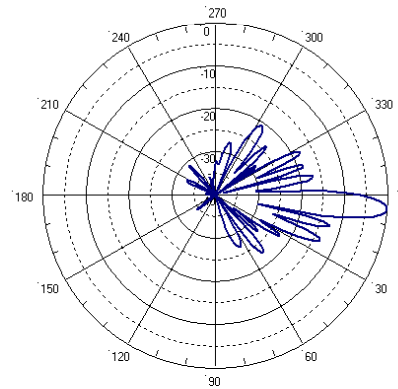

This antenna is available with variable electrical tilt 4°-14°



MULTI-BAND PANEL ANTENNA

TETRA-BAND

MULTI - BAND PANEL ANTENNA								
TETRA-BAND PANEL ANTENNA								
4 X BROADBAND 1710 - 2170 MHz								
Frequency	HBW	VBW	Gain (dbi)	Polarization	Tilt	Height mm (in)	Model	Page
1710 - 1880	65°	6°	17.5	± 45°	Variable 0° - 10°	2660 (105)	BG4D3-800TV	105
1850 - 1990	65°	6°	17.5		Variable 0° - 10°			
1920 - 2170	65°	6°	17.5		Variable 0° - 10°			
BAND 900 + 3 X BROADBAND 1710 - 2170 MHz								
Frequency	HBW	VBW	Gain (dbi)	Polarization	Tilt	Height mm (in)	Model	Page
870 - 960	65°	6°	16.5	± 45°	Variable 3° - 10°	2615 (103)	QB1D3-800TV	106
1710 - 1880	65°	6°	17	± 45°	Variable 2° - 10°			
1850 - 1990	65°	6°	17		Variable 2° - 10°			
1920 - 2170	65°	6°	17		Variable 2° - 10°			
2 X BAND 900 + 2 X BROADBAND 1710 - 2170 MHz								
870 - 960	65°	15°	15	± 45°	Variable 0° - 10°	2615 (103)	QB2D3-800TV	107
1710 - 1880	65°	6°	16.8	± 45°	Variable 2° - 12°			
1850 - 1990	65°	6°	16.8		Variable 2° - 12°			
1920 - 2170	65°	6°	17		Variable 2° - 12°			

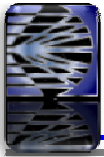

MULTI-BAND PANEL ANTENNA

4 X BROADBAND 1710 – 2170 MHz

BG4D3-800TV

4 X 1710 - 2170		
1710-1880	1850-1990	1920-2170
H65° V6.8°	H63° V6.6°	H61° V6.2°
Variable Tilt 0° - 10°	Variable Tilt 0° - 10°	Variable Tilt 0° - 10°

ELECTRICAL SPECIFICATIONS

4 X BROADBAND 1710 – 2170 MHz

Antenna Model	BG4D3-800TV								
Polarization	± 45°								
Frequency	1710-1880			1850-1990			1920-2170		
Horizontal Beamwidth	65°			63°			61°		
Vertical Beamwidth	6.8°			6.6°			6.2°		
Gain (dBi)	TO	T5	T10	TO	T5	T10	TO	T5	T10
Bottom antennas	17	17.5	17.5	17	17.5	17.5	17	17.5	17
Top Antennas	16.5	17	17	16.5	17	17	17	17	16.5
Vertical Electrical Tilt	VARIABLE 0°-10°			VARIABLE 0°-10°			VARIABLE 0°-10°		
Upper Sidelobe Suppression for the 1 st lobe above main beam (dB)	TO	T5	T10	TO	T5	T10	TO	T5	T10
Front-to-Back Ratio @ 180° ± 20° (dB)	25			25			22		
VSWR	< 1.4 : 1			< 1.4 : 1			< 1.4 : 1		
Cross Polar Ratio @ -3° (dB) <i>Typically</i>	>14			>11			>10		
Isolation between Ports (dB)	>30								
Interband Isolation (dB)	> 31 (1710 – 2170 // 1710 – 2170)								
Maximum Power Per Input (W)	250								
Intermodulation @ 43 dBm (dBc)	- 150								
Impedance (Ω)	50								

MECHANICAL SPECIFICATIONS

Connectors	8 X 7/16 Female
Connector Position	Bottom
Survival Wind Speed km/h (mph)	200 (125)
Front Windload N @ 160 km/h (lbs @100 mph)	1250 (280)
Lateral Windload N @ 160 km/h (lbs @100 mph)	260 (60)
Radome Color	Grey, paintable
Humidity	100%
Antenna Weight kg (lbs)	29 (64)
Antenna Dimension mm (in) H X W X D	2660 X 300 X 90 (105 X 11 X 3)

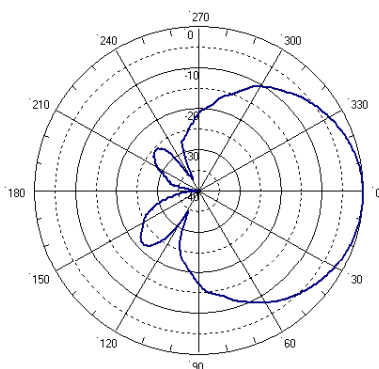

H&V Pattern

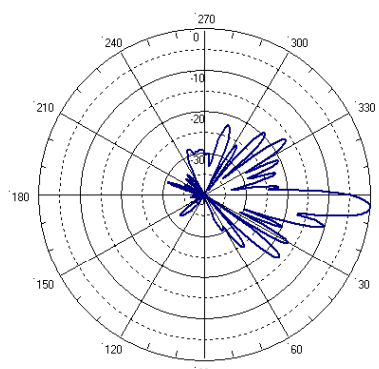



MULTI-BAND PANEL ANTENNA

BAND 900 + 3 X BROADBAND 1710-2170 MHz

QB1D3-800TV

870 - 960	4 X 1710 - 2170		
870 - 960	1710-1880	1850-1990	1920-2170
H60° V7°	H70° V7°	H65° V6.8°	H60° V6.6°
Variable Tilt 3° - 10°	Variable Tilt 2° - 12°	Variable Tilt 2° - 10°	Variable Tilt 2° - 10°

ELECTRICAL SPECIFICATIONS

BAND 900 3 X BROADBAND 1710 - 2170 MHz

Antenna Model	QB1D3-800TV			
Polarization	± 45°			
Frequency	870 - 960	1710-1880	1850-1990	1920-2170
Horizontal Beamwidth	60°	70°	65°	60°
Vertical Beamwidth	7°	7°	6.8°	6.6°
Gain (dBi)				
Top antenna	16.2	16.7	16.6	16.8
Bottom antennas		16.8	16.7	17
Vertical Electrical Tilt	VARIABLE 3°-10°	VARIABLE 2°-12°	VARIABLE 2°-12°	VARIABLE 2°-12°
Upper Sidelobe Suppression for the 1 st lobe above main beam (dB)	T3 T6 T10 19 17 18	T2 T7 T12 17.5 16.5 15	T2 T7 T12 19 17 16	T2 T7 T12 19 17 17
Front-to-Back Ratio @ 180° ± 20° (dB)	20	20	22	23
VSWR	< 1.5 : 1	< 1.5 : 1	< 1.5 : 1	< 1.5 : 1
Cross Polar Ratio @ -3° (dB) Typically	>4	>15		>12
Isolation between Ports (dB)	>30	> 30	> 30	>30
Interband Isolation (dB)	> 40 (870 - 960 // 1710 - 2170) > 31 (1710 - 2170 // 1710 - 2170)			
Maximum Power Per Input (W)	500	250		
Intermodulation @ 43 dBm (dBc)	- 150			
Impedance (Ω)	50			



MECHANICAL SPECIFICATIONS

Connectors	8 X 7/16 Female
Connector Position	Bottom
Survival Wind Speed km/h (mph)	200 (125)
Front Windload N @ 160 km/h (lbs @100 mph)	1380 (310)
Lateral Windload N @ 160 km/h (lbs @100 mph)	330 (74)
Radome Color	Grey, paintable
Temperature Range °C (F)	-55° to +60° (-67° to 140°)
Humidity	100%
Antenna Weight kg (lbs)	40 (88)
Antenna Dimension mm (in) H X W X D	2615 X 345 X 145 (103 X 14 X 6)

H&V Pattern/ Low band

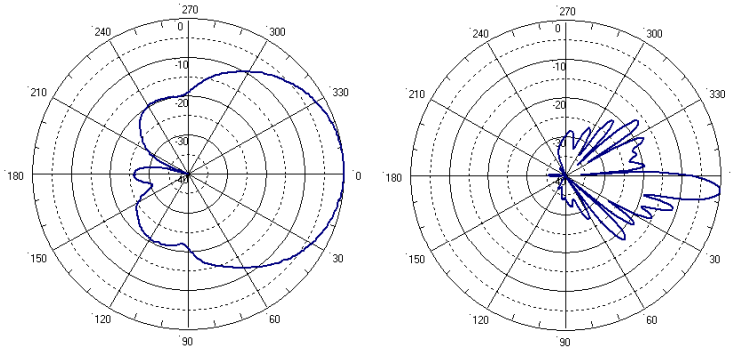

H&V Pattern/ Broadband

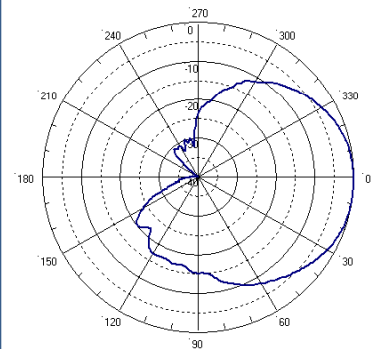

RYMSA Telecom Group (Headquarters)
 Ctra. Campo Real, km. 2.100
 28500 Arganda del Rey (Madrid)-Spain
 Phone : + 34 91 876 06 80
 Fax : + 34 91 875 75 32
 telecom.commercial@rymsa.com



RYMSA México: telecom.commercial@rymsa.com
 Phone: + 52 55 1106 2623
 RYMSA Wireless U.S.A: sales@rymsawireless.com
 Phone: + 1 888 622 6095
 www.rymsawireless.com

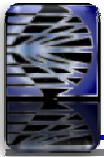

MULTI-BAND PANEL ANTENNA

2 X BAND 900 + 2 X BROADBAND 1710-2170 MHZ

QB2D3-800TV

2 x 870 - 960	2 X 1710 - 2170		
870 - 960	1710-1880	1850-1990	1920-2170
H60° V14°	H68° V7.1°	H64° V6.7°	H61° V6.5°
Variable Tilt 0° - 10°	Variable Tilt 2° - 12°	Variable Tilt 2° - 12°	Variable Tilt 2° - 12°

ELECTRICAL SPECIFICATIONS

Antenna Model	QB2D3-800TV			
	± 45°			
Polarization	± 45°			
Frequency	870-960	1710-1880	1850-1990	1920-2170
Horizontal Beamwidth	60°	68°	64°	61°
Vertical Beamwidth	14°	7.1°	6.7°	6.5°
Gain (dBi)				
Top antenna	15		16.8	
Bottom antenna	14.8	16.8		17
Vertical Electrical Tilt	VARIABLE 0°-10°		VARIABLE 2°-12°	
Upper Sidelobe Suppression for the 1 st lobe above main beam (dB)	T0 T5 T10	T2 T7 T12	T2 T7 T12	T2 T7 T12
Front-to-Back Ratio @ 180° ± 20° (dB)	15 16.5 18	15 20 16	15.5 20 16	14 18.5 15
VSWR	<1.5:1	<1.5:1	<1.5:1	<1.5:1
Cross Polar Ratio @ -3° (dB) Typically	>14	>14	>15	>16
Isolation between Ports (dB)	> 30	> 30	> 30	> 30
Interband Isolation (dB)	> 40 (870 - 960 // 1710 - 2170) > 31 (1710 - 2170 // 1710 - 2170)			
Maximum Power Per Input (W)	500	250		
Intermodulation @ 43 dBm (dBc)	< - 150			
Impedance (Ω)	50			



MECHANICAL SPECIFICATIONS

Connectors	8 X 7/16 Female
Connector Position	Bottom
Survival Wind Speed km/h (mph)	200 (125)
Front Windload N @ 160 km/h (lbs @100 mph)	1380 (310)
Lateral Windload N @ 160 km/h (lbs @100 mph)	330 (74)
Radome Color	Grey, paintable
Humidity	100%
Antenna Weight kg (lbs)	39 (86)
Antenna Dimension mm (in) H X W X D	2615 X 345 X 145 (103 X 14 X 6)

H&V Pattern/ Low band

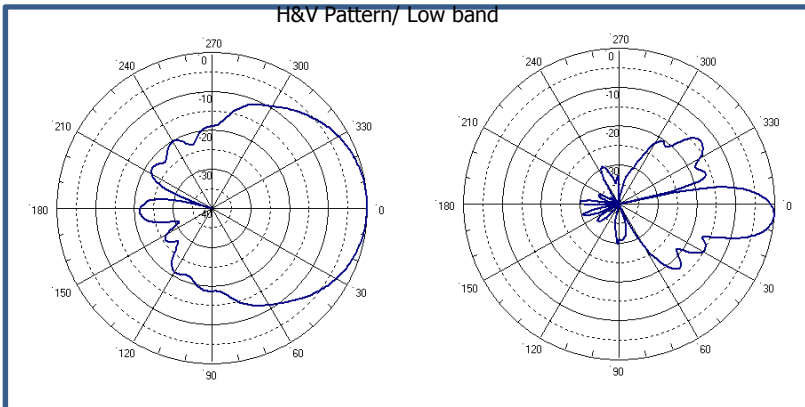

H&V Pattern/ Broadband

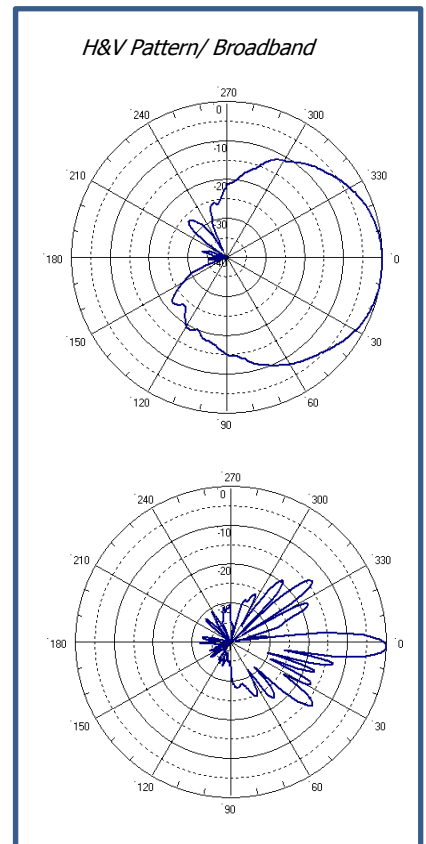

RYMSA Telecom Group (Headquarters)
 Crtra. Campo Real, km. 2.100
 28500 Arganda del Rey (Madrid)-Spain
 Phone : + 34 91 876 06 80
 Fax : + 34 91 875 75 32
 telecom.commercial@rymsa.com



RYMSA México: telecom.commercial@rymsa.com
 Phone: + 52 55 1106 2623
 RYMSA Wireless U.S.A: sales@rymsawireless.com
 Phone: + 1 888 622 6095
 www.rymsawireless.com



MULTIBAND PANEL ANTENNA

PENTABAND

MULTI - BAND PANEL ANTENNA								
PENTABAND								
BAND 900 + 4 X BROADBAND 1710 - 2170 MHz								
Frequency	HBW	VBW	Gain (dbi)	Polarization	Tilt	Height mm (in)	Model	Page
870 - 960	65°	6°	17	± 45°	Variable 3°- 10°	2615 (103)	PT1D3-800TV	109
1710 - 1880	65°	6°	16.5		Variable 2°- 12°			
1850 - 1990	65°	6°	16.5		Variable 2°- 12°			
1920 - 2170	65°	6°	16.5		Variable 2°- 12°			
2 X BAND 900 + 3 X BROADBAND 1710 - 2170 MHz								
870 - 960	65°	15°	14.5	± 45°	Variable 0°- 10°	2615 (103)	PT2D3-800TV	110
1710 - 1880	65°	6°	16.5		Variable 2°- 12°			
1850 - 1990	65°	6°	16.5		Variable 2°- 12°			
1920 - 2170	65°	6°	17		Variable 2°- 12°			

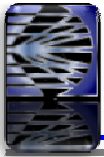

MULTI-BAND PANEL ANTENNA

BAND 900 + 4 X BROADBAND 1710-2170 MHz

PT1D3-800TV

1 X 870 - 960	4 X 1710 - 2170		
870 - 960	1710-1880	1850-1990	1920-2170
H60° V7.2°	H69° V7°	H65° V6.7°	H61° V6.5°
Variable Tilt 3° - 10°	Variable Tilt 2° - 12°	Variable Tilt 2° - 12°	Variable Tilt 2° - 12°

ELECTRICAL SPECIFICATIONS

BAND 900

4 X BROADBAND 1710-2170 MHz

Antenna Model	PT1D3-800TV			
Polarization	± 45°			
Frequency	870 - 960	1710-1880	1850-1990	1920-2170
Horizontal Beamwidth	60°	69	65°	61°
Vertical Beamwidth	7.2°	7°	6.7°	6.5°
Gain (dBi)				
Bottom antennas	17	16.6	16.6	17
Top antennas		16.5	16.5	16.7
Vertical Electrical Tilt	VARIABLE 3°-10°	VARIABLE 2°-12°	VARIABLE 2°-12°	VARIABLE 2°-12°
Upper Sidelobe Suppression for the 1 st lobe above main beam (dB)	T3 T6 T10 19.5 18 20	T2 T7 T12 16 20 18	T2 T7 T12 16 20 17	T2 T7 T12 15 17 16
Front-to-Back Ratio @ 180° ± 20° (dB)	25	20	20	22.5
VSWR	< 1.5 : 1	< 1.5 : 1	< 1.5 : 1	< 1.5 : 1
Cross Polar Ratio @ -3° (dB) <i>Typically</i>	>15	>13	>12	>15
Isolation between Ports (dB)	>30	>30	>30	>30
Interband Isolation (dB)	> 40 (870 - 960 // 1710 - 2170) > 30 (1710 - 2170 // 1710 - 2170)			
Maximum Power Per Input (W)	500	250		
Intermodulation @ 43 dBm (dBc)	- 150			
Impedance (Ω)	50			



MECHANICAL SPECIFICATIONS

Connectors	10 X 7/16 Female
Connector Position	Bottom
Survival Wind Speed km/h (mph)	200 (125)
Front Windload N @ 160 km/h (lbs @100 mph)	1380 (310)
Lateral Windload N @ 160 km/h (lbs @100 mph)	330 (74)
Radome Color	Grey, paintable
Humidity	100%
Antenna Weight kg (lbs)	40 (88)
Antenna Dimension mm (in) H X W X D	2615 X 345 X 145 (103 X 14 X 6)

H&V Pattern/ Low band

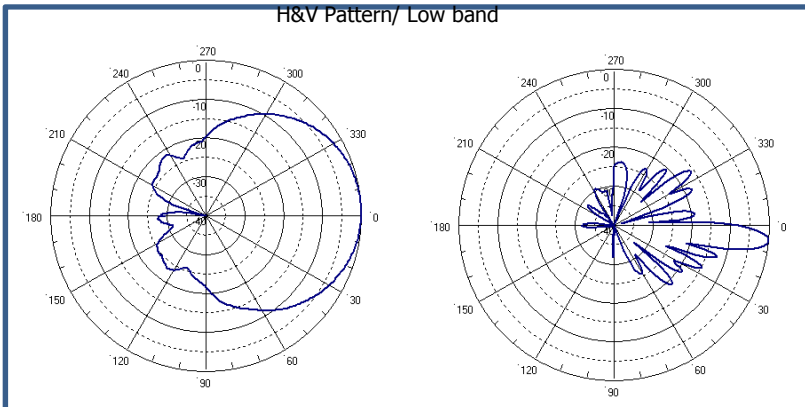

H&V Pattern/ Broadband

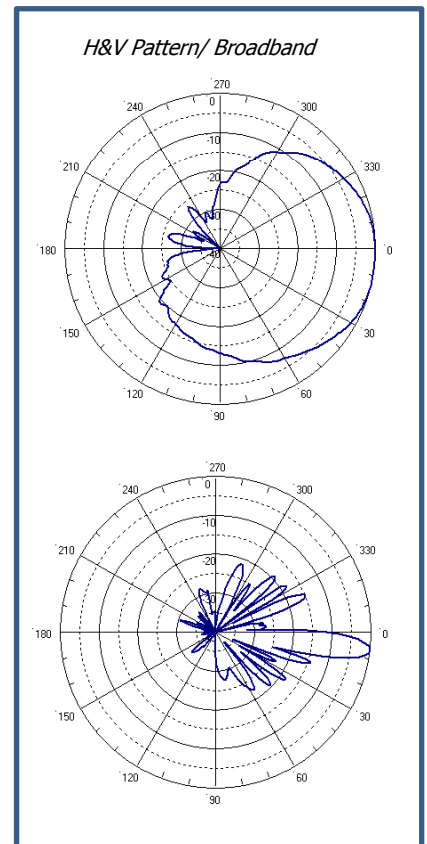

RYMSA Telecom Group (Headquarters)
 Ctra. Campo Real, km. 2.100
 28500 Arganda del Rey (Madrid)-Spain
 Phone : +34 91 876 06 80
 Fax : +34 91 875 75 32
telecom.commercial@rymsa.com

RYMSA
 TELECOM GROUP
www.rymsa.com

RYMSA México: telecom.commercial@rymsa.com
 Phone: +52 55 1106 2623
 RYMSA Wireless U.S.A: sales@rymsawireless.com
 Phone: +1 888 622 6095
www.rymsawireless.com

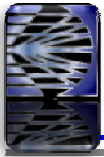

MULTI-BAND PANEL ANTENNA

2 X BAND 900 + 3 X BROADBAND 1710-2170 MHZ

PT2D3-800TV

2 x 870 - 960	3 X 1710 - 2170		
870 - 960	1710-1880	1850-1990	1920-2170
H60° V14°	H69° V7°	H65° V7°	H60° V6.5°
Variable Tilt 0° - 10°	Variable Tilt 2° - 12°	Variable Tilt 2° - 12°	Variable Tilt 2° - 12°

ELECTRICAL SPECIFICATIONS

Antenna Model	PT2D3-800TV			
	± 45°			
Polarization				
Frequency	870-960	1710-1880	1850-1990	1920-2170
Horizontal Beamwidth	60°	69°	65°	60°
Vertical Beamwidth	14°	7°	7°	6.5°
Gain (dBi)				
Bottom antenna	14.5	16.6	16.6	17
Top antenna	14.1	16.5	16.5	16.6
Vertical Electrical Tilt	VARIABLE 0°-10°	VARIABLE 2°-12°	VARIABLE 2°-12°	VARIABLE 2°-12°
Upper Sidelobe Suppression for the 1 st lobe above main beam (dB)	T0 T5 T10 15 16 17	T2 T7 T12 17 16 15	T2 T7 T12 20 18.5 17	T2 T7 T12 18 17 17
Front-to-Back Ratio @ 180° ± 20° (dB)	>22	>20	>22.5	>23.5
VSWR	< 1.5 : 1	< 1.4 : 1	< 1.4 : 1	< 1.4 : 1
Cross Polar Ratio @ -3° (dB) Typically	>13	>15	>15	>15
Isolation between Ports (dB)	> 30	> 30	>30	>30
Interband Isolation (dB)	> 40 (870 - 960 // 1710 - 2170) > 30 (1710 - 2170 // 1710 - 2170)			
Maximum Power Per Input (W)	500	250		
Intermodulation @ 43 dBm (dBc)	- 150			
Impedance (Ω)	50			



MECHANICAL SPECIFICATIONS

Connectors	10 X 7/16 Female
Connector Position	Bottom
Survival Wind Speed km/h (mph)	200 (125)
Front Windload N @ 160 km/h (lbs @100 mph)	1380 (310)
Lateral Windload N @ 160 km/h (lbs @100 mph)	330 (74)
Radome Color	Grey, paintable
Humidity	100%
Antenna Weight kg (lbs)	41 (90)
Antenna Dimension (mm) H X D	2615 X 345 X 145 (103 X 14 X 6)

H&V Pattern/ Broadband

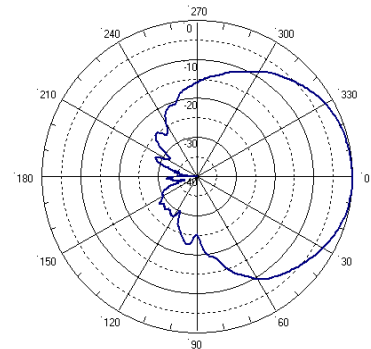

H&V Pattern/ Low band

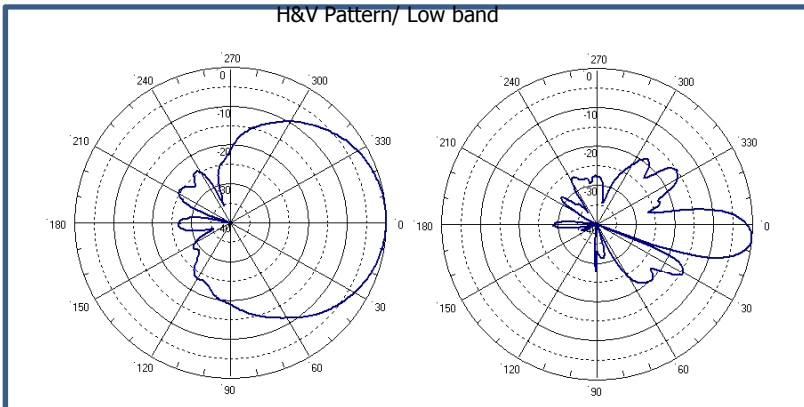

RYMSA Telecom Group (Headquarters)
 Crtra. Campo Real, km. 2.100
 28500 Arganda del Rey (Madrid)-Spain
 Phone : + 34 91 876 06 80
 Fax : + 34 91 875 75 32
 telecom.commercial@rymsa.com



RYMSA México: telecom.commercial@rymsa.com
 Phone: + 52 55 1106 2623
 RYMSA Wireless U.S.A: sales@rymsawireless.com
 Phone: + 1 888 622 6095
 www.rymsawireless.com



TRI-SECTOR ANTENNA

3 X BROADBAND 1710-2170 MHZ

TRI-SECTOR ANTENNA												
3 X BROADBAND 1710 - 2170 MHz												
	Frequency	HBW	VBW	Gain (dbi)	Polarization	Tilt	Radome	Azimuth	Height	mm (in)	Model	Page
3 X 1710 - 2170	1710 - 1880	65°	15°	14.7	± 45°	Variable 0°- 16°	Multi-Radome	Variable	Antenna Size: 840 X 360 (33 X 14) Service Module: 310 X 390 (12 X 15)	TSD3-400TV Multi-Radome	112	
	1850 - 1990	65°	15°	15	± 45°	Variable 0°- 16°						
	1920 - 2170	65°	10°	15.2	± 45°	Variable 0°- 16°						
3 X 1710 - 2170	1710 - 1880	65°	6°	17.6	± 45°	Variable 0°- 10°	Multi-Radome	Variable	Antenna Size: 1380 X 360 (54 X 14) Service Module: 310 X 390 (12 X 15)	TSD3-800TV Multi-Radome	113	
	1850 - 1990	65°	6°	18	± 45°	Variable 0°- 10°						
	1920 - 2170	65°	6°	18.2	± 45°	Variable 0°- 10°						
3 X 1710 - 2170	1710 - 1880	65°	15°	14.5	± 45°	Fixed 0°, 2°, 4°, 6°	Mono-Radome	Fixed	Antenna Size: 610 X 250 (24 X 10)	SBD3-400TX Mono-Radome	114	
	1850 - 1990	65°	15°	14.6	± 45°	Fixed 0°, 2°, 4°, 6°						
	1920 - 2170	65°	15°	15	± 45°	Fixed 0°, 2°, 4°, 6°						
3 X 1710 - 2170	1710 - 1880	65°	6°	17	± 45°	Variable 0°- 10°	Mono-Radome	Fixed	Antenna Size: 1680 X 205 (66 X 8) Service Module: 365 X 230 (14 X 9)	SBD3-800TV Mono-Radome	115	
	1850 - 1990	65°	6°	17.5	± 45°	Variable 0°- 10°						
	1920 - 2170	65°	6°	17.5	± 45°	Variable 0°- 10°						
3 X 1710 - 2170	1710 - 1880	65°	6°	18	± 45°	Variable 0°- 8°	Mono-Radome	Variable	Antenna Size: 1850 X 250 (73 X 10) Service Module: 295 X 250 (11 X 10)	SBD3-900TV Mono-Radome	116	
	1850 - 1990	65°	6°	18	± 45°	Variable 0°- 8°						
	1920 - 2170	65°	4°	18.5	± 45°	Variable 0°- 8°						

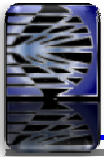

MULTI-RADOME TRI-SECTOR ANTENNA

3 X BROADBAND 1710-2170 MHz

TSD3-400TV

WITH 3 STANDARDS ANTENNAS
sector = BROADBAND

ELECTRICAL SPECIFICATIONS

3 X BROADBAND 1710 – 2170 MHz

3 X 1710 - 2170		
1710-1880	1850-1990	1920-2170
H68° V14°	H66° V13°	H62° V12.5°
Variable Tilt 0° - 10°	Variable Tilt 0° - 10°	Variable Tilt 0° - 10°

Antenna Model	TSD3-400TV		
Polarization	± 45°		
Frequency	3 X (1710 – 2170)		
	1710 - 1880	1850 - 1990	1920 - 2170
Horizontal Beamwidth	68°	66°	62°
Vertical Beamwidth	14°	13°	12.5°
Gain (dBi)	14.7	15	15.2
Vertical Electrical Tilt	VARIABLE 0°-16°	VARIABLE 0°-16°	VARIABLE 0°-16°
Variable Azimuth	-20° to +20°		
Upper Sidelobe Suppression for the 1 st lobe above main beam (dB)	17	17	17
Front-to-Back Ratio @ 180° ± 20° (dB)	> 30	> 30	> 30
VSWR	< 1.4 : 1	< 1.4 : 1	< 1.4 : 1
Cross Polar Ratio @ ± 60° (dB) Typically	> 10	> 10	> 10
Isolation between Ports (dB)	> 30	> 30	> 30
Interband Isolation (dB)	> 30 (1710-2170//1710-2170)		
Maximum Power Per Input (W)	250		
Intermodulation (dBc)	< - 150		
Impedance (Ω)	50		



MECHANICAL SPECIFICATIONS

Connectors	6 X 7/16 Female
Connector Position	Bottom
Survival Wind Speed km/h (mph)	200 (125)
Windload N @ 160 km/h (lbs @100 mph)	275 (61)
Radome Color	Grey, paintable
Humidity	100%
Antenna Weight kg (lbs)	55 (121)
Antenna Dimension mm (in) H X Diam	Antenna Size: 840 X 360 (33 X 14) Service Module: 310 X 390 (12 X 15)

Tri-Sector configuration

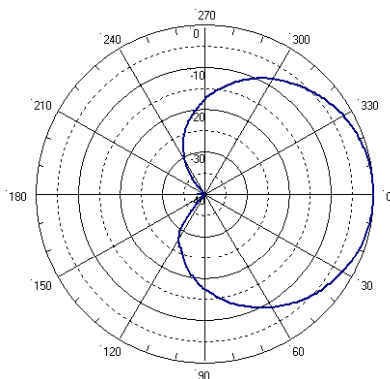
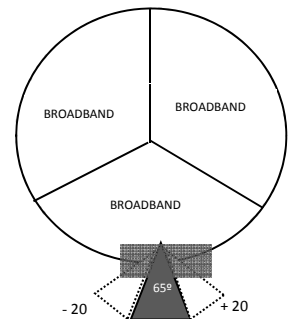

H&V Pattern

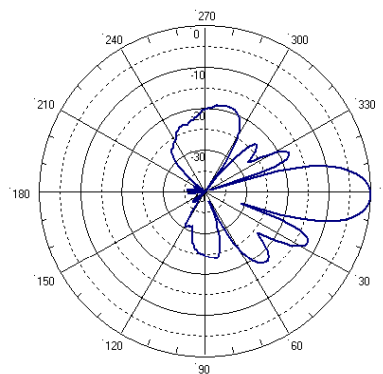

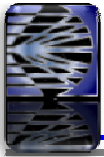

MULTI-RADOME TRI-SECTOR ANTENNA

3 X BROADBAND 1710-2170 MHZ

TSD3-800TV

WITH 3 STANDARDS ANTENNAS
sector = BROADBAND

3 X BROADBAND 1710 - 2170 MHZ

ELECTRICAL SPECIFICATIONS

3 X 1710 - 2170		
1710-1880	1850-1990	1920-2170
H67° V6.8°	H65° V6.6°	H63° V6.3°
Variable Tilt 0° - 10°	Variable Tilt 0° - 10°	Variable Tilt 0° - 10°

Antenna Model	TSD3-800TV		
Polarization	± 45°		
Frequency	3 X (1710 - 2170)		
	1710 - 1880	1850 - 1990	1920 - 2170
Horizontal Beamwidth	67°	65°	63°
Vertical Beamwidth	6.8°	6.6°	6.3°
Gain (dBi)	17.6	18	18.2
Vertical Electrical Tilt	VARIABLE 0°-10°	VARIABLE 0°-10°	VARIABLE 0°-10°
Variable Azimuth	-20° to +20°		
Upper Sidelobe Suppression for the 1 st lobe above main beam (dB)	18	18	18
Front-to-Back Ratio @ 180° ± 20° (dB)	> 30	> 30	> 30
VSWR	< 1.4 : 1	< 1.4 : 1	< 1.4 : 1
Cross Polar Ratio @ ± 60° (dB) <i>Typically</i>	> 10	> 10	> 10
Isolation between Ports (dB)	> 30	> 30	> 30
Interband Isolation (dB)	> 30 (1710-2170//1710-2170)		
Maximum Power Per Input (W)	250		
Intermodulation (dBc)	< - 150		
Impedance (Ω)	50		



Tri-Sector configuration

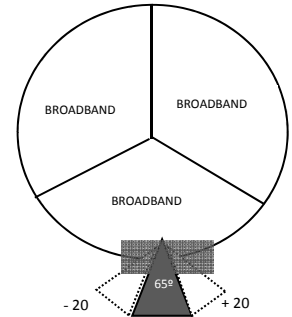

MECHANICAL SPECIFICATIONS

Connectors	6 X 7/16 Female	
Connector Position	Bottom	
Survival Wind Speed km/h (mph)	200 (125)	
Windload N @ 160 km/h (lbs @100 mph)	410 (92)	
Radome Color	Grey, paintable	
Humidity	100%	
Antenna Weight kg (lbs)	70 (154)	
Antenna Dimension mm (in) H X Diam	Antenna Size: 1380 x 360 (54 X 14) Service Module: 310 X 390 (12 X 15)	

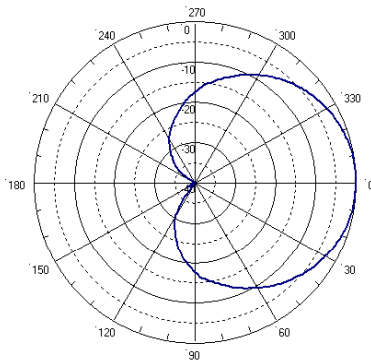

H&V Pattern

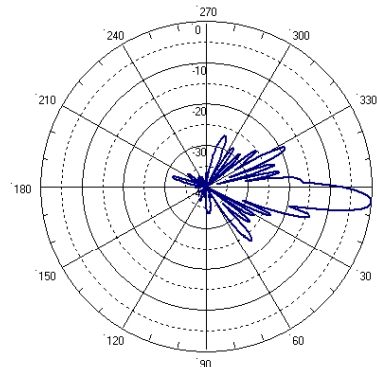



MONO-RADOME TRI-SECTOR ANTENNA

3 X BROADBAND 1710-2170 MHz

SBD3-400TX

3 X 1710 - 2170		
1710-1880	1850-1990	1920-2170
H69° V16.6°	H66° V15.8°	H63° V14.1°
Fixed Tilt 0°,2°,4°,6°	Fixed Tilt 0°,2°,4°,6°	Fixed Tilt 0°,2°,4°,6°

ELECTRICAL SPECIFICATIONS

3 X BROADBAND 1710 – 2170 MHz

Antenna Model	SBD3-400TX		
Polarization	+/- 45°		
Frequency	3 X (1710 – 2170)		
	1710 - 1880	1850 - 1990	1920 - 2170
Horizontal Beamwidth	69°	66°	63°
Vertical Beamwidth	16.6°	15.8°	14.1°
Gain (dBi)	14.5	14.6	15
Vertical Electrical Tilt	FIXED 0°,2°,4°,6°	FIXED 0°,2°,4°,6°	FIXED 0°,2°,4°,6°
Upper Sidelobe Suppression for the 1 st lobe above main beam (dB)	13	13	13
Front-to-Back Ratio @ 180° ± 20° (dB)	> 30	> 30	> 30
VSWR	< 1.5 : 1	< 1.5 : 1	< 1.5 : 1
Cross Polar Ratio @ ± 60° (dB) <i>Typically</i>	> 12	> 10	> 8
Isolation between Ports (dB)	> 30	> 30	> 30
Maximum Power Per Input (W)	250		
Intermodulation (dBc)	< - 150		
Impedance (Ω)	50		



MECHANICAL SPECIFICATIONS

Connectors	6 X 7/16 Female
Connector Position	Bottom
Survival Wind Speed km/h (mph)	200 (125)
Windload N @ 160 km/h (lbs @100 mph)	100 (22)
Radome Color	Grey, paintable
Humidity	100%
Antenna Weight kg (lbs)	10 (22)
Antenna Dimension mm (in) H X Diam	Antenna Size: 610 X 250 (24 X 10)

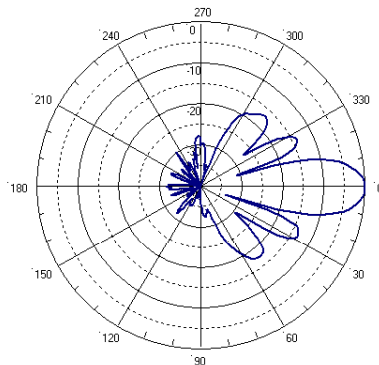
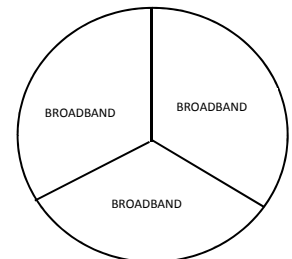

H&V Pattern

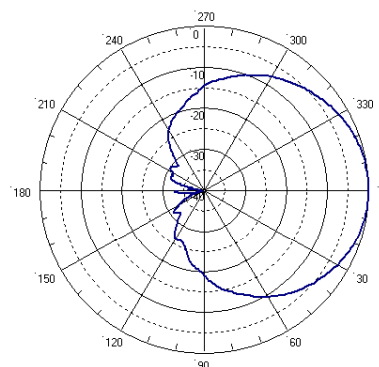

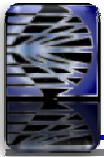

MONO-RADOME TRI-SECTOR ANTENNA

3 X BROADBAND 1710-2170 MHZ

SBD3-800TV

3 X 1710 - 2170		
1710-1880	1850-1990	1920-2170
H67° V6.9°	H64° V6.6°	H62° V6.4°
Variable Tilt 0° - 10°	Variable Tilt 0° - 10°	Variable Tilt 0° - 10°

ELECTRICAL SPECIFICATIONS

3 X BROADBAND 1710 - 2170 MHz

Antenna Model	SBD3-800TV								
Polarization	+/- 45°								
Frequency	3 X (1710 - 2170)								
	1710 - 1880			1850 - 1990			1920 - 2170		
Horizontal Beamwidth	67°			64°			62°		
Vertical Beamwidth	6.9°			6.6°			6.4°		
Gain (dBi)	T0	T5	T10	T0	T5	T10	T0	T5	T10
	17	17	17	17.5	17.5	17	18	17.5	17
Vertical Electrical Tilt	VARIABLE 0°-10°			VARIABLE 0°-10°			VARIABLE 0°-10°		
Upper Sidelobe Suppression for the 1 st lobe above main beam (dB)	T0	T4	T8	T0	T4	T8	T0	T4	T8
	17	15	15	17	16	15	18	17	15
Front-to-Back Ratio @ 180° ± 20° (dB)	> 30			> 30			> 30		
VSWR	< 1.5 : 1			< 1.5 : 1			< 1.5 : 1		
Cross Polar Ratio @ ± 60° (dB)	> 12			> 10			> 8		
Isolation between Ports (dB)	> 30			> 30			> 30		
Interband Isolation (dB)	> 30 (1710-2170//1710-2170)								
Maximum Power Per Input (W)	250								
Intermodulation (dBc)	< - 150								
Impedance (Ω)	50								

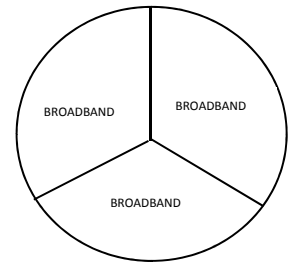

MECHANICAL SPECIFICATIONS

Connectors	6 X 7/16 Female	
Connector Position	Bottom	
Survival Wind Speed km/h (mph)	200 (125)	
Windload N @ 160 km/h (lbs @100 mph)	300 (67)	
Radome Color	Grey, paintable	
Humidity	100%	
Antenna Weight kg (lbs)	45 (99)	
Antenna Dimension mm (in) H X Diam	Antenna Size: 1680 X 205 (66 X 8) Service Module: 365 X 230 (14 X 9)	

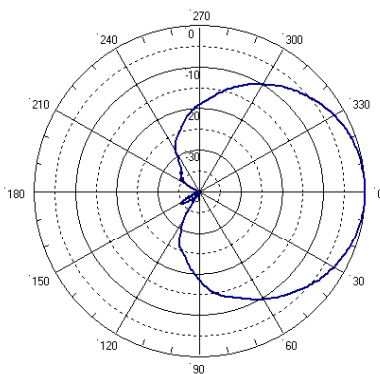

H&V Pattern

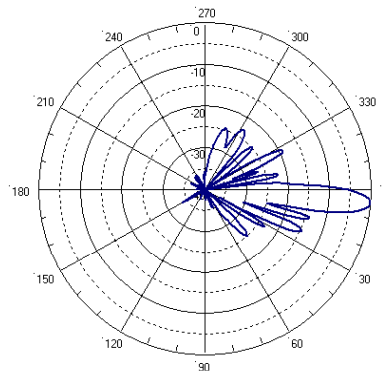

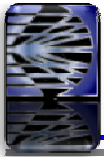

MONO-RADOME TRI-SECTOR ANTENNA

3 X BROADBAND 1710-2170 MHZ

SBD3-900TV-AV

* Tentative specs.

3 X 1710 - 2170		
1710-1880	1850-1990	1920-2170
H69° V5.1°	H67° V5°	H65° V4.8°
Variable Tilt 0° - 8°	Variable Tilt 0° - 8°	Variable Tilt 0° - 8°

ELECTRICAL SPECIFICATIONS

3 X BROADBAND 1710 - 2170 MHZ

Antenna Model	SBD3-900TV								
Polarization	+/- 45°								
Frequency	3 X (1710 - 2170)								
	1710 - 1880			1850 - 1990			1920 - 2170		
Horizontal Beamwidth	69°			67°			65°		
Vertical Beamwidth	5.1°			5°			4.8°		
Gain (dBi)	T0	T4	T8	T0	T4	T8	T0	T4	T8
	17.5	18	18	17.5	18	18	18	18.5	18
Vertical Electrical Tilt	VARIABLE 0°-8°			VARIABLE 0°-8°			VARIABLE 0°-8°		
Azimuth Variable	-10° to +10°								
Upper Sidelobe Suppression for the 1 st lobe above main beam (dB)	T0	T4	T8	T0	T4	T8	T0	T4	T8
	19	19	16	19	19	16	19	18	16
Front-to-Back Ratio @ 180° ± 20° (dB)	> 30			> 30			> 30		
VSWR	< 1.5 : 1			< 1.5 : 1			< 1.5 : 1		
Cross Polar Ratio @ ± 60° (dB)	> 10			> 10			> 8		
Isolation between Ports (dB)	> 30			> 30			> 30		
Interband Isolation (dB)	> 30 (1710-2170//1710-2170)								
Maximum Power Per Input (W)	250								
Intermodulation (dBc)	< - 150								
Impedance (Ω)	50								

MECHANICAL SPECIFICATIONS

Connectors	6 X 7/16 Female	
Connector Position	Bottom	
Survival Wind Speed	km/h (mph)	200 (125)
Windload	460 (104)	
N @ 160 km/h	(lbs @100 mph)	
Radome Color	Grey, paintable	
Humidity	100%	
Antenna Weight	kg (lbs)	45 (100)
Antenna Dimension	Antenna Size: 1850 X 250 (73 X 10)	
mm (in) H X Diam	Service Module: 295 x 250 (11 X 10)	

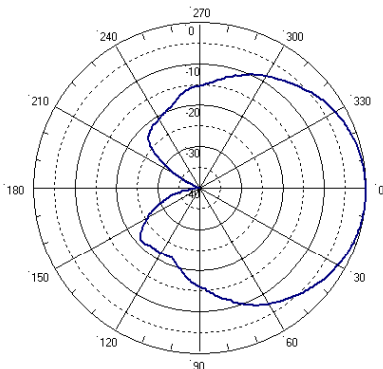
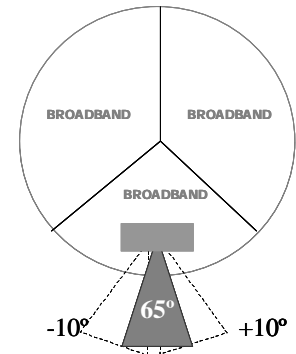

H&V Pattern

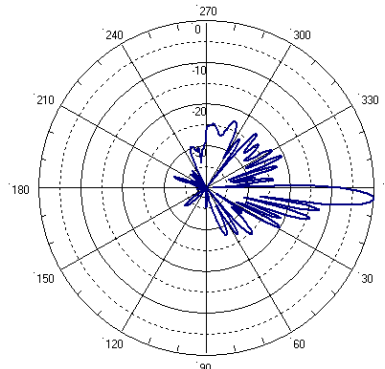

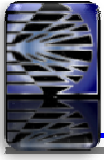

MONO RADOME TRI-SECTOR ANTENNA

HIGH BAND SIDE BY SIDE

MONO-RADOME TRI SECTOR ANTENNA												
HIGH BAND SIDE BY SIDE												
3 X (2 X 1710 - 2170)												
	Frequency	HBW	VBW	Gain (dbi)	Polarization	Tilt	Radome	Azimuth	Height	mm (in)	Model	Page
3 X (2 X 1710 - 2170)	1710 - 1880	65°	6°	17.5	± 45°	Variable 0°- 10°	Mono-Radome	Variable	Antenna Size: 1850 X 350 (73 X 14) Service Module: 400 X 360 (16 X 14)		SBBG-800TV-AV	118
	1850 - 1990	65°	6°	17.5		Variable 0°- 10°						
	1920 - 2170	65°	6°	18		Variable 0°- 10°						

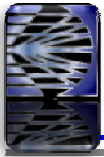

MONO RADOME TRI-SECTOR ANTENNA

HIGH BAND SIDE BY SIDE

SBBG-800TV-AV

3 X (2 X 1710 - 2170)		
1710-1880	1850-1990	1920-2170
H70° V6.3°	H69° V6.2°	H69° V6°
Variable Tilt 0° - 10°	Variable Tilt 0° - 10°	Variable Tilt 0° - 10°

ELECTRICAL SPECIFICATIONS

3 X (2 X BROADBAND 1710 – 2170 MHz)

Antenna Model	SBBG-800TV-AV								
Polarization	± 45°								
Frequency	3 X (2 X 1710 – 2170)								
	1710 - 1880			1850 - 1990			1920 - 2170		
Horizontal Beamwidth	70°			69°			69°		
Vertical Beamwidth	6.3°			6.2°			6°		
Gain (dBi)	T0	T5	T10	T0	T5	T10	T0	T5	T10
	17	17.5	17	17	17.5	17	17.5	18	17
Vertical Electrical Tilt	VARIABLE 0°-10°			VARIABLE 0°-10°			VARIABLE 0°-10°		
Azimuth variable	-10° to +10°								
Upper Sidelobe Suppression for the 1 st lobe above main beam (dB)	T0	T5	T10	T0	T5	T10	T0	T5	T10
	20	17	16	20	19	17	20	19	17
Front-to-Back Ratio @ 180° ± 20° (dB)	> 30			> 30			> 30		
VSWR	< 1.4 : 1			< 1.4 : 1			< 1.4 : 1		
Cross Polar Ratio @ ± 60° (dB)	> 10			> 10			> 10		
Isolation between Ports (dB)	> 30			> 30			> 30		
Interband Isolation (dB)	> 33 (1710-2170//1710-2170)								
Maximum Power Per Input (W)	250								
Intermodulation (dBc)	< - 150								
Impedance (Ω)	50								



MECHANICAL SPECIFICATIONS

Connectors	12 X 7/16 Female	
Connector Position	Bottom	
Survival Wind Speed	km/h (mph)	200 (125)
Windload		490 (110)
N @ 160 km/h	(lbs @100 mph)	
Radome Color	Grey, paintable	
Humidity	100%	
Antenna Weight	kg (lbs)	65 (143)
Antenna Dimension	Antenna Size: 1850 X 350 (73 X 14)	
mm (in) H X W X D	Service Module: 400 X 360 (16 X 14)	

Tri-Sector configuration

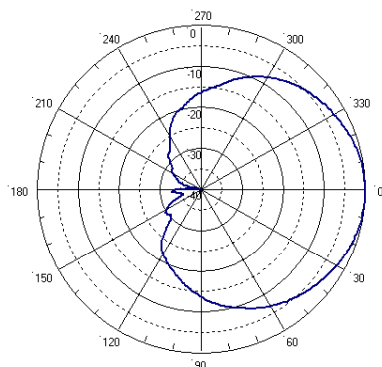
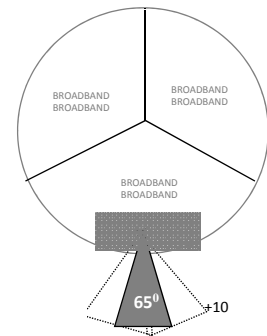

H&V Pattern

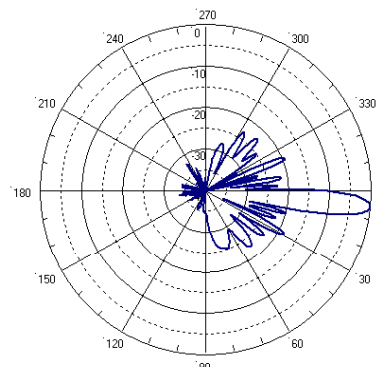



MONO RADOME TRI-SECTOR ANTENNA

DUAL BAND

MONO RADOME TRI-SECTOR ANTENNA												
DUAL BAND												
3 X (BAND 850 + 1850 - 2170 MHz)												
	Frequency	HBW	VBW	Gain (dbi)	Polarization	Tilt	Radome	Azimuth	Height	mm (in)	Model	Page
3 X 824 - 896	824 - 960	65°	15°	13.5	± 45°	Variable 0°- 10°	Mono-Radome	Variable	Antenna Size: 1420 X 505 (56 X 20) Service Module: 295 X 510 (12 X 20)	SBTGA-400TV-AV	120	
3 X 1850 - 2170	1850 - 1990	65°	6°	17.5	± 45°	Variable 0°- 10°						
	1920 - 2170	65°	6°	17.5		Variable 0°- 10°						
3 X 824 - 896	824 - 960	65°	6°	16.5	± 45°	Variable 0°- 8°	Mono-Radome	Variable	Antenna Size: 2700 X 505 (106 X 20) Service Module: 295 X 510 (12 X 20)	SBTGA-800TV-AV	121	
3 X 1850 - 2170	1850 - 1990	65°	6°	17.5	± 45°	Variable 0°- 10°						
	1920 - 2170	65°	6°	17.5		Variable 0°- 10°						
3 X (BAND 850 + BROADBAND 1710 - 2170 MHz)												
3 X 824 - 896	870 - 960	65°	15°	13.5	± 45°	Variable 0°- 10°	Mono-Radome	Variable	Antenna Size: 1420 X 505 (56 X 20) Service Module: 295 X 510 (12 X 20)	SBTGA-400TV-AV-EX	122	
3 X 1710 - 2170	1710 - 1880	65°	6°	17.5	± 45°	Variable 0°- 10°						
	1850 - 1990	65°	6°	17.5		Variable 0°- 10°						
	1920 - 2170	65°	6°	17.5	Variable 0°- 10°							
3 X 824 - 896	824 - 960	65°	6°	16.5	± 45°	Variable 0°- 8°	Mono-Radome	Variable	Antenna Size: 2700 X 505 (106 X 20) Service Module: 295 X 510 (12 X 20)	SBTGA-800TV-AV-EX	123	
3 X 1710 - 2170	1710 - 1880	65°	6°	17.5	± 45°	Variable 0°- 10°						
	1850 - 1990	65°	6°	17.5		Variable 0°- 10°						
	1920 - 2170	65°	6°	17.5		Variable 0°- 10°						
3 X (BAND 900 + BROADBAND 1710 - 2170 MHz)												
3 X 870 - 960	870 - 960	65°	15°	14.5	± 45°	Variable 0°- 10°	Mono-Radome	Variable	Antenna Size: 1420 X 505 (56 X 20) Service Module: 295 X 510 (12 X 20)	SBTG-400TV-AV	124	
3 X 1710 - 2170	1710 - 1880	65°	6°	17.5	± 45°	Variable 2°- 10°						
	1850 - 1990	65°	6°	17.5		Variable 2°- 10°						
	1920 - 2170	65°	6°	18		Variable 2°- 10°						
3 X 870 - 960	870 - 960	65°	10°	15.5	± 45°	Variable 0°- 10°	Mono-Radome	Variable	Antenna Size: 2045 X 507 (81 X 20) Service Module: 390 X 510 (15 X 20)	SBTG-600TV-AV	125	
3 X 1710 - 2170	1710 - 1880	65°	6°	17	± 45°	Variable 2°- 10°						
	1850 - 1990	65°	6°	18		Variable 2°- 10°						
	1920 - 2170	65°	6°	18		Variable 2°- 10°						
3 X 870 - 960	870 - 960	65°	6°	16	± 45°	Variable 2°- 10°	Mono-Radome	Variable	Antenna Size: 2700 X 505 (106 X 20) Service Module: 295 X 510 (12 X 20)	SBTG-800TV-AV	126	
3 X 1710 - 2170	1710 - 1880	65°	6°	17.5	± 45°	Variable 2°- 10°						
	1850 - 1990	65°	6°	17.5		Variable 2°- 10°						
	1920 - 2170	65°	6°	18		Variable 2°- 10°						

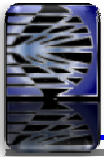

MONO RADOME TRI-SECTOR ANTENNA

3 X (BAND 850 + BAND 1850-2170 MHz)

SBTGA-400TV-AV

ELECTRICAL SPECIFICATIONS

3 X BAND 850

3 X BAND 1850-2170 MHz

Antenna Model	SBTGA-400TV-AV								
Polarization	± 45°								
Frequency	3 X (824 – 896)			3 X (1850 – 2170)					
	824 - 896			1850 - 1990			1920 - 2170		
Horizontal Beamwidth	69°			63°			61°		
Vertical Beamwidth	14.6°			6.6°			6.3°		
Gain (dBi)	T0	T5	T10	T0	T4	T8	T0	T4	T8
	14	13.5	13.5	17	17.5	17	17.5	17.5	17
Vertical Electrical Tilt	VARIABLE 0°-10°			VARIABLE 0°-10°			VARIABLE 0°-10°		
Variable Azimuth*	-10° to +10°								
Upper Sidelobe Suppression for the 1 st lobe above main beam (dB)	T0	T5	T10	T0	T5	T10	T0	T5	T10
	17	17	15	19	17	15	19	17	17
Front-to-Back Ratio /Cpol @ ± 20° (dB)	> 30			> 30			> 30		
VSWR	< 1.5 : 1			< 1.5 : 1			< 1.5 : 1		
Cross Polar Ratio @ 180° ± 20° (dB) <i>Typically</i>	> 10			> 10			> 10		
Isolation between Ports (dB)	> 30			> 30			> 30		
Interband Isolation (dB)	> 40 (824-896//1850-2170)								
Maximum Power Per Input (W)	500			250					
Intermodulation (dBc)	< - 150								
Impedance (Ω)	50								

3 X (Band 850 + Band 1850 - 2170)		
824 - 896	1850 - 2170	
824 - 896	1850-1990	1920-2170
H69° V14.6°	H63° V6.6°	H61° V6.3°
Variable Tilt 0° - 10°	Variable Tilt 0° - 10°	Variable Tilt 0° - 10°

Tri-Sector configuration

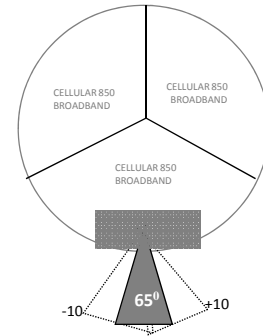

MECHANICAL SPECIFICATIONS

Connectors	12 X 7/16 Female	
Connector Position	Bottom	
Survival Wind Speed	km/h (mph)	200 (125)
Windload	525 (21)	
N @ 160 km/h	(lbs @100 mph)	
Radome Color	Grey, paintable	
Humidity	100%	
Antenna Weight	kg (lbs)	100 (220)
Antenna Dimension	Antenna Size: 1420 X 505 (56 X 20)	
mm (in) H X D	Service Module: 295 X 510 (12 X 20)	

H&V Pattern/ Low band

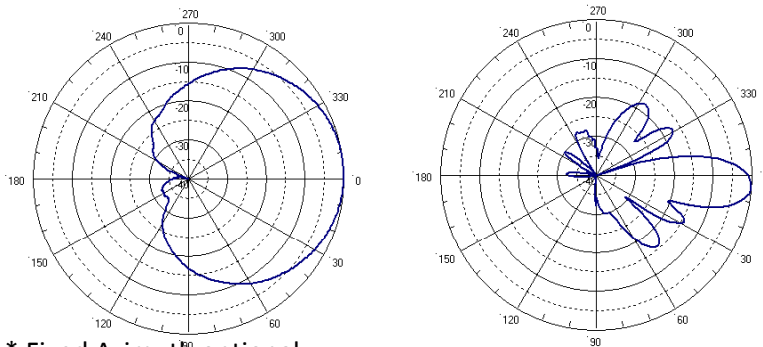

* Fixed Azimuth optional

H&V Pattern/ Broadband

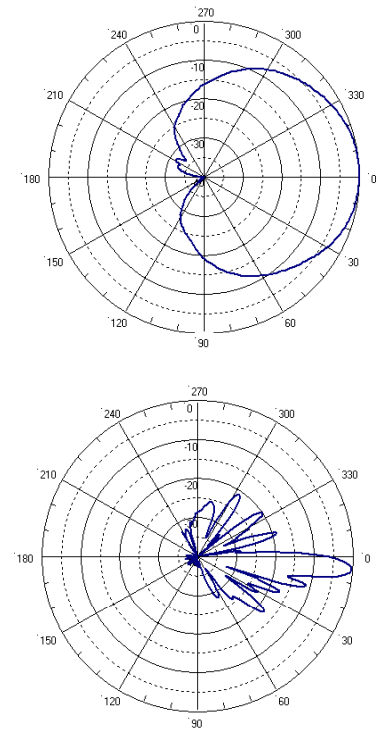

RYMSA Telecom Group (Headquarters)
Ctra. Campo Real, km. 2.100
28500 Arganda del Rey (Madrid)-Spain
Phone : + 34 91 876 06 80
Fax : + 34 91 875 75 32
telecom.commercial@rymsa.com



RYMSA México: telecom.commercial@rymsa.com
Phone: + 52 55 1106 2623
RYMSA Wireless U.S.A: sales@rymsawireless.com
Phone: + 1 888 622 6095
www.rymsawireless.com

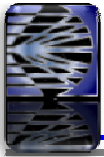

MONO RADOME TRI-SECTOR ANTENNA

3 X (BAND 850 + BAND 1850-2170 MHZ)

3 X (Band 850 + Band 1850 - 2170)		
824 - 896	1850 - 2170	
824 - 896	1850-1990	1920-2170
H69° V7.8°	H63° V6.6°	H61° V6.3°
Variable Tilt 0° - 8°	Variable Tilt 0° - 10°	Variable Tilt 0° - 10°

SBTGA-800TV-AV

ELECTRICAL SPECIFICATIONS

3 X BAND 850

3 X BAND 1850-2170 MHz

Antenna Model	SBTGA-800TV								
Polarization	± 45°								
Frequency	3 X (824 - 896)			3 X (1850 - 2170)					
	824 - 896			1850 - 1990			1920 - 2170		
Horizontal Beamwidth	69°			63°			61°		
Vertical Beamwidth	7.8°			6.6°			6.3°		
Gain (dBi)	T0 16	T4 16.5	T8 16	T0 17	T4 17.5	T8 17	T0 17.5	T4 17.5	T8 17
Vertical Electrical Tilt	VARIABLE 0°-8°			VARIABLE 0°-10°			VARIABLE 0°-10°		
Variable Azimuth *	-10° to +10°								
Upper Sidelobe Suppression for the 1 st lobe above main beam (dB)	T0 20	T4 20	T8 17	T0 19	T4 17	T8 17	T0 18	T4 17	T8 17
Front-to-Back Ratio @ 180° ± 20° (dB)	> 28			> 28			> 28		
VSWR	< 1.5 : 1			< 1.5 : 1			< 1.5 : 1		
Cross Polar Ratio @ ± 60° (dB) <i>Typically</i>	> 8			> 8			> 8		
Isolation between Ports (dB)	> 30			> 30			> 30		
Interband Isolation (dB)	> 40 (824-896//1850-2170)								
Maximum Power Per Input (W)	500			250					
Intermodulation (dBc)	< - 150								
Impedance (Ω)	50								

Tri-Sector configuration

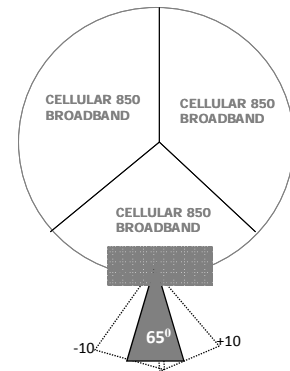

MECHANICAL SPECIFICATIONS

Connectors	12 X 7/16 Female
Connector Position	Bottom
Survival Wind Speed (km/h)	200 (125)
Windload @ 160 km/h (N)	1000 (225)
Radome Color	Grey, paintable
Humidity	100%
Antenna Weight (kg)	150 (330)
Antenna Dimension (mm) H X D	Antenna Size: 2700 X 505 (106 X 20) Service Module: 295 X 510 (12 X 20)

* Fixed Azimuth optional

H&V Pattern/ Low band

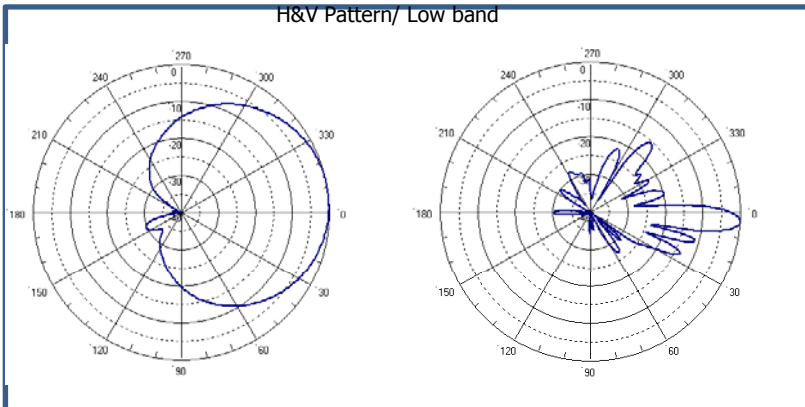

H&V Pattern/ Broadband

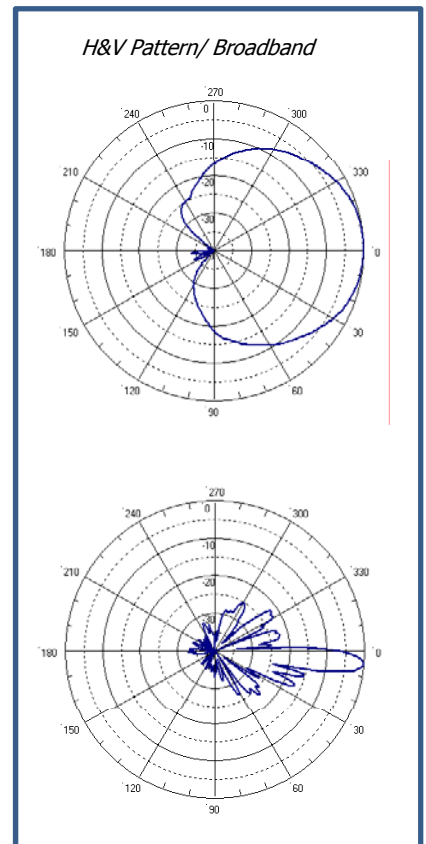



MONO RADOME TRI-SECTOR ANTENNA

DUAL BAND

SBTGA-400TV-AV-EX

3 X (Band 850 + Broadband 1710 - 2170)			
824 - 894	1710 - 2170		
824 - 894	1710-1880	1850-1990	1920-2170
H69° V14.6°	H66° V6.9°	H66° V6.9°	H61° V6.3°
Variable Tilt 0° - 10°	Variable Tilt 0° - 10°	Variable Tilt 0° - 10°	Variable Tilt 0° - 10°

ELECTRICAL SPECIFICATIONS

3 X BAND 850

3 X BROADBAND 1710-2170 MHz

Antenna Model	SBTGA-400TV-AV											
Polarization	± 45°											
Frequency	3 X (824 - 896)			3 X (1710 - 2170)								
	824 - 896	1710 - 1880	1850 - 1990	1920 - 2170								
Horizontal Beamwidth	69°	66°	63°	61°								
Vertical Beamwidth	14.6°	6.9	6.6°	6.3°								
Gain (dBi)	T0	T5	T10	T0	T5	T10	T0	T5	T10	T0	T5	T10
	14	13.5	13.5	17	17.5	17	17	17.5	17	17.5	17.5	17
Vertical Electrical Tilt	VARIABLE 0°-10°			VARIABLE 0°-10°			VARIABLE 0°-10°			VARIABLE 0°-10°		
Variable Azimuth*	-10° to +10°											
Upper Sidelobe Suppression for the 1 st lobe above main beam (dB)	T0	T5	T10	T0	T5	T10	T0	T5	T10	T0	T5	T10
	17	17	15	19	17	17	19	17	15	19	17	17
Front-to-Back Ratio /Cpol @ ± 20° (dB)	> 30			> 30			> 30			> 30		
VSWR	< 1.5 : 1			< 1.5 : 1			< 1.5 : 1			< 1.5 : 1		
Cross Polar Ratio @ 180° ± 20° (dB) Typically	> 10			> 10			> 10			> 10		
	> 30			> 30			> 30			> 30		
Interband Isolation (dB)	> 40 (824-896//1710-2170)											
Maximum Power Per Input (W)	500			250								
Intermodulation (dBc)	< - 150											
Impedance (Ω)	50											

Tri-Sector configuration

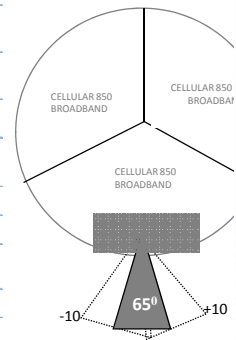

MECHANICAL SPECIFICATIONS

Connectors	12 X 7/16 Female	
Connector Position	Bottom	
Survival Wind Speed	km/h (mph)	200 (125)
Windload	525 (21)	
N @ 160 km/h	(lbs @100 mph)	
Radome Color	Grey, paintable	
Humidity	100%	
Antenna Weight	kg (lbs)	100 (220)
Antenna Dimension	Antenna Size: 1420 X 505 (56 X 20)	
mm (in) H X D	Service Module: 295 X 510 (12 X 20)	

H&V Pattern/ Broadband

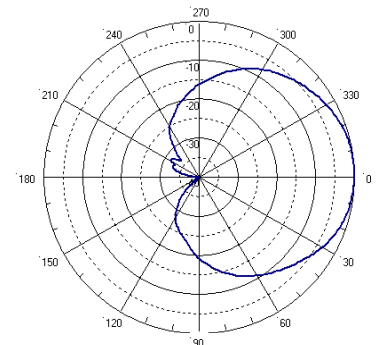

H&V Pattern/ Low band

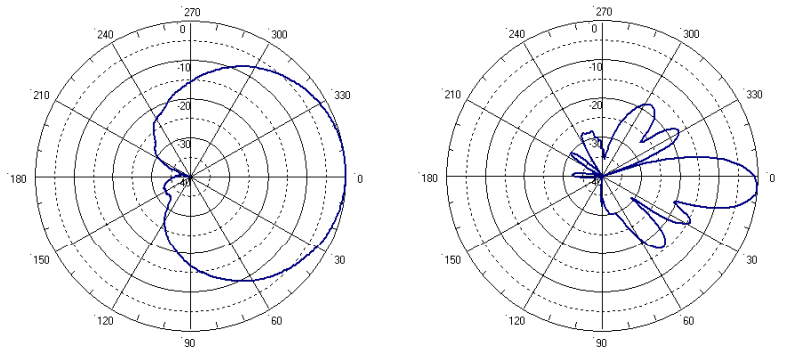

* Fixed Azimuth optional

RYMSA Telecom Group (Headquarters)
 Crtra. Campo Real, km. 2.100
 28500 Arganda del Rey (Madrid)-Spain
 Phone : + 34 91 876 06 80
 Fax : + 34 91 875 75 32
 telecom.commercial@rymsa.com



RYMSA México: telecom.commercial@rymsa.com
 Phone: + 52 55 1106 2623
 RYMSA Wireless U.S.A: sales@rymsawireless.com
 Phone: + 1 888 622 6095
 www.rymsawireless.com

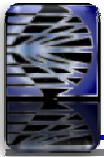

MONO RADOME TRI-SECTOR ANTENNA DUAL BAND

SBTGA-800TV-AV-EX

3 X (Band 850 + Broadband 1710 - 2170)			
824 - 896	1710 - 2170		
824 - 896	1710-1880	1850-1990	1920-2170
H69° V7.8°	H66° V6.9°	H63° V6.6°	H61° V6.3°
Variable Tilt 0° - 8°	Variable Tilt 0° - 10°	Variable Tilt 0° - 10°	Variable Tilt 0° - 10°

ELECTRICAL SPECIFICATIONS

3 X BAND 850

3 X BROADBAND 1710-2170 MHz

Antenna Model	SBTGA-800TV-AV-EX											
Polarization	± 45°											
Frequency	3 X (824 - 896)			3 X (1710 - 2170)								
	824 - 896	1710 - 1880	1850 - 1990	1920 - 2170								
Horizontal Beamwidth	69°			66°			63°			61°		
Vertical Beamwidth	7.8°			6.9			6.6°			6.3°		
Gain (dBi)	T0	T4	T8	T0	T4	T8	T0	T4	T8	T0	T4	T8
	16	16.5	16	17	17.5	17	17	17.5	17	17.5	17.5	17
Vertical Electrical Tilt	VARIABLE 0°-8°			VARIABLE 0°-10°			VARIABLE 0°-10°			VARIABLE 0°-10°		
Variable Azimuth *	-10° to +10°											
Upper Sidelobe Suppression for the 1 st lobe above main beam (dB)	T0	T4	T8	T0	T4	T8	T0	T4	T8	T0	T4	T8
	20	20	17	18	17	17	19	17	17	18	17	17
Front-to-Back Ratio @ 180° ± 20° (dB)	> 28			> 27			> 28			> 28		
VSWR	< 1.5 : 1			< 1.5 : 1			< 1.5 : 1			< 1.5 : 1		
Cross Polar Ratio @ ± 60° (dB)	> 8			> 8			> 8			> 8		
Isolation between Ports (dB)	> 30			> 30			> 30			> 30		
Interband Isolation (dB)	> 40 (824-896//1710-2170)											
Maximum Power Per Input (W)	500			250								
Intermodulation (dBc)	< - 150											
Impedance (Ω)	50											

Tri-Sector configuration

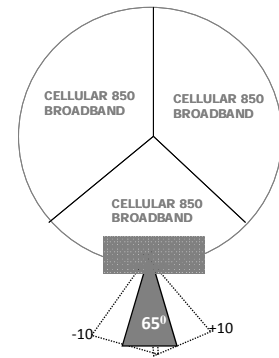

MECHANICAL SPECIFICATIONS

Connectors	12 X 7/16 Female
Connector Position	Bottom
Survival Wind Speed (km/h)	200 (125)
Windload @ 160 km/h (N)	1000 (225)
Radome Color	Grey, paintable
Humidity	100%
Antenna Weight (kg)	150 (331)
Antenna Dimension (mm) H X Diam	Antenna Size: 2700 X 505 (106 X 20) Service Module: 295 X 510 (12 X 20)

* Fixed Azimuth optional

H&V Pattern/ Low band

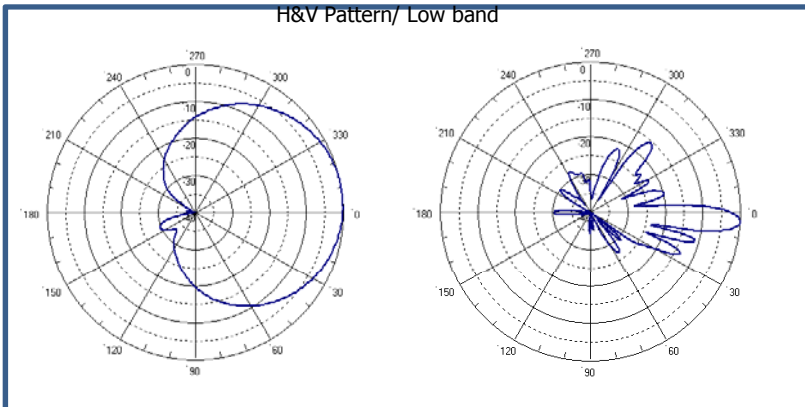

H&V Pattern/ Broadband

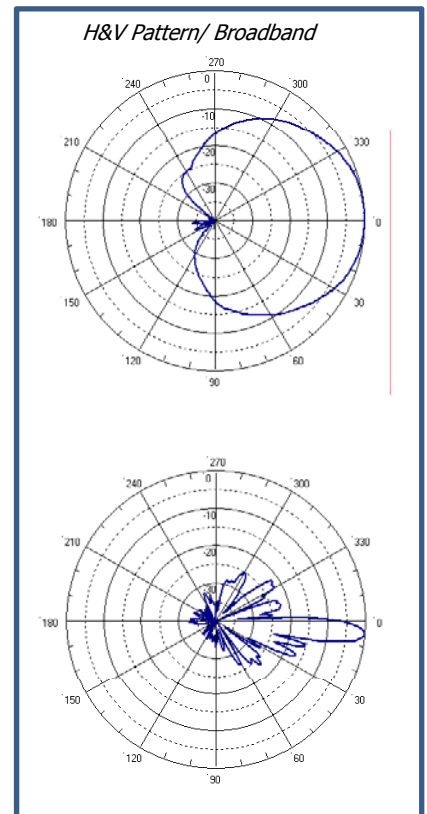

RYMSA Telecom Group (Headquarters)
Crtra. Campo Real, km. 2.100
28500 Arganda del Rey (Madrid)-Spain
Phone : + 34 91 876 06 80
Fax : + 34 91 875 75 32
telecom.commercial@rymsa.com



RYMSA México: telecom.commercial@rymsa.com
Phone: + 52 55 1106 2623
RYMSA Wireless U.S.A: sales@rymsawireless.com
Phone: + 1 888 622 6095
www.rymsawireless.com



MONO RADOME TRI-SECTOR ANTENNA DUAL BAND

SBTG-400TV-AV

* Tentative specs.

3 X (Band 900 + Broadband 1710 - 2170)			
870 - 960	1710 - 2170		
870 - 960	1710-1880	1850-1990	1920-2170
H67° V14°	H65° V6.9°	H63° V6.6°	H60° V6.3°
Variable Tilt 0° - 10°	Variable Tilt 2° - 10°	Variable Tilt 2° - 12°	Variable Tilt 2° - 10°

ELECTRICAL SPECIFICATIONS

3 X BAND 900

3 X BROADBAND 1710 - 2170 MHz

Antenna Model	SBTG-400TV-AV			
	± 45°			
Polarization	± 45°			
	3 X (870 - 960)		3 X (1710 - 2170)	
Frequency	870 - 960	1710 - 1880	1850 - 1990	1920 - 2170
Horizontal Beamwidth	67°	65°	63°	60°
Vertical Beamwidth	14°	6.9°	6.6°	6.3°
Gain (dBi)	T0 T5 T10	T0 T4 T8	T0 T4 T8	T0 T4 T8
	14.5 14.5 14.5	17.5 17.5 17	17.5 17.5 17	18 18 17.5
Vertical Electrical Tilt	VARIABLE			
	0°-10°	2°-10°	2°-10°	2°-10°
Variable Azimuth *	-10° to +10°			
Upper Sidelobe Suppression for the 1 st lobe above main beam (dB)	T0 T5 T10	T0 T4 T8	T0 T4 T8	T0 T4 T8
	15 15 15	17 17 16	17 17 16	17 17 16
Front-to-Back Ratio @ 180° ± 20° (dB)	> 26	> 30	> 30	> 30
VSWR	< 1.5 : 1	< 1.5 : 1	< 1.5 : 1	< 1.5 : 1
Cross Polar Ratio @ ± 60° (dB)	> 8	> 8	> 8	> 8
Isolation between Ports (dB)	> 30	> 30	> 30	> 30
Interband Isolation (dB)	> 35 (870-960//1710-2170)			
Maximum Power Per Input (W)	500	250		
Intermodulation (dBc)	< - 150			
Impedance (Ω)	50			

Tri-Sector configuration
with Variable Azimuth

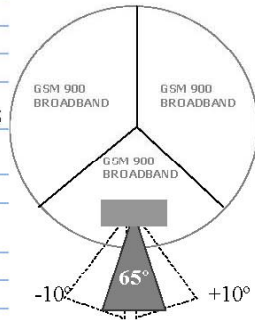

MECHANICAL SPECIFICATIONS

Connectors	12 X 7/16 Female
Connector Position	Bottom
Survival Wind Speed km/h (mph)	200 (125)
Windload	525 (118)
N @ 160 km/h (lbs @100 mph)	
Radome Color	Grey, paintable
Humidity	100%
Antenna Weight kg (lbs)	100 (220)
Antenna Dimension mm (in) H X Diam	Antenna Size: 1420 x 505 (56 X 20) Service Module: 295 x 510 (12 X 20)

H&V Pattern/ Broadband

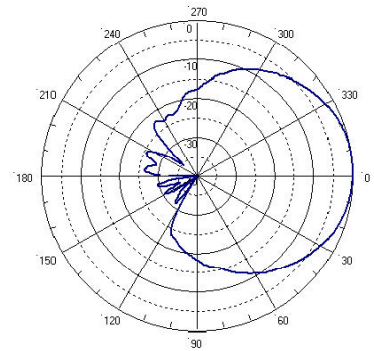

H&V Pattern/ Low band

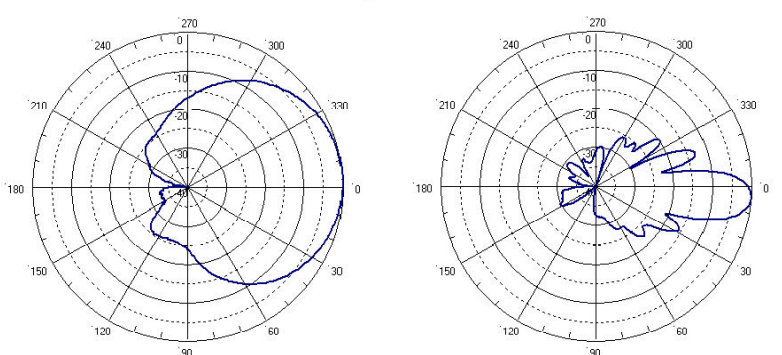

* Fixed Azimuth optional

RYMSA Telecom Group (Headquarters)
Crtra. Campo Real, km. 2.100
28500 Arganda del Rey (Madrid)-Spain
Phone : +34 91 676 06 80
Fax : +34 91 675 75 32
telecom.commercial@rymsa.com

RYMSA
TELECOM GROUP
www.rymsa.com

RYMSA México: telecom.commercial@rymsa.com
Phone:+ 52 55 1106 2623
RYMSA Wireless U.S.A.: sales@rymsawireless.com
Phone: +1 888 622 6095
www.rymsawireless.com



MONO RADOME TRI-SECTOR ANTENNA

DUAL BAND

SBTG-600TV-AV

3 X (Band 900 + Broadband 1710 - 2170)			
870 - 960	1710 - 2170		
870 - 960	1710-1880	1850-1990	1920-2170
H63° V10.5°	H64° V6.8°	H62° V6.5°	H60° V6.3°
Variable Tilt 0° - 10°	Variable Tilt 2° - 10°	Variable Tilt 2° - 10°	Variable Tilt 2° - 10°

ELECTRICAL SPECIFICATIONS

3 X BAND 900

3 X BROADBAND 1710 - 2170 MHz

Antenna Model	SBTG-600TV-AV											
Polarization	± 45°											
Frequency	3 X (870 - 960)				3 X (1710 - 2170)							
	870 - 960			1710 - 1880			1850 - 1990			1920 - 2170		
Horizontal Beamwidth	63°			64°			62°			60°		
Vertical Beamwidth	10.5°			6.8°			6.5°			6.3°		
Gain (dBi)	T0	T5	T10	T2	T6	T10	T2	T6	T10	T2	T6	T10
	15	15.5	15.5	17	17	17.5	17.5	18	17.5	17.5	18	17.5
Vertical Electrical Tilt	VARIABLE 0°-10°			VARIABLE 2°-10°			VARIABLE 2°-10°			VARIABLE 2°-10°		
Variable Azimuth*	-10° to +10°											
Upper Sidelobe Suppression for the 1 st lobe above main beam (dB)	T0	T5	T10	T2	T6	T10	T2	T6	T10	T2	T6	T10
	19	17	15	19	17	15	19	17	17	19	17	17
Front-to-Back Ratio @ 180° ± 20° (dB)	> 27			> 28			> 28			> 28		
VSWR	< 1.5 : 1			< 1.5 : 1			< 1.5 : 1			< 1.5 : 1		
Cross Polar Ratio @ 180° ± 20° (dB)	> 8			> 8			> 8			> 8		
Isolation between Ports (dB)	> 30			> 30			> 30			> 30		
Interband Isolation (dB)	> 35 (870-960//1710-2170)											
Maximum Power Per Input (W)	500			250								
Intermodulation (dBc)	< - 150											
Impedance (Ω)	50											

Tri-Sector configuration
with Variable Azimuth

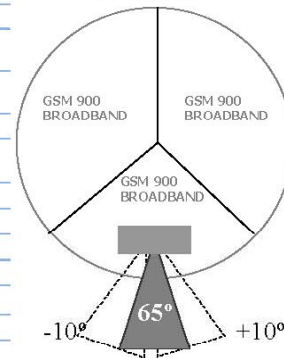

MECHANICAL SPECIFICATIONS

Connectors	12 X 7/16 Female	
Connector Position	Bottom	
Survival Wind Speed	km/h (mph)	200 (125)
Windload	770 (174)	
N @ 160 km/h	(lbs @100 mph)	
Radome Color	Grey, paintable	
Humidity	100%	
Antenna Weight	kg (lbs)	98 (216)
Antenna Dimension	Antenna Size: 2045 x 507 (81 X 20)	
mm (in) H X Diam	Service Module: 390 x 510 (15 X 20)	

H&V Pattern/ Broadband

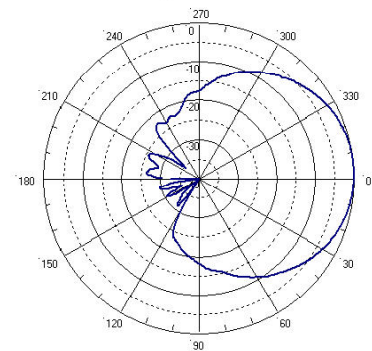

H&V Pattern/ Low band

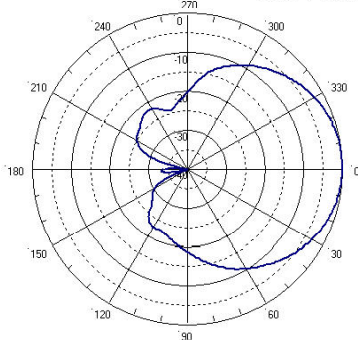

* Fixed Azimuth optional

RYMSA Telecom Group (Headquarters)
 Crtra. Campo Real, km. 2,100
 28500 Arganda del Rey (Madrid)-Spain
 Phone : +34 91 876 06 80
 Fax : +34 91 875 76 32
 telecom.commercial@rymsa.com

RYMSA
 TELECOM GROUP
 www.rymsa.com

RYMSA México: telecom.commercial@rymsa.com
 Phone: +52 55 1106 2623
RYMSA Wireless U.S.A.: sales@rymsawireless.com
 Phone: +1 888 622 6095
 www.rymsawireless.com



MONO RADOME TRI-SECTOR ANTENNA

DUAL BAND

SBTG-800TV-AV

3 X (Band 900 + Broadband 1710 - 2170)			
870 - 960	1710 - 2170		
870 - 960	1710-1880	1850-1990	1920-2170
H65° V7.5°	H65° V6.8°	H63° V6.6°	H60° V6.3°
Variable Tilt 0° - 10°	Variable Tilt 2° - 10°	Variable Tilt 2° - 12°	Variable Tilt 2° - 12°

ELECTRICAL SPECIFICATIONS

3 X BAND 900

3 X BROADBAND 1710 - 2170 MHz

Antenna Model	SBTG-800TV-AV												
Polarization	± 45°												
Frequency	3 X (870 - 960)			3 X (1710 - 2170)									
	870 - 960	1710 - 1880	1850 - 1990	1920 - 2170									
Horizontal Beamwidth	65°	65°	63°	60°									
Vertical Beamwidth	7.5°	6.8°	6.6°	6.3°									
Gain (dBi)	T2 T6 T10	T2 T6 T10	T2 T6 T10	T2 T6 T10									
	16.5 16 16	17.5 17.5 17	17.5 17.5 17	18 18 17.5									
Vertical Electrical Tilt	VARIABLE			VARIABLE			VARIABLE			VARIABLE			
	2°-10°			2°-10°			2°-10°			2°-10°			
Variable Azimuth *	-10° to +10°												
Upper Sidelobe Suppression for the 1 st lobe above main beam (dB)	T2 T6 T10	T2 T6 T10	T2 T6 T10	T2 T6 T10									
	19 17 15	18 17 15	19 17 15	19 17 15									
Front-to-Back Ratio /Cpol @ ± 20° (dB)	> 30			> 30			> 30			> 30			
VSWR	< 1.5 : 1			< 1.5 : 1			< 1.5 : 1			< 1.5 : 1			
Cross Polar Ratio @ 180° ± 20° (dB) Typically	> 7			> 10			> 10			> 10			
	> 25			> 27			> 27			> 30			
Interband Isolation (dB)	> 40 (870-960//1710-2170)												
Maximum Power Per Input (W)	500			250									
Intermodulation (dBc)	< - 150												
Impedance (Ω)	50												

Tri-Sector
configuration
with Variable
Azimuth

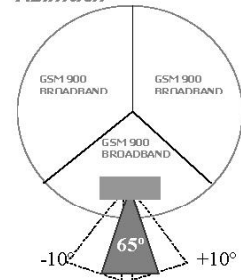

MECHANICAL SPECIFICATIONS

Connectors	12 X 7/16 Female
Connector Position	Bottom
Survival Wind Speed km/h (mph)	200 (125)
Windload N @ 160 km/h (lbs @100 mph)	1000 (225)
Radome Color	Grey, paintable
Humidity	100%
Antenna Weight kg (lbs)	160 (353)
Antenna Dimension mm (in) H X Diam	Antenna Size: 2700 x 505 (106 X 20) Service Module: 295 x 510 (12 X 20)

H&V Pattern/ Broadband

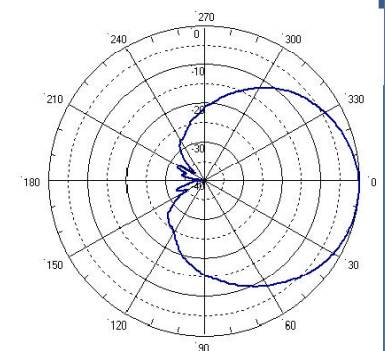

H&V Pattern/ Low band

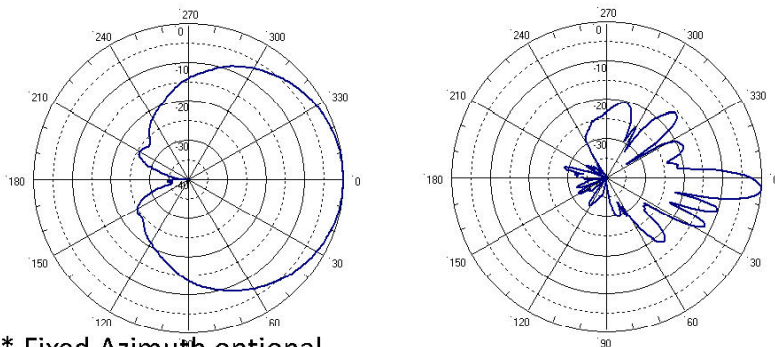

* Fixed Azimuth optional

RYMSA Telecom Group (Headquarters)
 Ctra. Campo Real, km. 2.100
 28500 Arganda del Rey (Madrid)-Spain
 Phone : +34 91 676 06 80
 Fax : +34 91 676 76 32
 telecom.commercial@rymsa.com

RYMSA
 TELECOM GROUP
 www.rymsa.com

RYMSA México: telecom.commercial@rymsa.com
 Phone:+ 52 55 1106 2623
RYMSA Wireless U.S.A.: sales@rymsawireless.com
 Phone: +1 888 622 6095
 www.rymsawireless.com

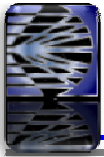

MONO RADOME TRI-SECTOR ANTENNA

TRIPLE-BAND

TRI-SECTOR ANTENNA												
TRIPLE BAND												
3 X (BAND 900 + 2X BROADBAND 1710 - 2170 MHz)												
	Frequency	HBW	VBW	Gain (dbi)	Polarization	Tilt	Radome	Azimuth	Height	mm (in)	Model	Page
3 X 870 - 960	870 - 960	65°	15°	14.5	± 45°	Variable 0°- 10°	Mono-Radome	Variable	Antenna Size: 1420 X 505 (56 X 20) Service Module: 295 X 510 (12 X 20)	SBTT-400TV-AV	128	
3 X 1710 - 2170	1710 - 1880	65°	6°	17.5	± 45°	Variable 2°- 10°						
	1850 - 1990	65°	6°	17.5		Variable 2°- 10°						
	1920 - 2170	65°	6°	18		Variable 2°- 10°						
3 X 870 - 960	870 - 960	65°	10°	15.5	± 45°	Variable 0°- 10°	Mono-Radome	Variable	Antenna Size: 2045 X 505 (81 X 20) Service Module: 390 X 510 (15 X 20)	SBTT-600TV-AV	129	
3 X 1710 - 2170	1710 - 1880	65°	6°	17	± 45°	Variable 2°- 10°						
	1850 - 1990	65°	6°	17.5		Variable 2°- 10°						
	1920 - 2170	65°	6°	18		Variable 2°- 10°						
3 X 870 - 960	870 - 960	65°	6°	16	± 45°	Variable 2°- 10°	Mono-Radome	Variable	Antenna Size: 2700 X 505 (106 X 20) Service Module: 295 X 510 (12 X 20)	SBTT-800TV-AV	130	
3 X 1710 - 2170	1710 - 1880	65°	6°	17.5	± 45°	Variable 2°- 10°						
	1850 - 1990	65°	6°	17.5		Variable 2°- 10°						
	1920 - 2170	65°	6°	18		Variable 2°- 10°						

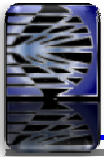

MONO RADOME TRI-SECTOR ANTENNA

3 X (BAND 900 + 2 X BROADBAND 1710-2170 MHz)

SBTT-400TV-AV

3 X (Band 900 + 2 X Broadband 1710 - 2170)			
870 - 960	2 X 1710 - 2170		
870 - 960	1710-1880	1850-1990	1920-2170
H67° V14°	H65° V6.9°	H63° V6.6°	H60° V6.3°
Variable Tilt 0° - 10°	Variable Tilt 2° - 10°	Variable Tilt 2° - 10°	Variable Tilt 2° - 10°

ELECTRICAL SPECIFICATIONS

Antenna Model	SBTT-400TV-AV											
Polarization	± 45°											
Frequency	3 X (870 - 960)			3 X (2 X 1710 - 2170)								
	870 - 960	1710 - 1880	1850 - 1990	1920 - 2170								
Horizontal Beamwidth	67°			65°			63°			60°		
Vertical Beamwidth	14°			6.9°			6.6°			6.3°		
Gain (dBi)	T0	T5	T10	T0	T5	T10	T0	T5	T10	T0	T5	T10
	14.5	14.5	14.5	17.5	17.5	17	17.5	17.5	17	18	18	17.5
Vertical Electrical Tilt	VARIABLE 0°-10°			VARIABLE 2°-10°			VARIABLE 2°-10°			VARIABLE 2°-10°		
Variable Azimuth*	-10° to +10°											
Upper Sidelobe Suppression for the 1 st lobe above main beam (dB)	T0	T5	T10	T0	T5	T10	T0	T5	T10	T0	T5	T10
	15	15	15	17	17	16	17	17	16	17	17	16
Front-to-Back Ratio @ 180° ± 20° (dB)	> 26			> 30			> 30			> 30		
VSWR	< 1.5 : 1			< 1.5 : 1			< 1.5 : 1			< 1.5 : 1		
Cross Polar Ratio @ ± 60° (dB)	> 8			> 8			> 8			> 8		
Isolation between Ports (dB)	> 30			> 30			> 30			> 30		
Interband Isolation (dB)	> 40 (870-960//1710-2170) > 30 (1710-2170//1710-2170)											
Maximum Power Per Input (W)	500			250								
Intermodulation (dBc)	< - 150											
Impedance (Ω)	50											

Tri-Sector
configuration
with Variable
Azimuth

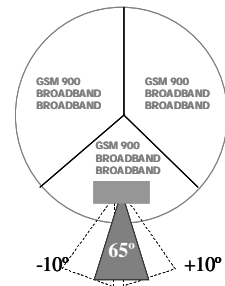

MECHANICAL SPECIFICATIONS

Connectors	18 X 7/16 Female
Connector Position	Bottom
Survival Wind Speed km/h (mph)	200 (125)
Windload	525 (118)
N @ 160 km/h (lbs @100 mph)	
Radome Color	Grey, paintable
Humidity	100%
Antenna Weight kg (lbs)	105 (231)
Antenna Dimension mm (in) H X W X D	Antenna Size: 1420 X 505 (56 X 20) Service Module : 295 X 510 (12 X 20)

H&V Pattern/ Broadband

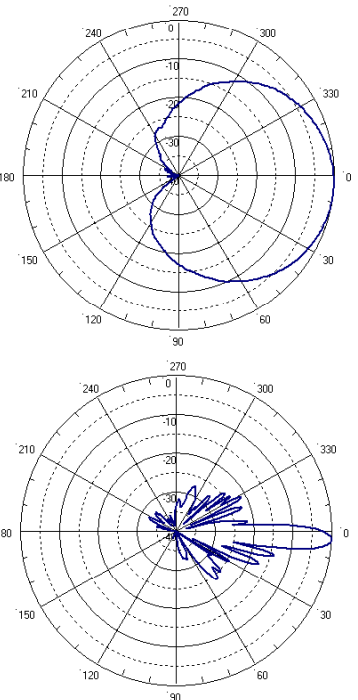

H&V Pattern/ Low band

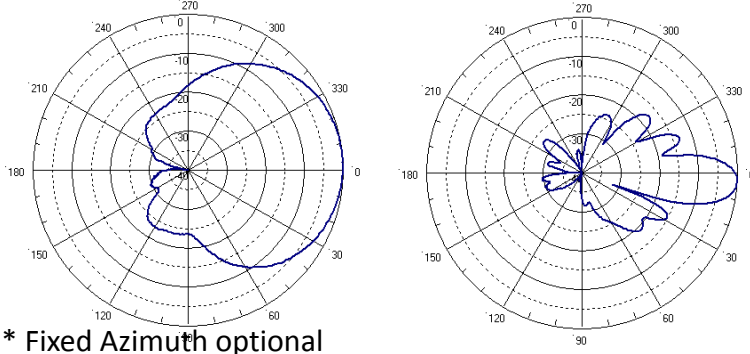

* Fixed Azimuth optional

RYMSA Telecom Group (Headquarters)
Ctra. Campo Real, km. 2.100
28500 Arganda del Rey (Madrid)-Spain
Phone : + 34 91 876 06 80
Fax : + 34 91 875 75 32
telecom.commercial@rymsa.com



RYMSA México: telecom.commercial@rymsa.com
Phone: + 52 55 1106 2623
RYMSA Wireless U.S.A: sales@rymsawireless.com
Phone: + 1 888 622 6095
www.rymsawireless.com

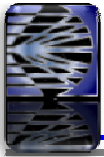

MONO RADOME TRI-SECTOR ANTENNA

3 X (BAND 900 + 2 X BROADBAND 1710-2170 MHZ)

SBTT-600TV-AV

3 X (Band 900 + 2 X Broadband 1710 - 2170)			
870 - 960	2 X 1710 - 2170		
870 - 960	1710-1880	1850-1990	1920-2170
H63° V10.5°	H64° V6.8°	H62° V6.5°	H60° V6.3°
Variable Tilt 0° - 10°	Variable Tilt 2° - 10°	Variable Tilt 2° - 10°	Variable Tilt 2° - 10°

ELECTRICAL SPECIFICATIONS

3 X BAND 900

3 X (2 X BROADBAND 1710 - 2170 MHz)

Antenna Model	SBTT-600TV-AV											
Polarization	± 45°											
Frequency	3 X (870 X 960)			3 X (2 X 1710 - 2170)								
	870 - 960	1710 - 1880	1850 - 1990	1920 - 2170								
Horizontal Beamwidth	63°			64°			62°			60°		
Vertical Beamwidth	10.5°			6.8°			6.5°			6.3°		
Gain (dBi)	T0 15	T5 15.5	T10 15.5	T2 16.5	T6 17	T10 17	T2 17.5	T6 17.5	T10 17.5	T2 17.5	T6 18	T10 17.5
Vertical Electrical Tilt	VARIABLE 0°-10°			VARIABLE 2°-10°			VARIABLE 2°-10°			VARIABLE 2°-10°		
Variable Azimuth*	-10° to +10°											
Upper Sidelobe Suppression for the 1 st lobe above main beam (dB)	T0 19	T5 17	T10 15	T2 19	T6 17	T10 15	T2 19	T6 17	T10 17	T2 19	T6 17	T10 17
Front-to-Back Ratio @ 180° ± 20° (dB)	> 27			> 27			> 27			> 27		
VSWR	< 1.5 : 1			< 1.5 : 1			< 1.5 : 1			< 1.5 : 1		
Cross Polar Ratio @ ± 60° (dB) <i>Typically</i>	> 8			> 8			> 8			> 10		
Isolation between Ports (dB)	> 30			> 30			> 30			> 30		
Interband Isolation (dB)	> 40 (870-960//1710-2170) > 30 (1710-2170//1710-2170)											
Maximum Power Per Input (W)	500			250								
Intermodulation (dBc)	< - 150											
Impedance (Ω)	50											

Tri-Sector
configuration
with Variable
Azimuth

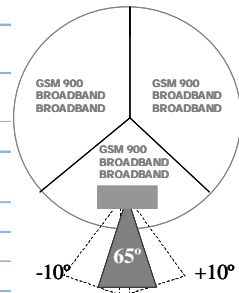

MECHANICAL SPECIFICATIONS

Connectors	18 X 7/16 Female
Connector Position	Bottom
Survival Wind Speed km/h (mph)	200 (125)
Windload N @ 160 km/h (lbs @100 mph)	770 (174)
Radome Color	Grey, paintable
Humidity	100%
Antenna Weight kg (lbs)	98 (216)
Antenna Dimension mm (in) H X Diam	Antenna Size: 2045 X 505 (81 X 20) Service Module: 390 x 510 (15 X 20)

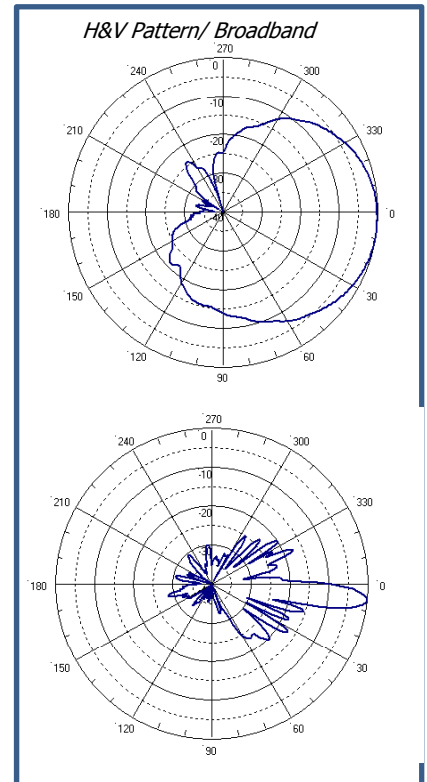
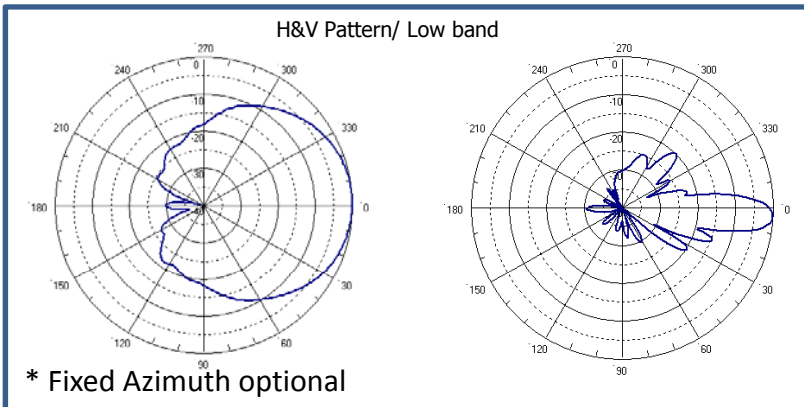

RYMSA Telecom Group (Headquarters)
Crtra. Campo Real, km. 2.100
28500 Arganda del Rey (Madrid)-Spain
Phone : + 34 91 876 06 80
Fax : + 34 91 875 75 32
telecom.commercial@rymsa.com

RYMSA
TELECOM GROUP
www.rymsa.com

RYMSA México: telecom.commercial@rymsa.com
Phone: + 52 55 1106 2623
RYMSA Wireless U.S.A: sales@rymsawireless.com
Phone: + 1 888 622 6095
www.rymsawireless.com



MONO RADOME TRI-SECTOR ANTENNA

3 X (BAND 900 + 2 X BROADBAND 1710-2170 MHz)

SBTT-800TV-AV

ELECTRICAL SPECIFICATIONS

3 X BAND 900

3 X (2 X BROADBAND 1710 - 2170 MHz)

3 X (Band 900 + 2 X Broadband 1710 - 2170)			
870 - 960	2 X 1710 - 2170		
870 - 960	1710-1880	1850-1990	1920-2170
H65° V7.5°	H65° V6.8°	H63° V6.6°	H60° V6.3°
Variable Tilt 2° - 10°	Variable Tilt 2° - 10°	Variable Tilt 2° - 10°	Variable Tilt 2° - 10°

Antenna Model	SBTT-800TV-AV							
Polarization	± 45°							
Frequency	3 X (870 - 960)			3 X (2 X 1710 - 2170)				
	870 - 960	1710 - 1880	1850 - 1990	1920 - 2170				
Horizontal Beamwidth	65°	65°	63°	60°				
Vertical Beamwidth	7.5°	6.8°	6.6°	6.3°				
Gain (dBi)	T2 T6 T10 16.5 16 16	T2 T6 T10 17.5 17.5 17	T2 T6 T10 17.5 17.5 17	T2 T6 T10 18 18 18	17.5			
Vertical Electrical Tilt	VARIABLE 2°-10°			VARIABLE 2°-10°				
Variable Azimuth*	-10° to +10°							
Upper Sidelobe Suppression for the 1 st lobe above main beam (dB)	T2 T6 T10 19 17 15	T2 T6 T10 18 17 15	T2 T6 T10 19 17 15	T2 T6 T10 19 17 15	19 17 15			
Front-to-Back Ratio @ 180° ± 20° (dB)	> 30			> 30				
VSWR	< 1.5 : 1			< 1.5 : 1				
Cross Polar Ratio @ ± 60° (dB) Typically	> 7			> 7				
Isolation between Ports (dB)	> 25			> 27				
Interband Isolation (dB)	> 40 (870-960//1710-2170) > 30 (1710-2170//1710-2170)							
Maximum Power Per Input (W)	500			250				
Intermodulation (dBc)	< - 150							
Impedance (Ω)	50							

Tri-Sector
configuration with
Variable Azimuth

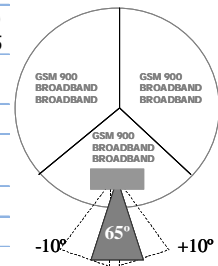

MECHANICAL SPECIFICATIONS

Connectors	18 X 7/16 Female
Connector Position	Bottom
Survival Wind Speed km/h (mph)	200 (125)
Windload N @ 160 km/h (lbs @100 mph)	1000 (225)
Radome Color	Grey, paintable
Humidity	100%
Antenna Weight kg (lbs)	170 (375)
Antenna Dimension mm (in) H X Diam	Antenna Size: 2700 X 505 (106 X 20) Service Module: 295 x 510 (12 X 20)

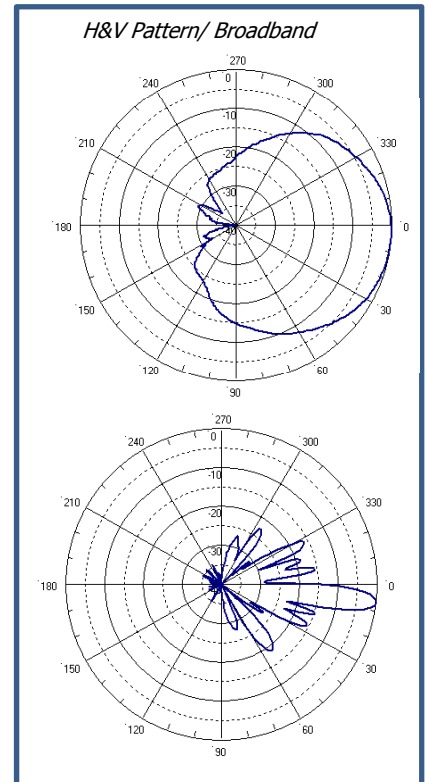
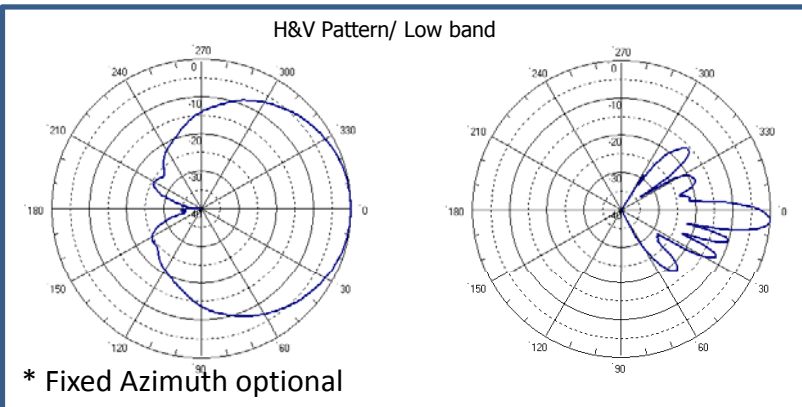

RYMSA Telecom Group (Headquarters)
Ctra. Campo Real, km. 2.100
28500 Arganda del Rey (Madrid)-Spain
Phone : + 34 91 876 06 80
Fax : + 34 91 875 75 32
telecom.commercial@rymsa.com

RYMSA
TELECOM GROUP
www.rymsa.com

RYMSA México: telecom.commercial@rymsa.com
Phone: + 52 55 1106 2623
RYMSA Wireless U.S.A: sales@rymsawireless.com
Phone: + 1 888 622 6095
www.rymsawireless.com

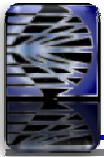

RYMSA FLEXIBLE POLE

RYMSA FLEXIBLE POLE

- Trisector Antenna Mast
- Urban landscape integration
- Tubular and squared poles
- Modularity
- Several anchoring solutions
- Accesibility
- Easy installation
- CAPEX saving
- Devices integration
- Feeders
- Tailored Mechanical calculations available

> URBAN LANDSCAPE INTEGRATION

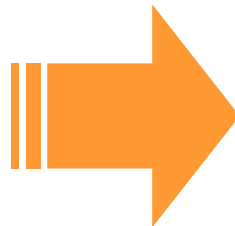
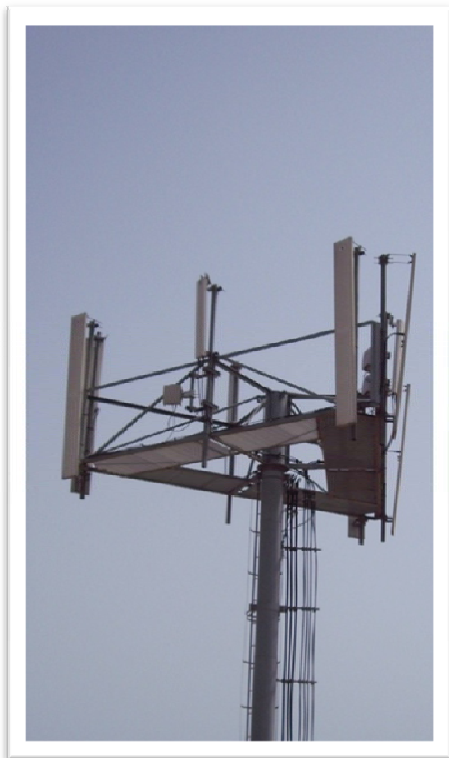

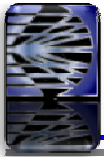

Aesthetical options



> TUBULAR AND SQUARED



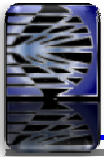

RYMSA FLEXIBLE POLE

> MODULARITY:
from 1 to 9 mtrs

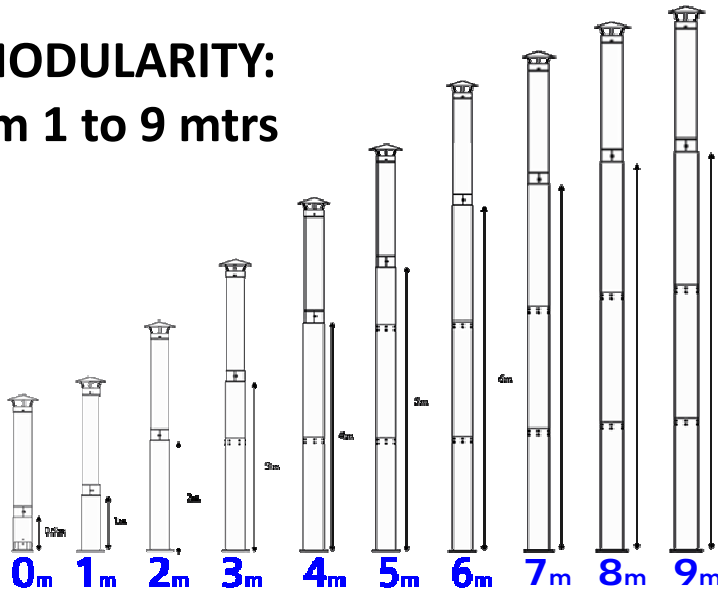

> SEVERAL ANCHORING SOLUTION:

Bedplate

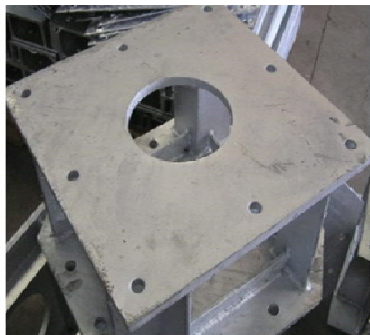
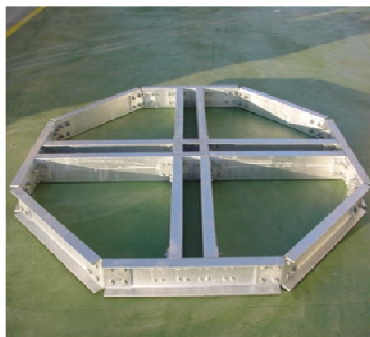

Ground Pillar



Wall Pillar

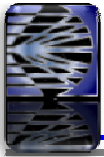

RYMSA FLEXIBLE POLE

> ACCESSIBILITY:



Portable leader



Iron security cable



Folding

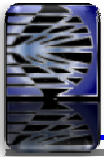

RYMSA FLEXIBLE POLE

> DEVICES INTEGRATION:

Microwave dishes

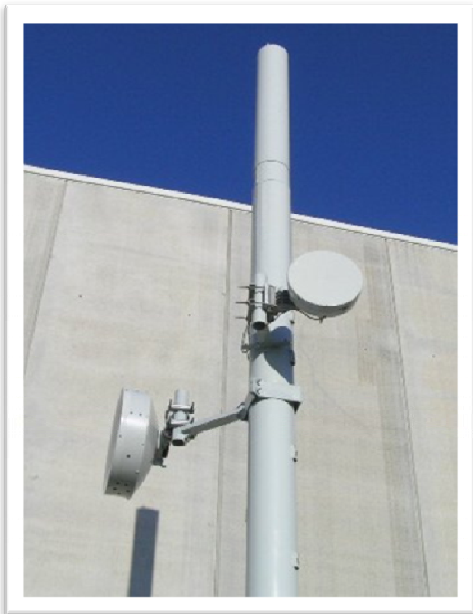

Remote Radio Heads

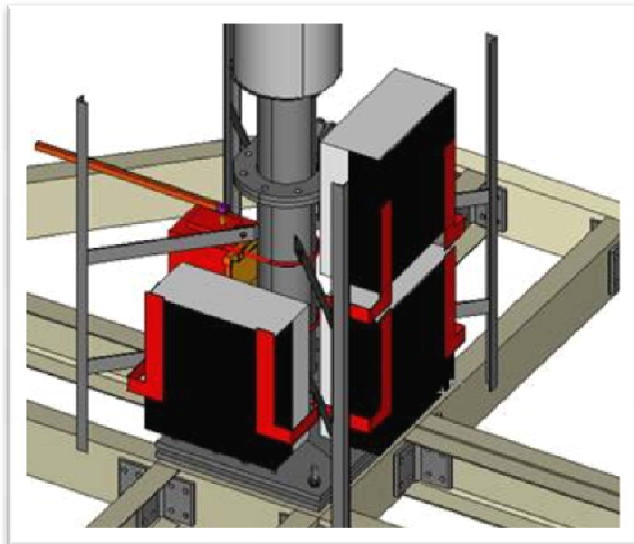

Outdoor BTS
integration

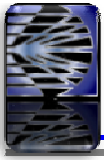

RYMSA FLEXIBLE POLE

> MECHANICAL SPECIFICATIONS:

- **Diameter:** 277 and 355 mm
- **Material:** hot galvanized steel
- **Colours:** on demand
- **Wind Survival:** 200 km/h (125 mph)
- **Max. Top deviation 1° with wind:** 165 km/h (103 mph)

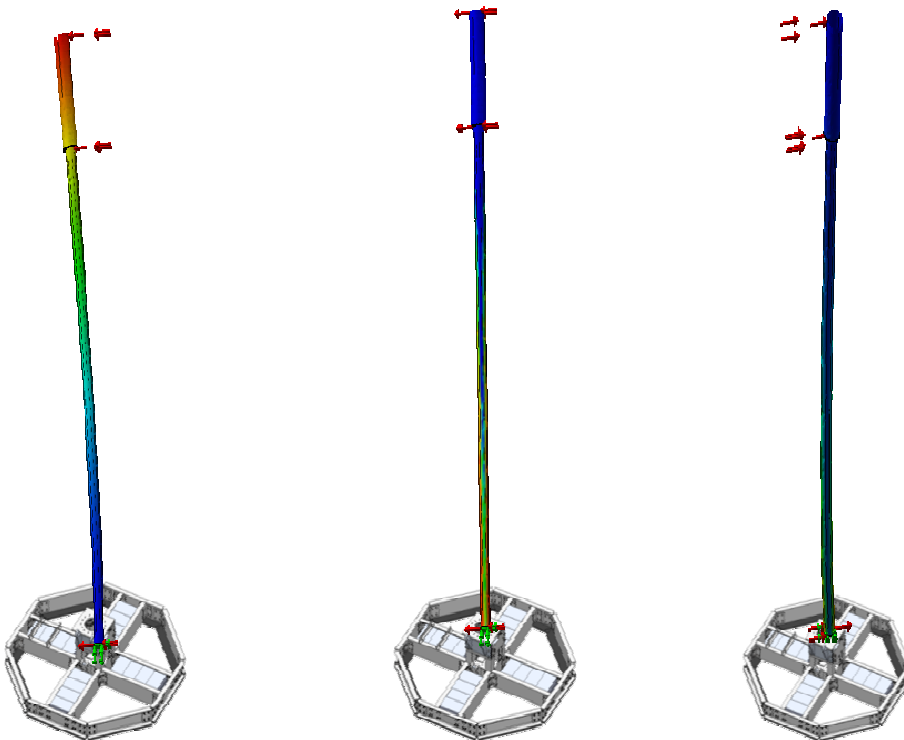

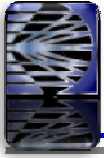

REPEATER

YAGI BAND 900

REPEATER								
YAGI BAND 900								
Frequency	HBW	VBW	Gain (dbi)	Polarization	Tilt	Height (mm)	Model	Page
806 - 960	34°	30°	14	Vertical	Fixed Tilt 0°	740	ATY 40-596	138
806 - 960	60°	55°	10	Vertical	Fixed Tilt 0°	740	ATY 40-506	139

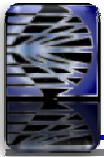

REPEATER

YAGI BAND 900

ATY 40-596

806-960
H34° V30°
Fixed Tilt
0°

ELECTRICAL SPECIFICATIONS

BAND 900

Antenna Model	ATY40-596
Polarization	Vertical
Frequency (MHz)	806 - 960
Horizontal Beamwidth	34°
Vertical Beamwidth	30°
Gain (dBi)	14
Vertical Electrical Tilt	Fixed 0°
Front-to-Back Ratio @ 180° ± 20° (dB)	> 16
VSWR	< 1.5 : 1
Maximum Power Per Input (W)	100
Impedance (Ω)	50

MECHANICAL SPECIFICATIONS

Connectors	1 X N Female	
Connector Position	Antenna rear	
Survival Wind Speed	km/h (mph)	200 (125)
Front Windload		
N @ 160 km/h	(lbs @100 mph)	30 (7)
Lateral Windload		
N @ 160 km/h	(lbs @100 mph)	125 (28)
Humidity		100%
Antenna Weight	kg (lbs)	1 (2)
Antenna Dimension		
mm (in) H X W X D		1380

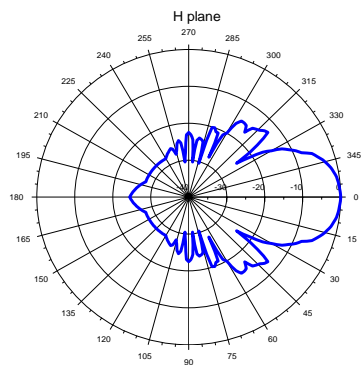
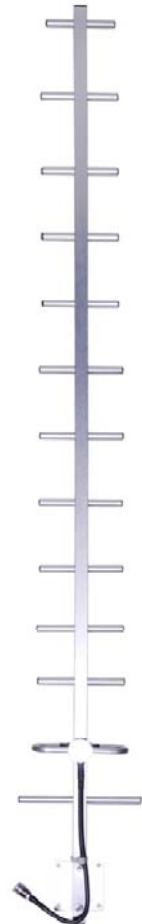

H&V Pattern

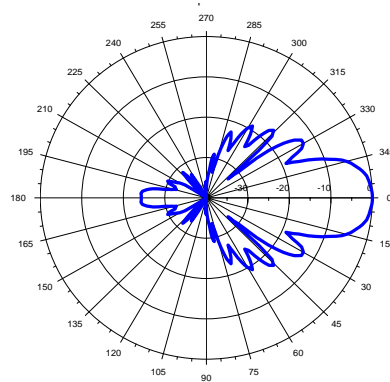

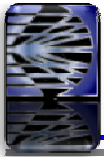

REPEATER

YAGI BAND 900

ATY 40-506

806-960

H60° V55°

Fixed Tilt

0°

ELECTRICAL SPECIFICATIONS

BAND 900

Antenna Model	ATY40-506
Polarization	Vertical
Frequency (MHz)	806 - 960
Horizontal Beamwidth	60°
Vertical Beamwidth	55°
Gain (dBi)	10
Vertical Electrical Tilt	Fixed 0°
Front-to-Back Ratio /Cpol @ ± 20° (dB)	> 15
VSWR	< 1.5 : 1
Maximum Power Per Input (W)	100
Impedance (Ω)	50

MECHANICAL SPECIFICATIONS

Connectors	1 X 7/16 Female
Connector Position	Antenna rear
Survival Wind Speed km/h (mph)	200 (125)
Front Windload N @ 160 km/h (lbs @100 mph)	30 (7)
Lateral Windload N @ 160 km/h (lbs @100 mph)	60 (13)
Humidity	100%
Antenna Weight (kg)	0.8 (2)
Antenna Dimension (mm)	749 (29)

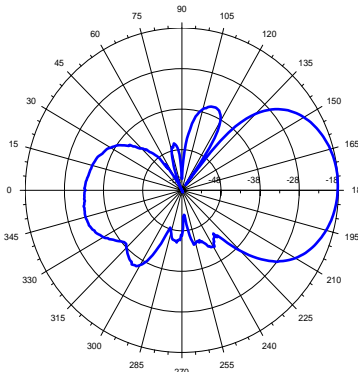
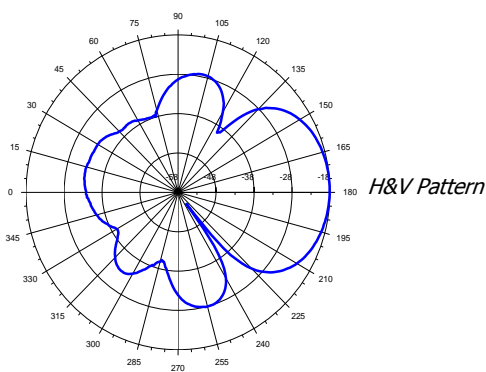

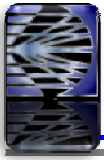

REPEATER

LOG PERIODIC BAND 900

REPEATER							
LOG PERIODIC BAND 900							
Frequency	HBW	VBW	Gain (dbi)	Polarization	Heigh (mm)	Model	Page
806-960	59°	89°	14	Vertical / Horizontal	1380	AT42-169	141

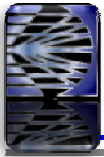

REPEATER

LOG PERIODIC BAND 900

870-960
H59° V89°

AT42-169

ELECTRICAL SPECIFICATIONS

BAND 900

Antenna Model	AT42-169
Polarization	Vertical/Horizontal
Frequency (MHz)	870 - 960
Horizontal Beamwidth	59°
Vertical Beamwidth	89°
Gain (dBi)	8
Front-to-Back Ratio /Cpol @ ± 30° (dB)	> 20
VSWR	< 1.5 : 1
Maximum Power Per Input (W)	20
Impedance (Ω)	50



MECHANICAL SPECIFICATIONS

Connectors AT42-169/2176 *	TNC + 3 m Jumper cable
Connectors AT42-169/3921 *	N female + 0.5 m Jumper
Connector position	Antenna rear
Survival Wind Speed km/h (mph)	200 (125)
Front Windload N @ 160 km/h (lbs @100 mph)	4 (1)
Lateral Windload N @ 160 km/h (lbs @100 mph)	72 (16)
Humidity	100%
Antenna Weight (kg)	1.5
Antenna Dimension (mm)	300 X 250 X 50 (11 X 10 X 2)

* On demand

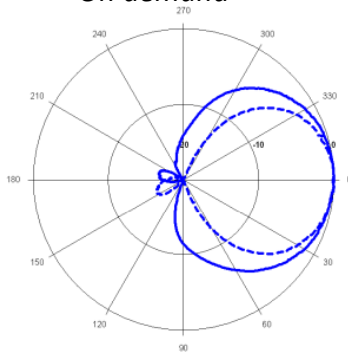

H&V Pattern

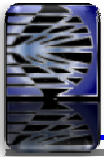

UHF MOBILE ANTENNA

UHF MOBILE ANTENNA							
Frequency	HBW	VBW	Gain (dbi)	Polarization	Height mm (in)	Model	Page
400 - 470	360°	80°	2.1	Vertical	160 (6)	AT30-290	143
DISCONE ANTENNA							
215 - 420	360°	85°	2	Vertical	400 (16)	AT28-420	144

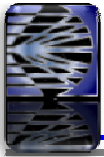

UHF MOBILE ANTENNA

AT30-290

ELECTRICAL SPECIFICATIONS

MOBILE ANTENNA

Antenna Model	AT30-290
Polarization	Vertical
Frequency (MHz)	400-470
Horizontal Beamwidth	360°
Vertical Beamwidth	80°
Gain (dBi)	2.15
VSWR	< 1.5 : 1
Maximum Power Per Input (W)	300
Impedance (Ω)	50

MECHANICAL SPECIFICATIONS

Connectors	N Female
Survival Wind Speed km/h (mph)	200 (125)
Front Windload N @ 160 km/h (lbs @100 mph)	17 (4)
Radome Color	White
Humidity	100%
Antenna Weight kg (lbs)	0.8 (2)
Antenna Dimension mm (in) H X W X D	157 X 145 X 80 (6 X 6 X 3)

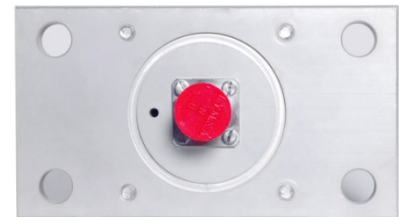



UHF DISCONE ANTENNA

AT28-420

ELECTRICAL SPECIFICATIONS

DISCONE ANTENNA

Antenna Model	AT28-420
Frequency (MHz)	215-420
Horizontal Beamwidth	360°
Vertical Beamwidth	85°
Gain (dBi)	2
VSWR	< 2.0 : 1
Maximum Power Per Input (W)	100
Impedance (Ω)	50

MECHANICAL SPECIFICATIONS

Connectors	N Female
Connector Position	Antenna rear
Survival Wind Speed km/h (mph)	200 (125)
Front Windload N @ 160 km/h (lbs @100 mph)	100 (22)
Lateral Windload N @ 160 km/h (lbs @100 mph)	100 (22)
Radome Color	Anodized aluminium
Humidity	100%
Antenna Weight kg (lbs)	4 (9)
Antenna Dimension mm (in) Diam	400 X 650 (16 X 26)

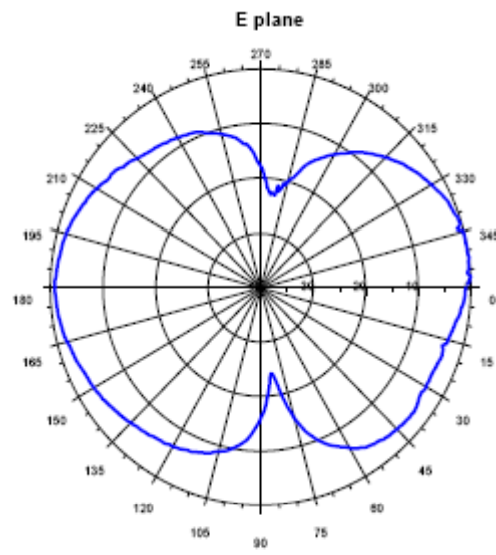
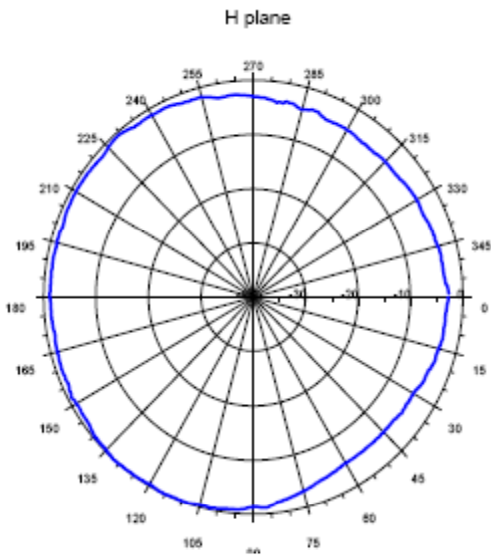

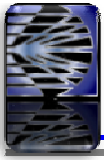

VHF LOADED ANTENNA

VHF LOADED ANTENNA							
Frequency	HBW	VBW	Gain (dbi)	Polarization	Height mm (in)	Model	Page
118 - 150	360°	107°	2	Vertical	1320 (52)	AT23-392	146

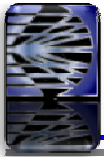

VHF LOADED ANTENNA

AT23-392

ELECTRICAL SPECIFICATIONS

DISCONE ANTENNA

Antenna Model	AT23-392
Polarization	Vertical
Frequency (MHz)	118-150
Horizontal Beamwidth	360°
Vertical Beamwidth	107°
Gain (dBi)	2
VSWR	< 2.0 : 1
Maximum Power Per Input (W)	250
Impedance (Ω)	50

MECHANICAL SPECIFICATIONS

Connectors	N Female	
Connector Position	Antenna rear	
Survival Wind Speed	km/h (mph)	200 (125)
Front Windload		
N @ 160 km/h	(lbs @100 mph)	127 (29)
Lateral Windload		
N @ 160 km/h	(lbs @100 mph)	127 (29)
Humidity		100%
Antenna Weight	kg (lbs)	2.2 (5)
Antenna Dimension		1320 X 290 X 290 (52 X 12 X 12)
mm (in)	H X W X D	

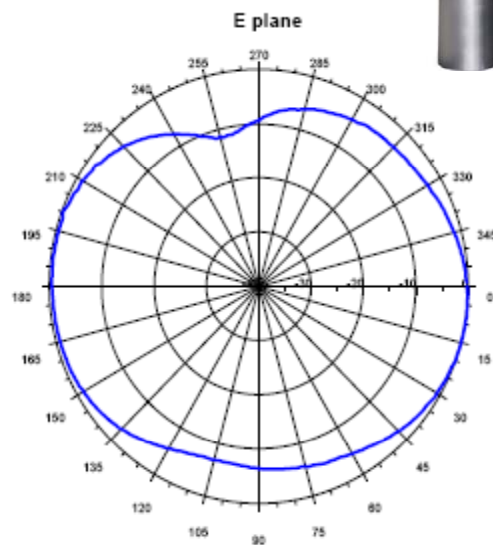
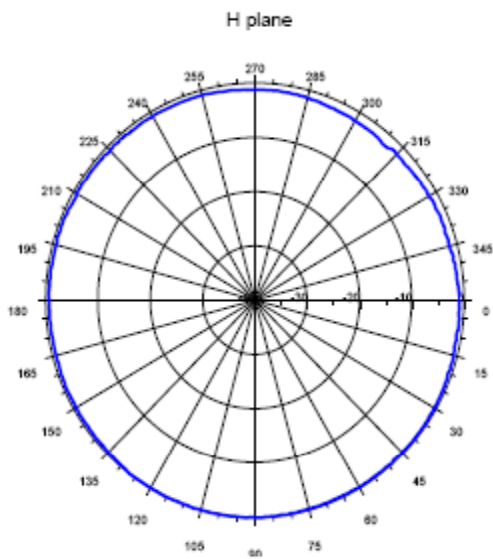

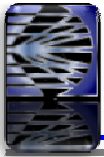

RET SYSTEMS

FOR ELECTRICAL DOWNTILT ANTENNAS

RET SYSTEMS		
For Electrical Downtilt Antennas		
Model	Protocol	Page
RACU (Remote Antenna Control Unit)	AISG 1.1 / AISG 2.0 compliant / Ericsson Protocol	152
SCU (Site Control Unit)	AISG 1.1 and AISG 2.0 compliant	155
Cables	AISG 1.1 and AISG 2.0 compliant	156

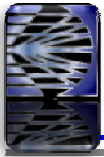

RET SYSTEMS

FOR ELECTRICAL DOWNTILT ANTENNAS

ATTENTION: START THE CALIBRATION PROCESS WITH THE TILT BAR SITUATED AT 2º POSITION. Attaching the RACU with a manual downtilt setting of less than one degree may affect the correct operation of the antenna downtilt mechanism.

Installation instructions

- RACU Unit (Remote Antenna Control Unit)



- Termination load



1. Identification of the mechanical interface of the antenna prepared for RACU.

GENERAL DESCRIPTION OF THE INTERFACE (Protective Cap removed):

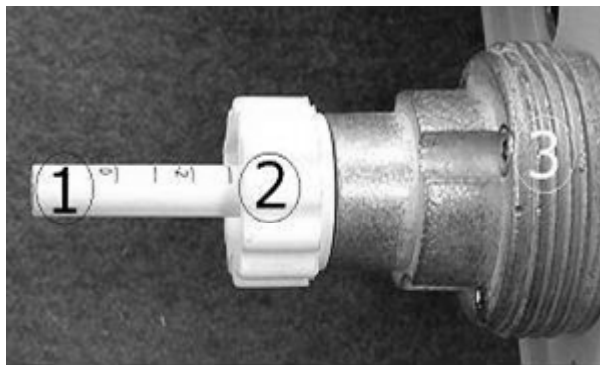

1. Down tilt indicator bar with visual scale
2. Tilt Adjustment Knob
3. This thread fixes the protective cap or the RACU to the Antenna.

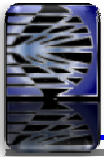

RET SYSTEMS

FOR ELECTRICAL DOWNTILT ANTENNAS

2. Attaching the RACU to the Antenna

2.1 Remove the protective cover of the adjustment tilt mechanism.

2.2 Attach the RACU to the Antenna

Rotate the spindle until the numbers corresponding to tilt setting 3 and 4 are visible.

Place the RACU carefully over the spindle, observing the correct alignment of the RACU with regard to the thread:

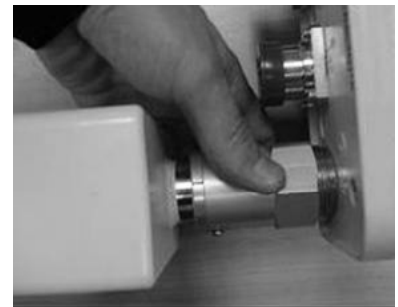
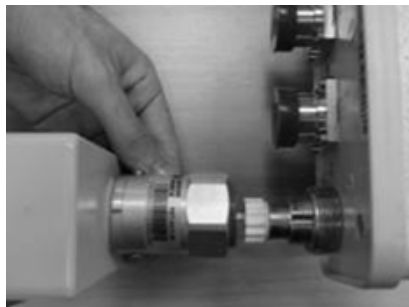
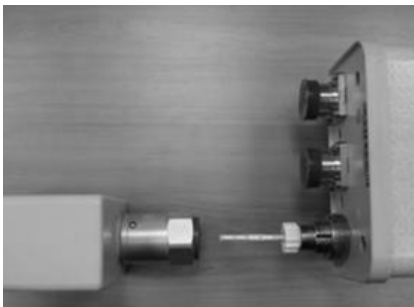
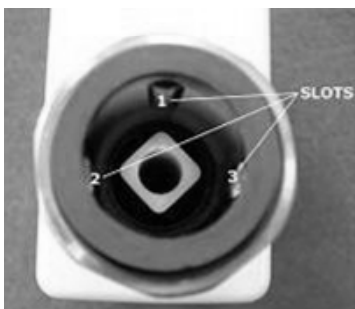

You have to pay attention in matching the three slots inside the RACU with the three notches of the antenna thread.

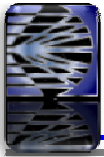

RET SYSTEMS

FOR ELECTRICAL DOWNTILT ANTENNAS

Note: PUSH-UP THE RACU CAREFULLY UNTIL YOU NOTICE THE JOINT MAKES STOP WITH THE THREAD:

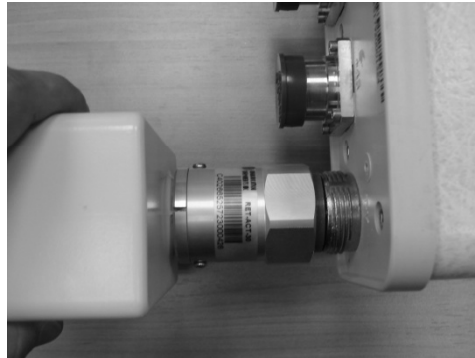

Note: If the RACU will not fully seat itself against the mounting hub on the first attempt, rotate the RACU a slight amount until the square gear drive within the RACU lines up with and slides into the square socket in the adjustment gear wheel. Once this drive mechanism is properly engaged, rotate the RACU back to the correct alignment with the three slots in the mounting hub.

Tighten the RACU attachment nut. You can use a torque-wrench with with 40 mm in width, and a maximum torque of 20 Nm.(also well hand tightened)





RET SYSTEMS

FOR ELECTRICAL DOWNTILT ANTENNAS

3. Termination load

Termination load shall be connected on the connector 2



Connector 2



Connector 1

Note: When a RACU is first attached to an antenna it is necessary to perform a calibration procedure using the SCU or Software controller, before executing any operation with the RACU (e.g., programming any tilt). The initial calibration procedure is necessary even though the RACU indicate that it is already calibrated.

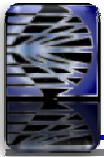

RET SYSTEMS

FOR ELECTRICAL DOWNTILT ANTENNAS

Remote Antenna Control Unit (RACU)

For Electrical Downtilt Antennas



ELECTRICAL SPECIFICATIONS

Unit Model	RACU-001
Interface	RS485
	AISG 1.1
Adjustment Time (Full Range)	60 sec
Power Supply	+10 to +30 V
	5W to 10W (in motion)
	< 1W (idle)

MECHANICAL SPECIFICATIONS

Dimensions mm (in) H X W X D	165 x 65 x 100 (6 X 3 X 4)
Weight kg (lbs)	1.5 (3)
Connectors	2 x 8 pin connector according to IEC 60130-9; according to AISG.
	Daisy chain in: male
	Daisy chain out: female
Housing Material	Aluminium
Grounding	All metallic parts are DC grounded
Temperature Range °C (F)	-40° to +60°C (-40 to +140°)
Humidity	100%



Packing components : Remote Control Unit (RACU) , termination load, extension bar

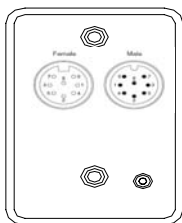

Rear side

Example of configuration with Tri-Band antennas

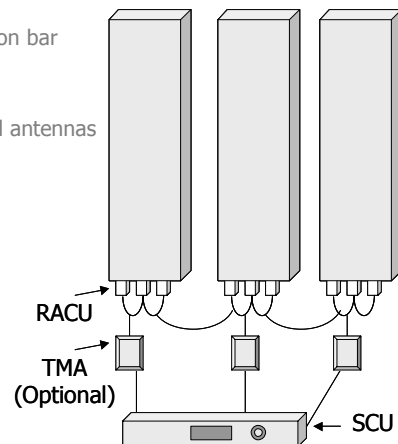

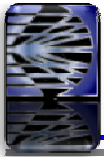

RET SYSTEMS

FOR ELECTRICAL DOWNTILT ANTENNAS

Remote Antenna Control Unit (RACU) For Electrical Downtilt Antennas



ELECTRICAL SPECIFICATIONS

Unit Model	RACU-020
Interface	RS485
	AISG 2.0
Adjustment Time (Full Range)	60 sec
Power Supply	+10 to +30 V
	5W to 10W (in motion)
	< 1W (idle)

MECHANICAL SPECIFICATIONS

Dimensions mm (in) H X W X D	165 X 65 X 100 (6 X 3 X 4)
Weight kg (lbs)	1.5 (3)
Connectors	2 x 8 pin connector according to IEC 60130-9; according to AISG.
	Daisy chain in: male
	Daisy chain out: female
Housing Material	Aluminium
Grounding	All metallic parts are DC grounded
Temperature Range °C (F)	-40° to +60°C (-40 to +140°)
Humidity	100%



Packing components : Remote Control Unit (RACU) , termination load, extension bar

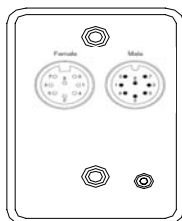

Rear side

Example of configuration with Tri-Band antennas

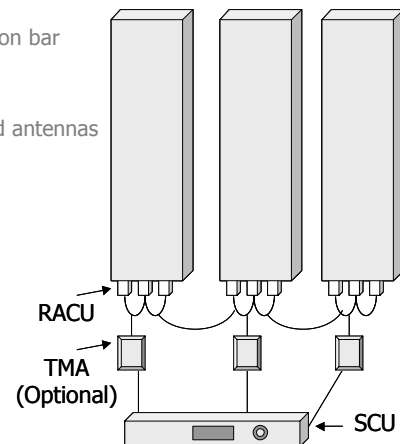

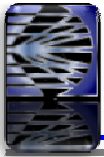

RET SYSTEMS

FOR ELECTRICAL DOWNTILT ANTENNAS

Remote Antenna Control Unit (RACU)

For Electrical Downtilt Antennas



ELECTRICAL SPECIFICATIONS

Unit Model	RACU-003
Interface	RS485
	Ericsson Protocol
Adjustment Time (Full Range)	60 sec
Power Supply	+10 to +30 V
	5W to 10W (in motion)
	< 1W (idle)

MECHANICAL SPECIFICATIONS

Dimensions mm (in) H X W X D	165 X 65 X 100 (6 X 3 X 4)
Weight kg (lbs)	1.5 (3)
Connectors	2 x 8 pin connector according to IEC 60130-9; according to AISG.
	Daisy chain in: male
	Daisy chain out: female
Housing Material	Aluminium
Grounding	All metallic parts are DC grounded
Temperature Range °C (F)	-40° to +60°C (-40 to +140°)
Humidity	100%



Packing components : Remote Control Unit (RACU) , termination load, extension bar

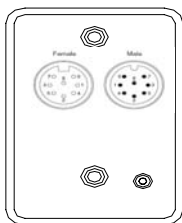

Rear side

Example of configuration with Tri-Band antennas

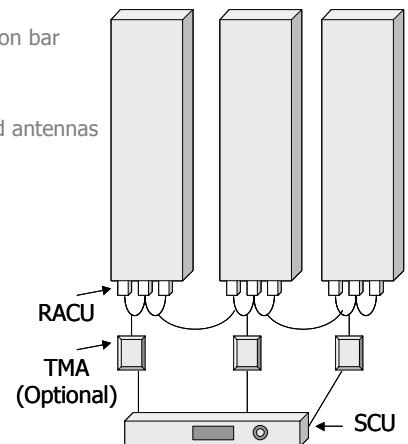

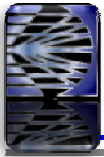

RET SYSTEMS

FOR ELECTRICAL DOWNTILT ANTENNAS



SITE CONTROL UNIT (SCU)

For Remote Control Unit (RACU) and Tower Mounted Amplifier (TMA)

ELECTRICAL SPECIFICATIONS

Site Control Unit Model	SCU-1&2	
Interface to RACU or TMA	AISG 1.1	AISG 2.0
Input Voltage	DC: -48V AC: 100-240 v, 50 to 60 Hz	
Output Voltage	3 x 24 VDC 3 x 12 VDC	
Total Output Power	50 W	
Interface to RACU or TMA	RS-485	
Connector to RACU	3 X 8 pin connectors according to IEC 60130-9; according to AISG. Daisy chain in & out: female.	
Interface to BTS/PC/modem	Ethernet/RS-232	
Protocols to BTS/PC/modem	TCP/IP, HTTP/HTML, UDP, DHCP, FTP, SNMP, ICMP/PING	
Maximum number of ALD	32 logical unit (consumption total < 50W)	
Alarm interface to BTS	Alarms visible at the SCU via LED/ LCD	
	8 configurable opto-isolated alarm signal outputs and common reference return	

MECHANICAL SPECIFICATIONS

Mounting device	Kits for 19 inch rack or wall mounting kit available	
Dimensions	mm (in)	430 x 170 x 43 (17 X 7 X 2)
Weight	kg (lbs)	2.4 (5)
Temperature Range	°C (F)	-25° to +55°C (-13° to 131°)

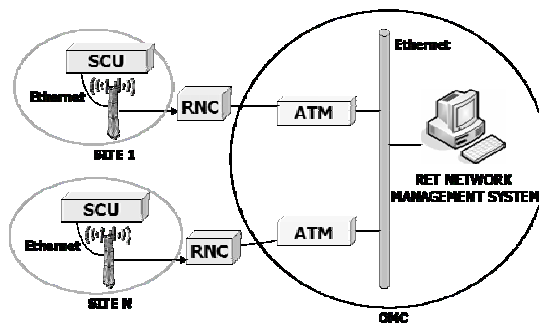



RET SYSTEMS

FOR ELECTRICAL DOWNTILT ANTENNAS

POWER SUPPLY AND CONTROL CABLE



ELECTRICAL SPECIFICATIONS

Type No.	MC XXX
Connectors	2 x 8 pin circular connector according to 60130-9, Ed. 3.0 (in accordance with AISG 1.1), female/male
Construction	Screen 1 x twisted pair 100 Ω/1 MHz 24 AWG 2 x power supply, 1 x DC return 18 AWG
Temperature Range °C (F)	-40 °C to +80°C (- 40° to 176°) (fixed position)
Protection Class	IP 67 (connected)
Cable diameter mm (in)	8 (0.31)
Flammability	VL 1581 VW-1 CSA FT1
Minimum bending radius mm (in)	Single bending 7.5 x D Multiple bending 15 x D

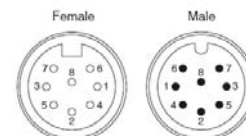

Type No	Description	Length
MC001	Control Cable	1 m (39 in)
MC002	Control Cable	2 m (79 in)
MC003	Control Cable	3 m (118 in)
MC005	Control Cable	5 m (197 in)
MC010	Control Cable	10 m (394 in)
MC020	Control Cable	20 m (787 in)
MC025	Control Cable	25 m (984 in)
MC040	Control Cable	40 m (1575 in)
MC050	Control Cable	50 m (1968 in)
MC060	Control Cable	60 m (2362 in)
MC080	Control Cable	80 m (3150 in)
MC100	Control Cable	100 m (3937 in)

Pin assignment according to AISG

- 1 +13V DC (+12 V DC nominal)
- 2 Optional, not used
- 3 RS 485 B
- 4 RS 485 GND Optional, not used
- 5 RS 485 A
- 6 +29 VDC (+24 V DC nominal)
- 7 DC Return
- 8 Optional not used

- For indoor and outdoor

- Control Cable assembled with suitable connectors for Remote Electrical Tilt (RET) components

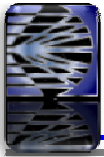

CLAMPS

INSTALLATION INSTRUCTIONS

MATERIAL PROPERTIES.

Below is a table showing the characteristics of various materials used for the entire clamp assembly.

Element / Elemento	Material
Agarres / Grips	Fundición nodular / Nodular cast iron 60-40-18
Tijeras / scissors	Acero / Iron S235
Grapas / staples	Fundición nodular / Nodular cast iron 60-40-18

All parts are treated with hot dip galvanizing to withstand the weather conditions that they may be exposed to in extreme heat and cold weather conditions.

OTHER INFORMATION:

The weight of the clamps for pole mounting small antennas is 7.7 lbs, the larger antennas have clamps that weigh 15.4 lbs. The weight of the clamps for the YAGI antennas is 2 lbs.

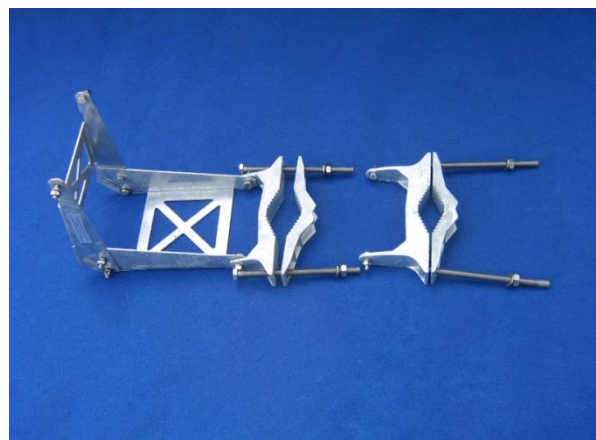



CLAMPS

BIG CLAMPS

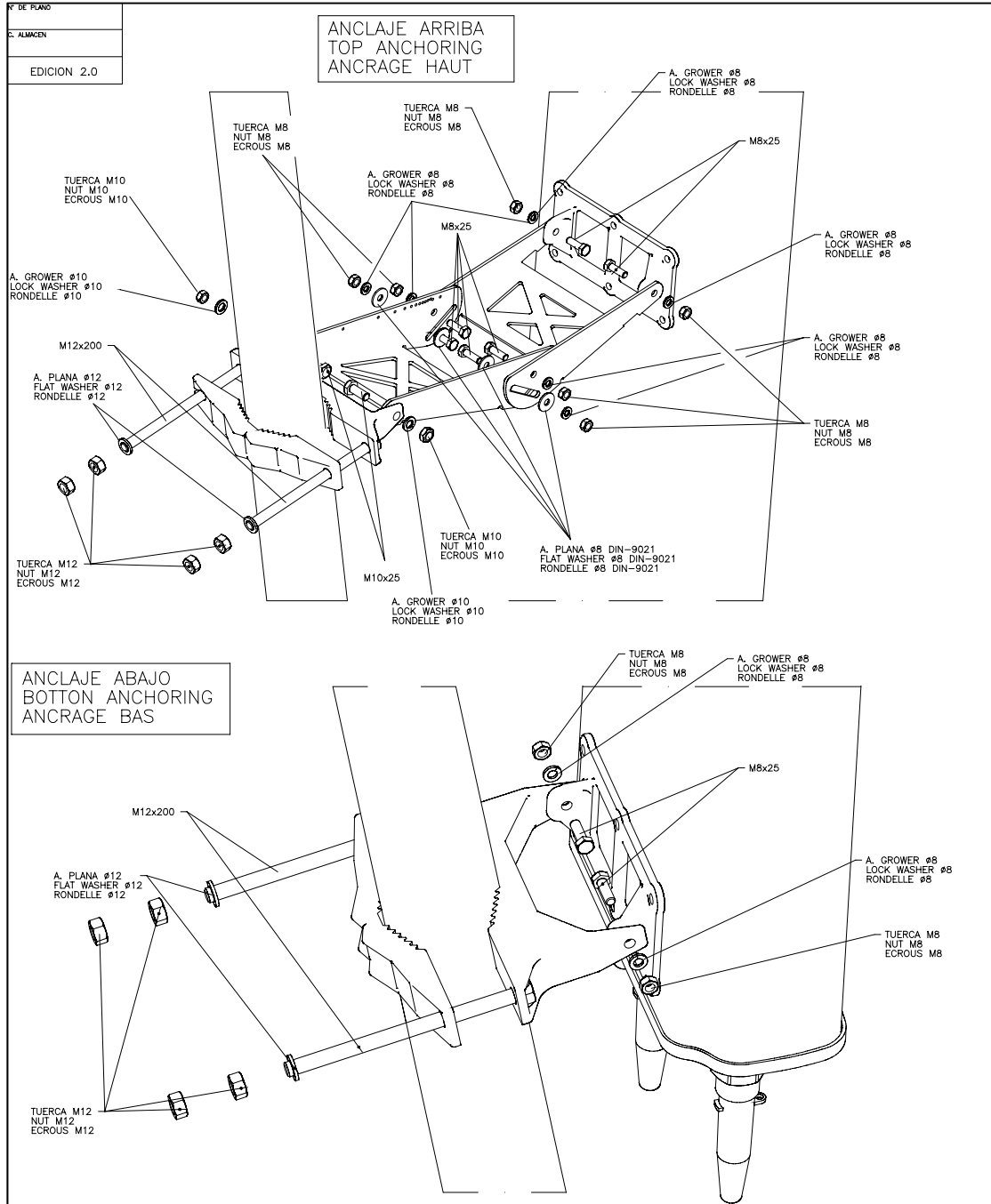

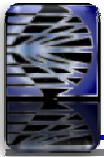

CLAMPS

BIG CLAMPS

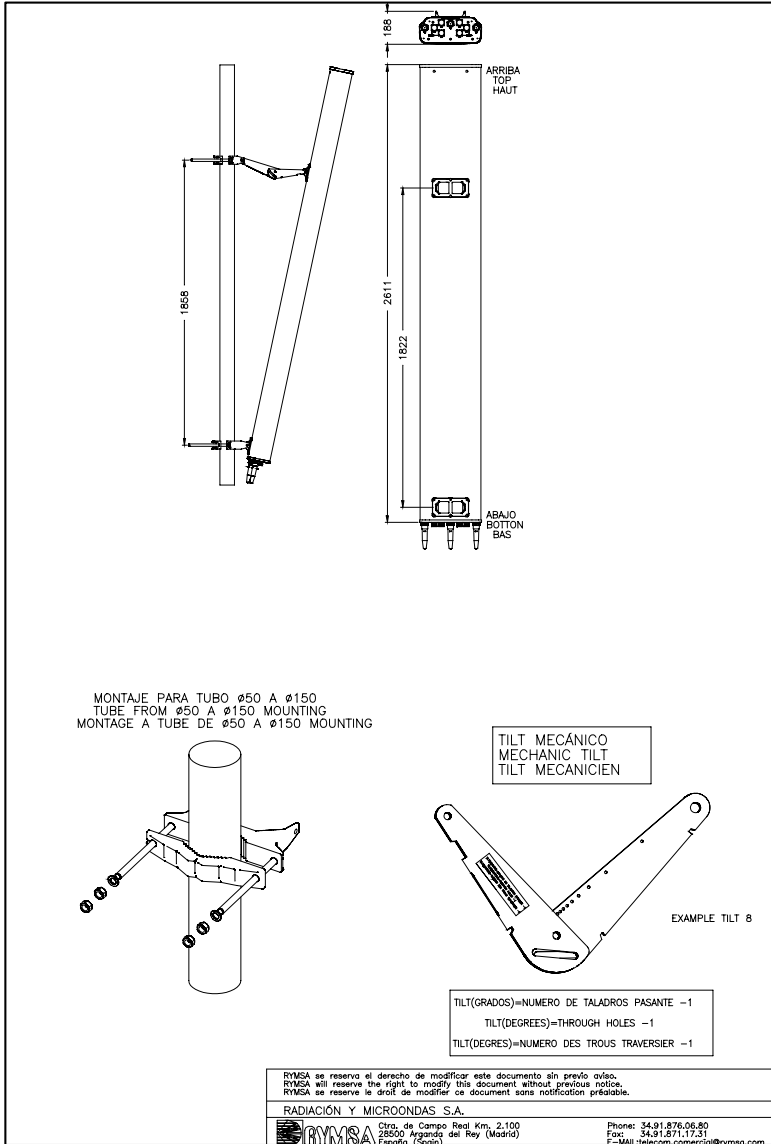

BIG CLAMPS FOR THE FAMILY OF ANTENNAS:
AT-66X
AT-68X
MGV1-800TX
MGD1-800TX
TT/TG/TGA/TGA2
BGRD3A-800
BGD3-400
MG3D3
PT1/PT2
QB1/QB2
BG4

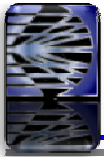

CLAMPS

SMALL CLAMPS

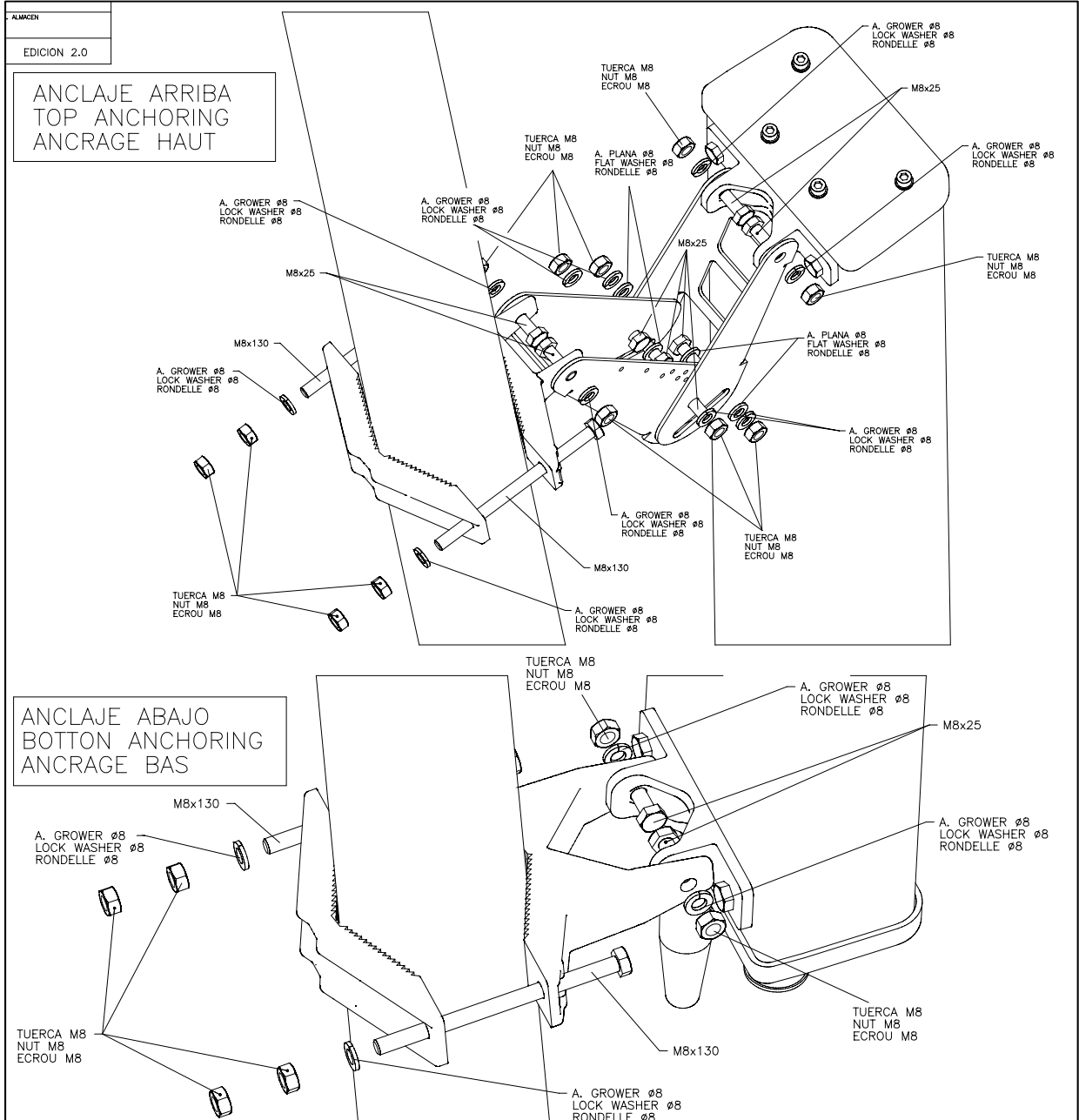

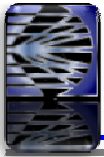

CLAMPS

SMALL CLAMPS

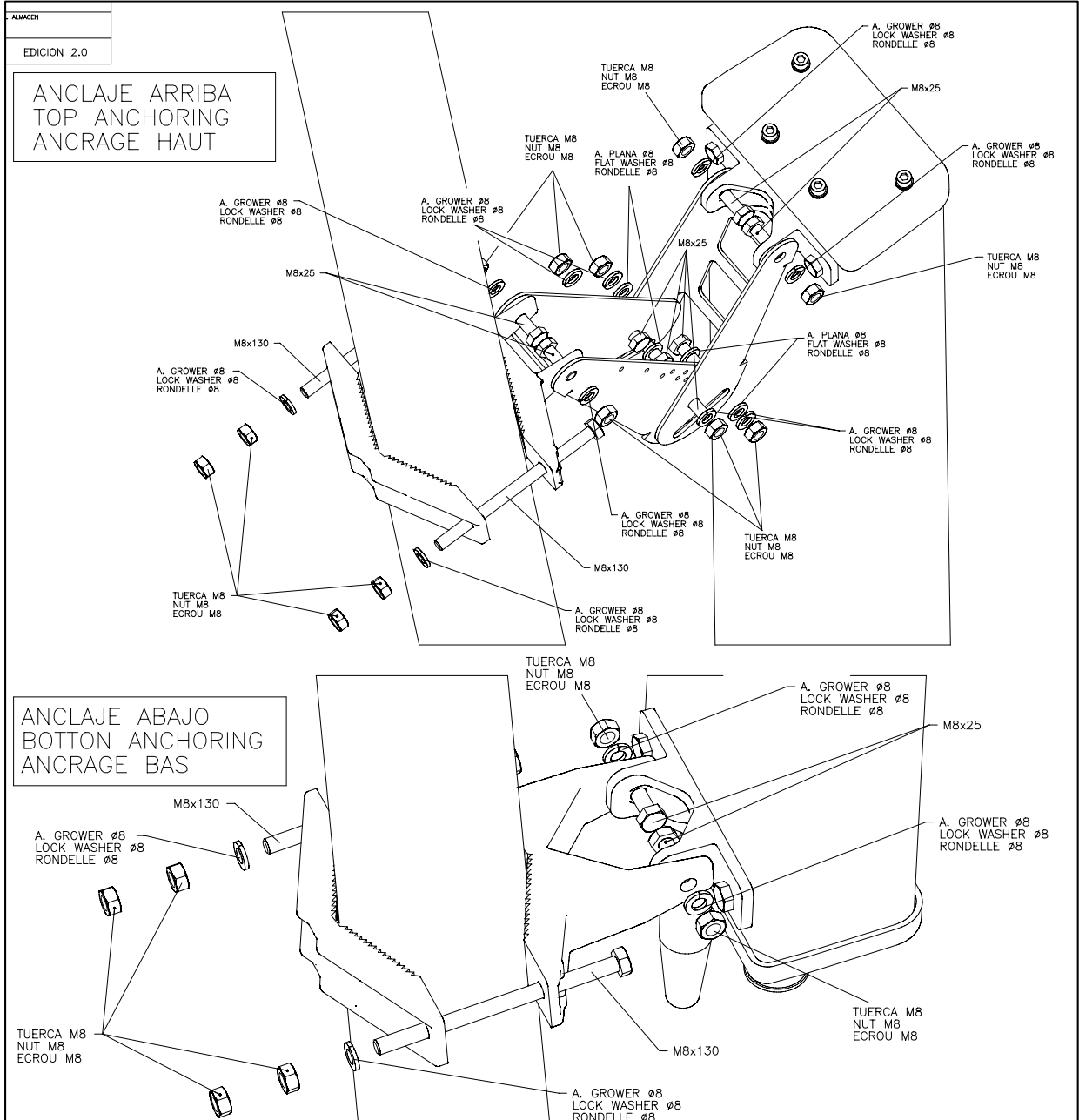

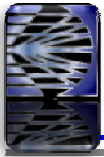

CLAMPS

SMALL CLAMPS

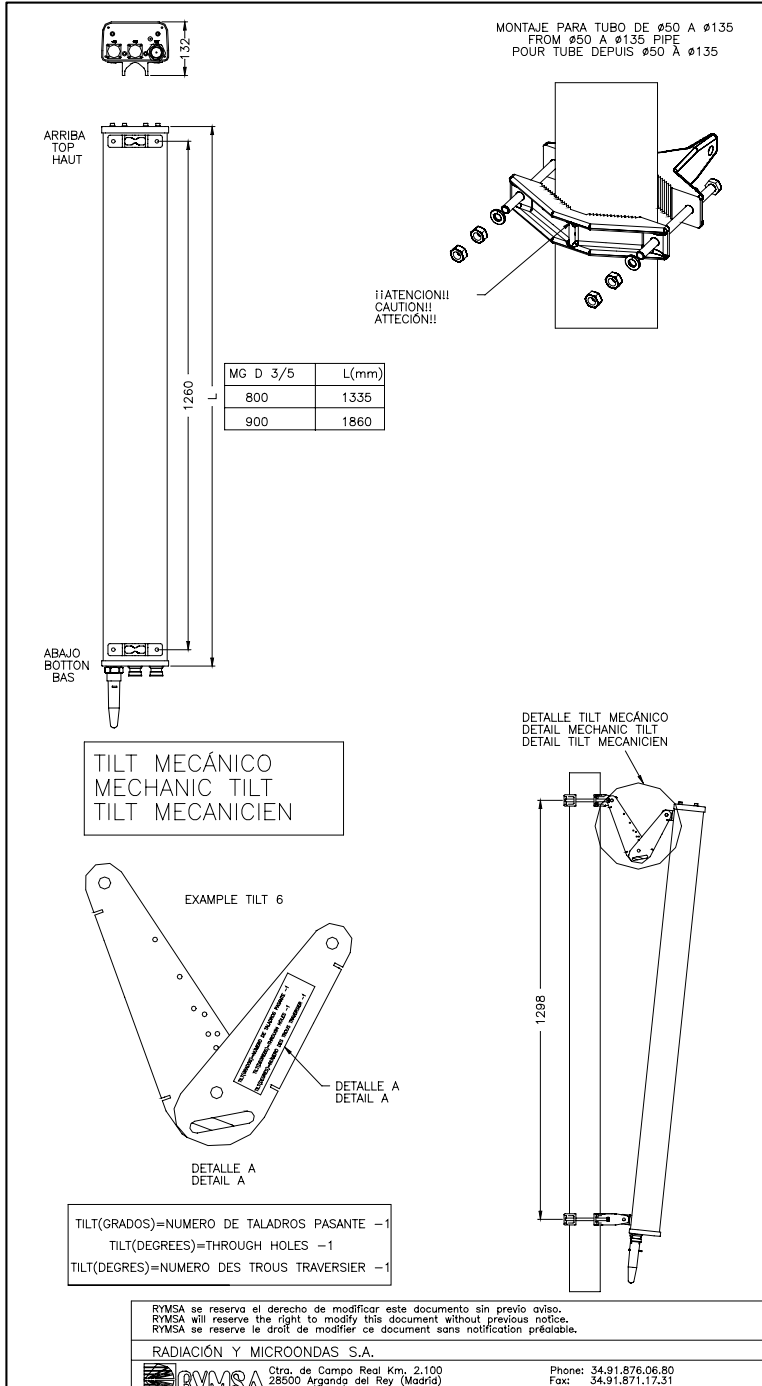

SMALL CLAMPS FOR THE FAMILY OF ANTENNAS:

AT-64X
MGD3-900
MGV3-900
MGD / MGX
BGD3-800

RYMSA Wireless

15 Caron Street
Merrimack,
NH 03054, USA
+1 888 622 6095
+1 603 429 1633 (Fax)
sales@rymsawireless.com
www.rymsawireless.com

RYMSA Group –Headquarters (Spain)

Ctra. Campo Real Km 2,100
Arganda del Rey
28500 Madrid, Spain
+ 34 91 876 06 80
+ 34 91 875 75 32 (fax)
telecom.commercial@rymsa.com
www.rymsa.com



RYMSA México (RYMEX)

Prolog. Recursos Hidráulicos 1-E
Colonia La Loma
CP 54060 Tlalnepantla
Edo. De México, México
+52 55 1106 2623
+52 55 1106 2077 (fax)
telecom.commercial@rymsa.com
www.rymsa.com



www.rymsa.com

RYMSA Group –Headquarters (Spain)

Ctra. Campo Real Km 2,100

Arganda del Rey

28500 Madrid, Spain

+ 34 91 876 06 80

+ 34 91 875 75 32 (fax)

telecom.commercial@rymsa.com

www.rymsa.com

RYMSA México (RYMEX)

Prolg. Recursos Hidráulicos 1-E

Colonia La Loma

CP 54060 Tlalnepantla

Edo. De México, México

+52 55 1106 2623

+52 55 1106 2077 (fax)

telecom.commercial@rymsa.com

www.rymsa.com

RYMSA Wireless (USA)

15 Caron Street

Merrimack,

NH 03054, USA

+1 888 622 6095

+1 603 429 1633 (Fax)

sales@rymsawireless.com

www.rymsawireless.com